



VARDEX

Fortschrittliche Gewindelösungen



Dreh-und Fräswerkzeuge

Gewinden | Einstechen | Ausdrehen

Hauptkatalog

METRISCH

NEU IN DIESEM KATALOG

NEUE VOLLHARTMETALLWERKZEUGE

HELICOOL FAMILIE

► **Helicool**
gedrallt mit axialem Kühlmittelaustritt



► **Helicool-R (HCR)**
radialer Kühlmittelaustritt



► **Helicool-C (HCC)**
Gewinden + Fasen in Einem



► **Thriller (HTC)**
Bohren, Gewinden +
Fasen in Einem



Siehe Seite 292

MILLIPRO FAMILIE

► Miniaturgewindefräser



Siehe Seite 305

TIEFE GEWINDE FRÄSEN

► bis zu 3 x D Tiefe



Siehe Seite 304

HELICAL

► kostengünstiges Werkzeug
für Durchgangslöcher



Siehe Seite 300

MULTI+SCHNEIDPLATTEN

► verbesserte Geometrie
für Mehrzahnplatten

Siehe Seiten 17-95

Multiplus



M+



T+



Z+

MINI-3 IC4.0

► Wechselgewindefräser für
kleine Durchmesser



Siehe Seiten 17-95

V6 SCHNEIDPLATTEN

► Das revolutionäre
6-Schneiden-System



Siehe Seiten 17-95

V6

TMSD

► Gewindefräser für tiefe Gewinde



Siehe Seite 273

MICROSCOPE

► neues, verbessertes Spannsystem für
einschneidige Micro-Werkzeuge



Siehe Seite 17-123

microscope

MiTM FAMILIE

► Multi Flute Indexable
Thread Milling für schnelle Bearbeitungen



Siehe Seite 253

VARDEX KATALOG

VARDEX DREHEN

KAPITEL

■ Gewindedrehen 6-146

■ Stechen 147-170

■ Ausdrehen 171-192

VARDEX FRÄSEN

■ Gewindefräsen Standard 193-252

■ MiTM - Multi-Flute Indexable Thread Mill Inserts 253-272

■ TMSD - Gewindefräser für tiefe Bohrungen 273-288

■ TM Solid - Vollhartmetal Gewindefräser 289-320

■ Stechfräsen 321-328

Bitte besuchen Sie unsere Website: www.vargus.de



Die NUMMER EINS im Gewindedrehen

VARGUS ist ein weltweit führender Entwickler, Hersteller und Lieferant von qualitativ hochwertigen Präzisionsschneid- und -entgratungswerkzeugen. Der Produktbereich VARDEX ist der weltweit wichtigste Lieferant für Gewindedrehlösungen und verfügt über die größte Produktpalette für das Gewindedrehen und Gewindefräsen sowie über ein umfangreiches Angebot für den Bereich Microbearbeitung.

Gegründet im Jahre 1960 ist VARGUS ein Mitglied der NEUMO EHRENBERG GROUP, einem diversifizierten multinationalen Unternehmen mit Stammhaus in Knittlingen, Deutschland. Mit einem Netzwerk von internationalen Vertriebsniederlassungen, Lagern und ISO 9001 zertifizierten Produktionsstätten bedient VARGUS Kunden in mehr als 100 Ländern rund um den Globus und bietet schnelle Lieferzeiten sowie engagierten Kundenservice.

Vargus ist ein kundenorientiertes Unternehmen mit dem Anspruch, innovative Produkte von höchster Qualität und großem Wert sowie erstklassigen Service und technisches Können zu bieten. Diese Kernwerte haben Vargus geholfen, Marktführer für Gewindelösungen zu bleiben. Sie werden uns auch weiterhin auf unserem Geschäftsweg führen.



VarDEX Sonder-Werkzeuge

Die Ingenieure und Werkzeugmacher von VARDEX besitzen das Know-how und die Erfahrung, um spezielle Schneidwerkzeuge, abgestimmt auf die Anforderungen der Kunden, zu entwickeln. Ob es sich dabei um eine spezielle komplexe Form oder eine nicht- standardisierte Größe handelt n unser Spezialwerkzeugservice kann mit Hilfe neuester Techniken und Technologien schnell das von Ihnen benötigte Werkzeug herstellen.

Für spezielle Details wenden Sie sich bitte an Ihre nächste VARGUS Vertretung.

- VARDEX-Erfahrung
- Schnelle Angebotserstellung
- Konkurrenzfähige Lieferung

Sonderfertigung



DREHEN

■ Gewindedrehsysteme.....	Seite 6
■ Werkzeugempfehlung.....	Seite 8

Gewindedrehen

■ Gewindedrehplatten	Seite 17
■ Gewindedrehhalter	Seite 97
■ Technische Daten – Gewindedrehen.....	Seite 125

Stechen

■ Einstechplatten	Seite 147
■ Einstechhalter.....	Seite 163
■ Technische Daten – Stechen	Seite 169

Ausdrehen

■ Wendeplatten & Einsätze für die Innenbearbeitung.....	Seite 171
■ Bohrstangen.....	Seite 181
■ Technische Daten – Innenbearbeitung.....	Seite 189

TT Gen: Vereinfacht die Komplexität in der Gewindefertigung!

TT Gen:

Software zur Auswahl von Gewindedrehwerkzeugen

VARGUS TT Gen ermöglicht Ihnen in kurzer Zeit die Auswahl des richtigen Werkzeuges und der optimalen Schnittdaten für Ihre Anwendung.

Download unter
www.vargus.de



Drehen

- > Gewindedrehen
- > Stechen
- > Ausdrehen

Gewindedrehsystem – aussen

Standard

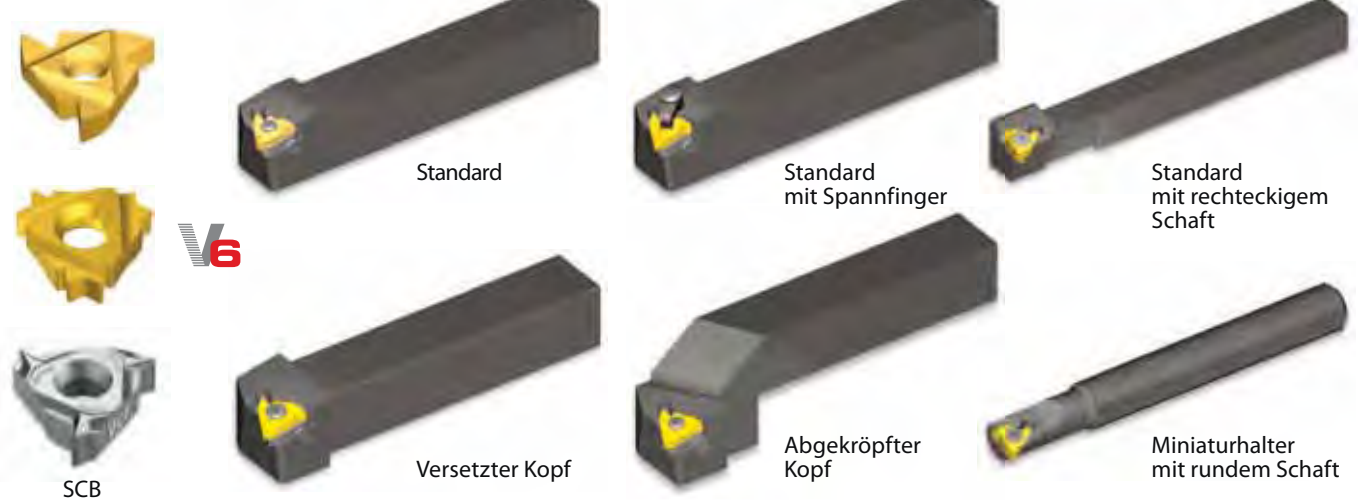

U Typ



V Typ



M+ Typ

Multiplus



Z+ Typ

Multiplus



T+ Typ

Multiplus



Gewindedrehsystem – innen

Standard



Standard



API



Miniaturhalter mit rechteckigem Schaft



Standard mit Spannfinger



Hartmetall-Schaft



Miniaturhalter mit rundem Schaft

U Typ



U Typ



U Typ mit Spannfinger

V Typ



V Typ

M+ Typ



M+ Typ

T+ Typ



T+ Typ

Z+ Typ



Z+ Typ

Mini-3 - Gewinde



Mini-3 - Gewinde



Mini-3 – Halter verstellbar

Mini-L



Mini-L



Mini-L – Halter verstellbar

MicroThread



microscope



Micro Gewindeschneideinsätze einseitig



Micro Micro Gewindeschneideinsätze zweiseitig



Werkzeugempfehlung für das Innengewindedrehen

Downloads von TT Gen
und Updates
unter www.vargus.de



ISO metrisch

Teilung mm	Gewinde	Plattengröße	Bestellnummer		
			Wendeplatte	Halter	Unterlegplatte
0.70	4	Micro 3.0	3.0SIR0.7ISO	SMC...-3	-
	6	Micro 4.0	4.0SIR0.75ISO	SMC...-4	-
0.75	8	Micro 6.0	6.0SIR0.75ISO	SMC...-6	-
	10	IC 5.0 L	5LIR0.75ISO	.NVR10.-5L	-
0.80	5	Micro 3.0	3.0SIR0.8ISO	SMC...-3	-
	M6	Micro 4.0	4.0SIR1.0ISO	SMC...-4	-
	8	Micro 6.0	6.0SIR1.0ISO	SMC...-6	-
1.00	10	IC 5.0 L	5LIR1.0ISO	.NVR10.-5L	-
	12-14	IC 6.0	6.0IR1.0ISO	.NVR1...-6.0	-
	15-17	IC 1/4"	2IR1.0ISO	NVR10-2	-
	18	IC 1/4"	2IR1.0ISO	NVR13-2	-
	20-24	IC 3/8"	3IR1.0ISO	NVR13-3	-
	M8	Micro 6.0	6.0SIR1.25ISO	SMC...-6.0	-
1.25	10	IC 5.0 L	5LIR1.25ISO	.NVR10.-5L	-
	12-14	IC 6.0	6.0IR1.25ISO	.NVR1...-6.0	-
	M10	IC 5.0 L	5LIR1.5ISO	.NVR10.-5L	-
1.50	12-14	IC 6.0	6.0IR1.5ISO	.NVR1...-6.0	-
	15-18	IC 1/4"	2IR1.5ISO	NVR10-2	-
	20-25	IC 3/8"	3IR1.5ISO	NVR13-3	-
	26-28	IC 3/8"	3IR1.5ISO	AVR20-3	Y13
	30-36	IC 3/8"	3IR1.5ISO	AVR20-3	Y13-1N
	38-45	IC 3/8"	3IR1.5ISO	AVR32-3	Y13-1N
	48-68	IC 3/8"	3IR1.5ISO	AVR40-3	Y13-1N
1.75	M12	IC 6.0	6.0IR1.75ISO	.NVR1...-6.0	-
	M14	IC 6.0	6.0IR2.0ISO	.NVR1...-6.0	-
	M16-18	IC 1/4"	2IR2.0ISO	NVR10-2	-
	20-22	IC 3/8"	3IR2.0ISO	NVR13-3	-
2.00	24	IC 3/8"	3IR2.0ISO	NVR16-3	-
	27-30	IC 3/8"	3IR2.0ISO	AVR20-3	Y13
	33-36	IC 3/8"	3IR2.0ISO	AVR25-3	Y13
	39-45	IC 3/8"	3IR2.0ISO	AVR32-3	Y13-1N
	48-68	IC 3/8"	3IR2.0ISO	AVR40-3	Y13-1N
	M18	IC 1/4"	2IR2.5ISO	NVR10-2	-
2.50	M20-M22	IC 3/8"	3IR2.5ISO	NVR13-3	-
	M24-M27	IC 3/8"	3IR3.0ISO	NVR16-3	-
3.00	36-45	IC 3/8"	3IR3.0ISO	AVR25-3	Y13
	48-68	IC 3/8"	3IR3.0ISO	AVR40-3	Y13
3.50	M30-M33	IC 3/8"	3IR3.5ISO	NVR16-3	-
	M36	IC 1/2"	4IR4.0ISO	NVR20-4	-
4.00	M39	IC 1/2"	4IR4.0ISO	AVR25-4	Y14
	56-68	IC 1/2"	4IR4.0ISO	AVR40-4	Y14
4.50	M42	IC 1/2"	4IR4.5ISO	AVR25-4	Y14-1P
	M45	IC 1/2"	4IR4.5ISO	AVR32-4	Y14
5.00	M48	IC 1/2"	4IR5.0ISO	AVR32-4	Y14-1P
	M52	IC 1/2"	4IR5.0ISO	AVR32-4	Y14
5.50	M56-60	IC 5/8"	5IR5.5ISO	AVR40-5	Y15
6.00	M64-68	IC 5/8"	5IR6.0ISO	AVR40-5	Y15

Werkzeugempfehlung für das Innengewindedrehen

Downloads von TT Gen
und Updates
unter www.vargus.de



Amerikanisch UN

Teilung G/Z	Gewinde	Plattengröße	Bestellnummer		
			Wendeplatte	Halter	Unterlegplatte
56	10 - 1/4	Micro 4.0	Special	SMC..-4.0	-
48	10 - 5/16	Micro 4.0	Special	SMC..-4.0	-
40	10 - 3/8	Micro 4.0	4.0SIR40UN	SMC..-4.0	-
36	12 - 3/8	Micro 4.0	4.0SIR36UN	SMC..-4.0	-
	12 - 1/4	Micro 4.0	4.0SIR32UN	SMC..-4.0	-
	5/16 - 3/8	Micro 6.0	6.0SIR32UN	SMC..-6.0	-
	7/16 - 1/2	IC 6.0	6.0IR32UN	.NVR 1..-6.0	-
32	9/16 - 11/16	IC 1/4"	2IR32UN	NVR10-2	-
	3/4 - 15/16	IC 3/8"	3IR32UN	NVR13-3	-
	7/8 - 15/16	IC 3/8"	3IR32UN	NVR16-3	-
	1	IC 3/8"	3IR32UN	AVR20-3	Y13 - 1N
	12 - 1/4	Micro 4.0	4.0SIR28UN	SMC..-4.0	-
	5/16 - 3/8	Micro 6.0	6.0SIR28UN	SMC..-6.0	-
	7/16 - 1/2	IC 6.0	6.0IR28UN	.NVR 1..-6.0	-
28	5/8 - 11/16	IC 1/4"	2IR28UN	NVR10-2	-
	3/4 - 13/16	IC 3/8"	3IR28UN	NVR13-3	-
	7/8 - 15/16	IC 3/8"	3IR28UN	NVR16-3	-
	1 - 1 1/8	IC 3/8"	3IR28UN	AVR20-3	Y13 - 1N
	1 3/16	IC 3/8"	3IR28UN	AVR25-3	Y13 - 1N
	1/4	Micro 4.0	4.0SIR27UN	SMC..-4.0	-
	5/16 - 3/8	Micro 6.0	6.0SIR27UN	SMC..-6.0	-
	7/16 - 1/2	IC 6.0	Special	.NVR 1..-6.0	-
27	9/16 - 5/8	IC 1/4"	2IR27UN	NVR10-2	-
	3/4	IC 3/8"	3IR27UN	NVR13-3	-
	7/8	IC 3/8"	3IR27UN	NVR16-3	-
	1	IC 3/8"	3IR27UN	AVR20-3	Y13 - 1N
	12 - 1/4	Micro 4.0	4.0SIR24UN	SMC..-4.0	-
	5/16 - 3/8	Micro 6.0	6.0SIR24UN	SMC..-6.0	-
	7/16	IC 5.0 L	5LIR24UN	.NVR10..-5L	-
	1/2	IC 6.0	6.0IR24UN	.NVR 1..-6.0	-
24	9/16 - 11/16	IC 1/4"	2IR24UN	NVR10-2	-
	3/4	IC 3/8"	3IR24UN	NVR13-3	-
	7/8	IC 3/8"	3IR24UN	NVR16-3	-
	1 - 1 1/8	IC 3/8"	3IR24UN	AVR20-3	Y13 - 1N
	1 1/4 - 1 1/2	IC 3/8"	3IR24UN	AVR25-3	Y13 - 1N
	1 5/8 - 24	IC 3/8"	3IR24UN	AVR32-3	Y13 - 1N
	5/16 - 3/8	Micro 6.0	6.0SIR20UN	SMC..-6.0	-
	7/16	IC 5.0 L	5LIR20UN	.NVR10..-5L	-
	1/2 - 9/16	IC 6.0	6.0IR20UN	.NVR 1..-6.0	-
20	5/8 - 11/16	IC 1/4"	2IR20UN	NVR10-2	-
	3/4 - 13/16	IC 3/8"	3IR20UN	NVR13-3	-
	7/8 - 15/16	IC 3/8"	3IR20UN	NVR16-3	-
	1 - 1 3/16	IC 3/8"	3IR20UN	AVR20-3	Y13 - 1N
	1 1/4 - 1 1/2	IC 3/8"	3IR20UN	AVR25-3	Y13 - 1N
	1 9/16 - 1 13/16	IC 3/8"	3IR20UN	AVR32-3	Y13 - 1N
	1 7/8 - 2 1/8	IC 3/8"	3IR20UN	AVR40-3	Y13 - 1N

Werkzeugempfehlung für das Innengewindedrehen

Downloads von TT Gen
und Updates
unter www.vargus.de



American UN (Forts.)

Teilung G/Z	Gewinde	Plattengröße	Bestellnummer		
			Wendeplatte	Halter	Unterlegplatte
18	5/16 - 3/8	Micro 6.0	6.0SIR18UN	SMC..-6.0	-
	7/16	IC 5.0 L	5LIR18UN	.NVR10.-5L	-
	1/2 - 9/16	IC 6.0	6.0IR18UN	.NVR 1..-6.0	-
	5/8	IC 1/4"	2IR18UN	NVR10-2	-
	3/4	IC 3/8"	3IR18UN	NVR13-3	-
	7/8 - 1	IC 3/8"	3IR18UN	NVR16-3	-
	1 1/16 - 1 3/16	IC 3/8"	3IR18UN	AVR20-3	YI3 - 1N
	1 1/4 - 1 1/2	IC 3/8"	3IR18UN	AVR25-3	YI3 - 1N
	1 9/16 - 1 3/4	IC 3/8"	3IR18UN	AVR32-3	YI3 - 1N
16	1 7/8 - 2	IC 3/8"	3IR18UN	AVR40-3	YI3 - 1N
	3/8	Micro 6.0	6.0SIR16UN	SMC..-6.0	-
	7/16	IC 5.0 L	5LIR16UN	.NVR10.-5L	-
	1/2 - 9/16	IC 6.0	6.0IR16UN	.NVR 1..-6.0	-
	5/8 - 11/16	IC 1/4"	2IR16UN	NVR10-2	-
	3/4 - 13/16	IC 3/8"	3IR16UN	NVR13-3	-
	7/8 - 1	IC 3/8"	3IR16UN	NVR16-3	-
	1 1/16 - 1 1/8	IC 3/8"	3IR16UN	AVR20-3	YI3
	1 3/16	IC 3/8"	3IR16UN	AVR20-3	YI3 - 1N
	1 1/4 - 1 1/2	IC 3/8"	3IR16UN	AVR25-3	YI3 - 1N
14	1 9/16 - 1 13/16	IC 3/8"	3IR16UN	AVR32-3	YI3 - 1N
	1 7/8 - 2 1/8	IC 3/8"	3IR16UN	AVR40-3	YI3 - 1N
	7/16	IC 5.0 L	5LIR14UN	.NVR10.-5L	-
	1/2 - 9/16	IC 6.0	6.0IR14UN	.NVR 1..-6.0	-
	5/8	IC 1/4"	2IR14UN	NVR10-2	-
	3/4	IC 3/8"	3IR14UN	NVR13-3	-
	7/8 - 1	IC 3/8"	3IR14UN	NVR16-3	-
	1 1/8	IC 3/8"	3IR14UN	AVR20-3	YI3
	1 1/4	IC 3/8"	3IR14UN	AVR25-3	YI3
13	1 3/8 - 1 1/2	IC 3/8"	3IR14UN	AVR25-3	YI3 - 1N
	1 5/8 - 1 3/4	IC 3/8"	3IR14UN	AVR32-3	YI3 - 1N
	1 7/8 - 2	IC 3/8"	3IR14UN	AVR40-3	YI3 - 1N
	1/2 - 13	IC 6.0	6.0I13UN...158/001	BNVR 10S-6.0	-
	9/16 - 11/16	IC 1/4"	2I12UN...158/002	NVRC10-2 156/001	-
	3/4 - 7/8	IC 3/8"	3IR12UN	NVR13-3	-
	15/16 - 1	IC 3/8"	3IR12UN	NVR16-3	-
12	1 1/16 - 1 3/16	IC 3/8"	3IR12UN	AVR20-3	YI3
	1 1/4 - 1 1/2	IC 3/8"	3IR12UN	AVR25-3	YI3
	1 9/16 - 1 13/16	IC 3/8"	3IR12UN	AVR32-3	YI3
	1 7/8 - 2 1/8	IC 3/8"	3IR12UN	AVR40-3	YI3 - 1N
	5/8 - 11	IC 1/4U"	2UIR11UN...158/003	NVRC11-2U 156/002	-
11	7/8	IC 3/8"	3IR10UN	NVR13-3	-
	1 - 10	IC 3/8"	3IR10UN	NVR16-3	-
	1 1/8 - 10	IC 3/8"	3IR10UN	AVR20-3	YI3
	1 1/4 - 1 1/2	IC 3/8"	3IR10UN	AVR25-3	YI3
	1 5/8 - 1 3/4	IC 3/8"	3IR10UN	AVR32-3	YI3
	1 7/8 - 2	IC 3/8"	3IR10UN	AVR40-3	YI3

Werkzeugempfehlung für das Innengewindedrehen

Downloads von TT Gen
und Updates
unter www.vargus.de



American UN (Forts.)

Teilung G/Z	Gewinde	Plattengröße	Bestellnummer		
			Wendeplatte	Halter	Unterlegplatte
9	7/8 - 9	IC 3/8"	3IR9UN	NVR13-3	-
	1	IC 3/8"	3IR8UN	NVR16-3	-
8	1 1/16 - 1 3/16	IC 3/8"	3IR8UN	AVR20-3	Y13 - 1P
	1 1/4	IC 3/8"	3IR8UN	AVR20-3	Y13
	1 5/16 - 1 1/2	IC 3/8"	3IR8UN	AVR25-3	Y13
	1 9/16 - 1 13/16	IC 3/8"	3IR8UN	AVR32-3	Y13
	1 7/8 - 2 1/8	IC 3/8"	3IR8UN	AVR40-3	Y13
7	1 1/8 - 1 1/4	IC 1/2"	4IR7UN	NVR20-4	-
	1 3/8 - 1 7/16	IC 1/2"	4IR6UN	NVR20-4	-
	1 1/2 - 1 5/8	IC 1/2"	4IR6UN	AVR25-4	Y14-1P
6	1 11/16	IC 1/2"	4IR6UN	AVR25-4	Y14
	1 3/4 - 2	IC 1/2"	4IR6UN	AVR32-4	Y14
	2 1/8 - 6	IC 1/2"	4IR6UN	AVR40-4	Y14
	5	1 3/4 - 5	IC 1/2"	4IR5UN	AVR25-4
4.5	2 - 4 1/2	IC 5/8"	5IR4.5UN	AVR32-5	Y15 - 1P

Werkzeugempfehlung für das Innengewindedrehen

Downloads von TT Gen
und Updates
unter www.vargus.de



Whitworth

Teilung G/Z	Gewinde	Plattengröße	Bestellnummer		
			Wendeplatte	Halter	Unterlegplatte
26	1/4	Micro 4.0	4.0SIR26W	SMC.-4.0	-
	5/16 - 1/2	Micro 6.0	6.0SIR26W	SMC.-6.0	-
	9/16 - 5/8	IC 1/4"	2IR26W	NVR10-2	-
	11/16	IC 1/4"	2IR26W	NVR13-2	-
	3/4 - 13/16	IC 3/8"	3IR26W	NVR13-3	-
	7/8 - 15/16	IC 3/8"	3IR26W	NVR16-3	-
	1 - 1 3/16	IC 3/8"	3IR26W	AVR20-3	Y13 - 1N
	1 1/4 - 1 7/16	IC 3/8"	3IR26W	AVR25-3	Y13 - 1N
	1 1/2 - 1 3/4	IC 3/8"	3IR26W	AVR32-3	Y13 - 1N
22	1 7/8 - 2	IC 3/8"	3IR26W	AVR40-3	Y13 - 1N
	5/16	Micro 6.0	6.0SIR22W	SMC.-6.0	-
	3/8 - 9/16	Micro 6.0	6.0SIR20W	SMC.-6.0	-
	5/8 - 11/16	IC 1/4"	2IR20W	NVR10-2	-
	3/4 - 13/16	IC 3/8"	3IR20W	NVR13-3	-
	7/8 - 1	IC 3/8"	3IR20W	NVR16-3	-
	1 1/16 - 1 3/16	IC 3/8"	3IR20W	AVR20-3	Y13 - 1N
	1 1/4 - 1 7/16	IC 3/8"	3IR20W	AVR25-3	Y13 - 1N
	1 1/2 - 1 3/4	IC 3/8"	3IR20W	AVR32-3	Y13 - 1N
20	1 7/8 - 3	IC 3/8"	3IR20W	AVR40-3	Y13 - 1N
	11/16	IC 1/4"	2IR16W	NVR10-2	-
	3/4 - 11/16	IC 3/8"	3IR16W	NVR13-3	-
	7/8 - 1	IC 3/8"	3IR16W	NVR16-3	-
	1 1/16 - 1 1/8	IC 3/8"	3IR16W	AVR20-3	Y13
	1 3/16	IC 3/8"	3IR16W	AVR20-3	Y13 - 1N
	1 1/4 - 1 7/16	IC 3/8"	3IR16W	AVR25-3	Y13 - 1N
	1 1/2 - 1 3/4	IC 3/8"	3IR16W	AVR32-3	Y13 - 1N
	1 7/8 - 4 5/8	IC 3/8"	3IR16W	AVR40-3	Y13 - 1N
16	4 3/4 - 7	IC 3/8"	3IR16W	AVR40-3	Y13 - 1.5N
	7/16	IC 5.0 L	5LIR14W	.NVR10.-5L	-
	5/8 - 11/16	IC 1/4"	2IR14W	NVR10-2	-
	13/16	IC 3/8"	3IR12W	NVR13-3	-
	15/16 - 1	IC 3/8"	3IR12W	NVR16-3	-
	1 1/16 - 1 3/16	IC 3/8"	3IR12W	AVR20-3	Y13
	1 1/4 - 1 1/2	IC 3/8"	3IR12W	AVR25-3	Y13
	1.6 - 1 3/4	IC 3/8"	3IR12W	AVR32-3	Y13 - 1N
	1 7/8 - 6	IC 3/8"	3IR12W	AVR40-3	Y13 - 1N
14	6 1/4 - 7	IC 3/8"	3IR12W	AVR40-3	Y13 - 1.5N
	7/8	IC 3/8"	3IR11W	NVR13-3	-
11	1	IC 3/8"	3IR10W	NVR16-3	-
10					

Werkzeugempfehlung für das Innengewindedrehen

Downloads von TT Gen
und Updates
unter www.vargus.de



Whitworth (Forts.)

Teilung G/Z	Gewinde	Plattengröße	Wendeplatte	Bestellnummer	Unterlegplatte
9	7/8	IC 3/8"	3IR9W	NVR13-3	-
	1 1/8 - 1 1/4	IC 3/8"	3IR9W	AVR20-3	Y13
8	1	IC 3/8"	3IR8W	NVR16-3	-
	1 3/16	IC 3/8"	3IR8W	AVR20-3	Y13 - 1P
	1 5/16 - 1 1/2	IC 3/8"	3IR8W	AVR25-3	Y13
	1.6 - 1 7/8	IC 3/8"	3IR8W	AVR32-3	Y13
	1.9 - 2 1/4	IC 3/8"	3IR8W	AVR40-3	Y13
	2.4 - 7	IC 3/8"	3IR8W	AVR40-3	Y13 - 1N
7	1 1/4	IC 1/2"	4IR7W	NVR20-4	-
	1 3/4 - 2	IC 1/2"	4IR7W	AVR32-4	Y14
6	1 5/16 - 1 7/16	IC 1/2"	4IR6W	NVR20-4	-
	1 1/2 - 1 5/8	IC 1/2"	4IR6W	AVR25-4	Y14-1P
	1 7/8 - 1.9	IC 1/2"	4IR6W	AVR32-4	Y14
	2.1 - 3.1	IC 1/2"	4IR6W	AVR40-4	Y14
	3 1/4 - 7	IC 1/2"	4IR6W	AVR40-4	Y14 - 1N
5	1 3/4	IC 1/2"	4IR5W	AVR25-4	Y14-1P
	3 - 3 1/4	IC 1/2"	4IR5W	AVR40-4	Y14
4.5	2	IC 5/8"	5IR4.5W	AVR32-5	Y15 - 1P
	3 1/2 - 4	IC 5/8"	5IR4.5W	AVR60-5	Y15
4	2 1/4	IC 5/8"	5IR4W	AVR40-5	Y15 - 1P
	2 1/2	IC 5/8"	5IR4W	AVR40-5	Y15
	4 1/4 - 4 3/4	IC 5/8"	5IR4W	AVR60-5	Y15
	4 7/8 - 7	IC 5/8"	5IR4W	AVR60-5	Y15 - 1N
3.5	2 3/4	IC 5/8" U	5UEI3.5W	AVR40-5U	Y15U - 1P
	3	IC 5/8" U	5UEI3.5W	AVR50-5U	Y15U
3.25	3 1/4	IC 5/8" U	5UEI3.25W	AVR50-5U	Y15U
	3 1/2	IC 5/8" U	5UEI3.25W	AVR60-5U	Y15U
3	3 3/4 - 4	IC 5/8" U	5UEI3W	AVR60-5U	Y15U
2.75	5	IC 5/8" U	5UEI2.75W	AVR60-5U	Y15U
2.5	6	IC 5/8" V	5VIR2.5W	NVR60-5V	-

Werkzeugempfehlung für das Innengewindedrehen

Downloads von TT Gen
und Updates
unter www.vargus.de



BSP(G) 55° zylindrisches Rohrgewinde

Teilung G/Z	Gewinde	Plattengrösse	Bestellnummer		
			Wendeplatte	Halter	Unterlegplatte
28	G1/16	Micro 6.0	6.0SIR28W	SMC..-6.0	-
	G1/8	IC 5.0 L	5LIR28W	.NVR10.-5L	-
19	G1/4	IC 6.0	6.0IR19W	.NVR1..-6.0	-
	G3/8	IC 1/4"	2IR19W	NVR10-2	-
14	G1/2 & G5/8	IC 3/8"	3IR14W	NVR13-3	-
	G3/4 & G7/8	IC 3/8"	3IR14W	AVR20-3	YI3
11	G1 & G1 1/8 & 1 1/4	IC 3/8"	3IR11W	AVR25-3	YI3
	G1 1/2	IC 3/8"	3IR11W	AVR40-3	YI3 - 1N
	G1 3/4	IC 3/8"	3IR11W	AVR40-3	YI3 - 1N
	G2	IC 3/8"	3IR11W	AVR40-3	YI3 - 1N
	G2 1/4	IC 3/8"	3IR11W	AVR40-3	YI3 - 1N
	G2 1/2	IC 3/8"	3IR11W	AVR40-3	YI3 - 1N
	G2 3/4	IC 3/8"	3IR11W	AVR40-3	YI3 - 1N
	G3	IC 3/8"	3IR11W	AVR40-3	YI3 - 1N
	G3 1/2	IC 3/8"	3IR11W	AVR40-3	YI3 - 1N
	G4	IC 3/8"	3IR11W	AVR40-3	YI3 - 1N
	G4 1/2	IC 3/8"	3IR11W	AVR40-3	YI3 - 1N
	G5	IC 3/8"	3IR11W	AVR40-3	YI3 - 1N
	G5 1/2	IC 3/8"	3IR11W	AVR40-3	YI3 - 1N
	G6	IC 3/8"	3IR11W	AVR40-3	YI3 - 1N

BSPT

Teilung G/Z	Gewinde	Plattengrösse	Bestellnummer		
			Wendeplatte	Halter	Unterlegplatte
28	1/8	IC 5.0 L	5LIR28BSPT	.NVR1..-5L	-
19	1/4	IC 6.0	6.0IR19BSPT	.NVR1..-6.0	-
	3/8	IC 1/4"	2IR19BSPT	NVR10-2	-
14	1/2	IC 3/8"	3IR14BSPT	NVR13-3	-
	3/4	IC 3/8"	3IR14BSPT	AVR20-3	YI3
11	1	IC 3/8"	3IR11BSPT	AVR25-3	YI3
	1 1/4	IC 3/8"	3IR11BSPT	AVR32-3	YI3
	1 1/2	IC 3/8"	3IR11BSPT	AVR40-3	YI3 - 1N
	2	IC 3/8"	3IR11BSPT	AVR40-3	YI3 - 1N
	2 1/2	IC 3/8"	3IR11BSPT	AVR40-3	YI3 - 1N
	3	IC 3/8"	3IR11BSPT	AVR40-3	YI3 - 1N
	4	IC 3/8"	3IR11BSPT	AVR40-3	YI3 - 1N
	5	IC 3/8"	3IR11BSPT	AVR40-3	YI3 - 1N
	6	IC 3/8"	3IR11BSPT	AVR40-3	YI3 - 1N

Werkzeugempfehlung für das Innengewindedrehen

Downloads von TT Gen
und Updates
unter www.vargus.de



NPT

Teilung G/Z	Gewinde	Plattengröße	Bestellnummer		
			Wendeplatte	Halter	Unterlegplatte
27	1/16	Micro 6.0	6.0SIR27NPT	SMC...-6.0	-
18	1/4	Micro 6.0	6.0SIR18NPT	SMC...-6.0	-
	3/8	Micro 6.0	6.0SIR18NPT	SMC...-6.0	-
14	1/2	IC 3/8"	3IR14NPT	NVR13-3	-
	3/4	IC 3/8"	3IR14NPT	NVR13-3	-
11.5	1	IC 3/8"	3IR11.5NPT	AVR20-3	Y13
	1 1/4	IC 3/8"	3IR11.5NPT	AVR32-3	Y13
	1 1/2	IC 3/8"	3IR11.5NPT	AVR32-3	Y13 - 1N
	2	IC 3/8"	3IR11.5NPT	AVR40-3	Y13 - 1N
8	2 1/2	IC 3/8"	3IR8NPT	AVR40-3	Y13 - 1N
	3	IC 3/8"	3IR8NPT	AVR40-3	Y13 - 1N
	3 1/2	IC 3/8"	3IR8NPT	AVR40-3	Y13 - 1N
	4	IC 3/8"	3IR8NPT	AVR40-3	Y13 - 1N
	5	IC 3/8"	3IR8NPT	AVR40-3	Y13 - 1N
	6	IC 3/8"	3IR8NPT	AVR40-3	Y13 - 1N
	8	IC 3/8"	3IR8NPT	AVR40-3	Y13 - 1N
	10	IC 3/8"	3IR8NPT	AVR40-3	Y13 - 1N
	12	IC 3/8"	3IR8NPT	AVR40-3	Y13 - 1N

NPTF

Teilung G/Z	Gewinde	Plattengröße	Bestellnummer		
			Wendeplatte	Halter	Unterlegplatte
27	1/8	IC 5.0 L	5LIR27NPTF	.NVR1...-5L	-
18	1/4	IC 6.0	6.0IR18NPTF	.NVR1...-6.0	-
	3/8	IC 1/4"	2IR18NPTF	NVR10-2	-
14	1/2	IC 3/8"	3IR14NPTF	NVR13-3	-
	3/4	IC 3/8"	3IR14NPTF	NVR16-3	-
11.5	1	IC 3/8"	3IR11.5NPTF	AVR20-3	Y13
	1 1/4	IC 3/8"	3IR11.5NPTF	AVR32-3	Y13
	1 1/2	IC 3/8"	3IR11.5NPTF	AVR32-3	Y13 - 1N
	2	IC 3/8"	3IR11.5NPTF	AVR40-3	Y13 - 1N
8	2 1/2	IC 3/8"	3IR8NPTF	AVR40-3	Y13 - 1N
	3	IC 3/8"	3IR8NPTF	AVR40-3	Y13 - 1N

PG

Teilung G/Z	Gewinde	Plattengröße	Bestellnummer		
			Wendeplatte	Halter	Unterlegplatte
20	Pg 7	IC 6.0	6.0IR20PG	.NVR 1..6.0	-
	Pg 9	IC 1/4"	2IR18PG	NVR10-2	-
18	Pg 11 & Pg 13.5	IC 3/8"	3IR18PG	NVR13-3	-
	Pg 16	IC 3/8"	3IR18PG	NVR16-3	-
16	Pg 21	IC 3/8"	3IR16PG	AVR20-3	Y13
	Pg 29	IC 3/8"	3IR16PG	AVR25-3	Y13 - 1N
	Pg 36 & Pg 42 & Pg 48	IC 3/8"	3IR16PG	AVR40-3	Y13 - 1N



Gewindedrehen



GEWINDEDREHPLATTEN

■ Vardex Bestellnummernsystem	Seite 18
■ Teilprofil 60°	Seite 20
■ Teilprofil 55°	Seite 23
■ ISO metrisch	Seite 26
■ American UN	Seite 35
■ Whitworth für BSW, BSP(G)	Seite 45
■ BSPT	Seite 53
■ NPT	Seite 56
■ NPTF	Seite 61
■ NPS	Seite 64
■ Rund (DIN 405)	Seite 65
■ Rund (DIN 20400)	Seite 66
■ Trapez	Seite 67
■ American ACME	Seite 70
■ Stub ACME	Seite 73
■ UNJ	Seite 76
■ MJ	Seite 81
■ American Buttress	Seite 83
■ British Buttress	Seite 85
■ Metrisch Säge	Seite 86
■ API	Seite 87
■ API Buttress Casing	Seite 88
■ API Round Casing & Tubing	Seite 89
■ VAM	Seite 91
■ EL-Extreme Line	Seite 92
■ Hughes H-90	Seite 93
■ Pg	Seite 94

microscope Bestellnummernsystem für Schneideinsätze

Micro Einsätze Gewindedrehplatten - Einseitig

M	5	42	TH	0.5	ISO	L16	R	VBX																												
1	2	3	4	5	6	7	8	9																												
1 - Produktlinie		2 - Plattengröße		3 - Mindestbohrungsdurchmesser																																
M - Microscope		4, 5, 6, 7		3,2, 4,2,...																																
4 - Anwendung			5 - Teilung (für Gewindedrehen)			6 - Gewindenorm																														
TH - Gewindedrehen			<table border="1"> <thead> <tr> <th colspan="4">Vollprofil - Teilungsbereich</th> </tr> <tr> <th colspan="2">mm</th> <th colspan="2">G/Z</th> </tr> </thead> <tbody> <tr> <td colspan="2">0,5-1,5</td> <td colspan="2">28-18</td> </tr> <tr> <th colspan="4">Teilprofil - Teilungsbereich</th> </tr> <tr> <th colspan="2">mm</th> <th colspan="2">G/Z</th> </tr> <tr> <td>A</td> <td>0,5 - 1,5</td> <td>A</td> <td>48 - 16</td> </tr> <tr> <td>F</td> <td>0,5 - 1,0</td> <td>F</td> <td>48 - 24</td> </tr> </tbody> </table>			Vollprofil - Teilungsbereich				mm		G/Z		0,5-1,5		28-18		Teilprofil - Teilungsbereich				mm		G/Z		A	0,5 - 1,5	A	48 - 16	F	0,5 - 1,0	F	48 - 24	ISO - ISO Metrisch UN - American UN W - Whitworth für BSW, BSP NPT - NPT 60° - Teilprofil 60° 55° - Teilprofil 55°		
Vollprofil - Teilungsbereich																																				
mm		G/Z																																		
0,5-1,5		28-18																																		
Teilprofil - Teilungsbereich																																				
mm		G/Z																																		
A	0,5 - 1,5	A	48 - 16																																	
F	0,5 - 1,0	F	48 - 24																																	
7 - Auskrümmung			8 - LH oder RH			9 - Hartmetallsorten																														
In mm			R - RH L - LH			VBX																														

Vardex Bestellnummernsystem

Gewindedrehplatten (ohne Micro und Microscope Systemen)

3		E	R	1.5	ISO					VTX	
1	2	3	4	5	6	7	8	9	10	11	12

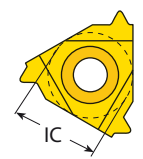
1 - Plattengröße
5L - IC5,0L mm 4.0K - IC4,0 mm 6.0 - IC6,0 mm 2 - IC1/4" 3 - IC 3/8" 4 - IC 1/2" 5 - IC5/8"

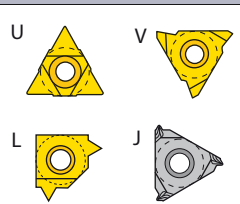
2 - Plattentyp

3 - Platte
E - Aussen I - Innen EI - Aussen +Innen

4 - RH/LH Platte
R - Rechte Platte L - Linke Platte leer... - Rechte + Linke WSP

5 - Teilung		
Vollprofil - Teilungsbereich		
mm	G/Z	
0,35-12,0	72-2	
Teilprofil - Teilungsbereich		
mm	G/Z	
A	0,5 - 1,5	48 - 16
AG	0,5 - 3,0	48 - 8
G	1,75 - 3,0	14 - 8
N	3,5 - 5,0	7 - 5
U	5,5 - 8,0	4½ - 3½
Q	5,5 - 6,0	4½ - 4
U	6,5 - 9,0	4 - 2¾
V	6,0 - 10,0	4 - 2½

6 - Norm	
60° - Teilprofil 60° 55° - Teilprofil 55° ISO - ISO Metrisch UN - American UN W - Whitworth für BS, BSP BSPT - Rohrgewinde konisch NPT - NPT NPTF - NPTF NPS - NPS RD - Rund DIN 405 RD20400 - Rund DIN 20400 TR - Trapez DIN 103 ACME - ACME	STACME - Stub ACME UNJ - UNJ MJ - ISO 5855 ABUT - Amerikanisches Sägegewinde BBUT - Britisches Sägegewinde SAGE - Metr. Sägegewinde DIN 513 API - API BUT - API Buttress Casing APPIRD - API Round Casing & Tubing VAM - VAM EL - Extreme Line Casing H90 - H90 PG - Pg DIN 40430

7 - Anzahl der Zähne
6C - V6 Schneidkanten leer... - All Others

8 - API Form
382 2 383 3 403 15 502 75 503 125

9 - Anzahl der Zähne
(für Mehrzahn-WSP) 2, 3, 5, 6, 8

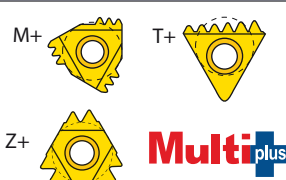
10 - Mehrzahnform

11 - Hartmetallsorte
VKX, VTX, VCB, VM7, VK2, VK2P, VKP, VHx, VBx

12 - Platten für Regelgewinde
158/...

Micro Einsätze Gewindedrehplatten - Zweiseitig

3	S	I	R	0.5	ISO	VMX
1	2	3	4	5	6	7

1 - Einsatzdurchmesser
3.0 - 3.0 mm 4.0 - 4.0 mm 6.0 - 6.0 mm 8.0 - 8.0 mm 10.0 - 10.0 mm

2 - Plattentyp
S - Micro Einsatz

3 - Platte
I - Innen

4 - RH/LH Platte
R - Rechte Schneideinsatz R - Linker Schneideinsatz

5 - Teilung			
Vollprofil - Teilungsbereich			
mm	G/Z		
0,30-1,5	40-16		
Teilprofil - Teilungsbereich			
mm	G/Z		
A	0,5 - 1,5	A	48 - 16
F	0,5 - 3,0	F	48 - 24

6 - Norm
60° - Teilprofil 60° 55° - Teilprofil 55° ISO - ISO Metrisch MJ - ISO 5855 NPT - NPT NPTF - NPTF UN - American UN W - Whitworth für BS, BSP

7 - Hartmetallsorten
VMX

Teilprofil 60°

Aussen

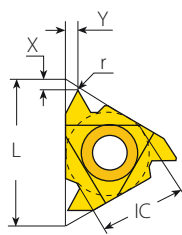
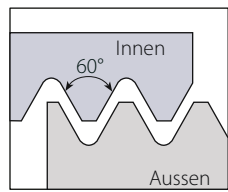

Standard

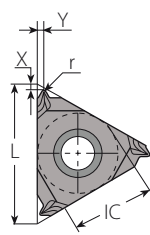

SCB
Gesinterter
Spanbrecher

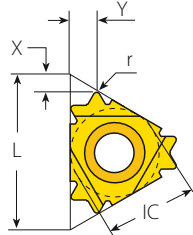

V6

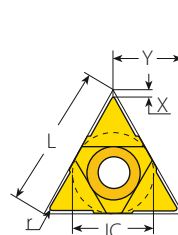

U Typ

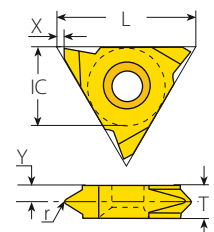

V Typ / Silm Throat

Standard



Plattengrösse		Teilung		Bestellnummer		Abmessungen mm			Unterlegplatte		
IC	L mm	mm	G/Z	RH	LH	r	X	Y	RH	LH	Klemmhalter
1/4"	11	0.5-1.5	48-16	2ERA60...	2ELA60...	0.05	0.8	0.9	-	-	NL...-2 (LH)
		0.5-1.5	48-16	2ERA60...	3ELA60...	0.05	0.8	0.9			
3/8"	16	1.75-3.0	14-8	2ERA60...	3ELG60...	0.27	1.2	1.7	YE3	YI3	AL...-3 (LH)
		0.5-3.0	48-8	3ERAG60...	3ELAG60...	0.08	1.2	1.7			
3/8" SCB	16	0.5-1.5	48-16	3JERA60...		0.05	0.6	0.8			
		1.75-3.0	14-8	3JERG60...		0.27	1.1	1.5	YE3	-	AL...-3
		0.5-3.0	48-8	3JERAG60...		0.08	0.9	1.5			
3/8" V6	16	0.5-2.0	48-13	3ERS60-6C...		0.06	1.9	3.0	YE3-6C	-	AL...-3
1/2"	22	3.5-5.0	7-5	4ERN60...	4ELN60...	0.53	1.7	2.5	YE4	YI4	AL...-4 (LH)
5/8"	27	5.5-6.0	4.5-4	5ERQ60...	5ELQ60...	0.64	2.1	3.1	YE5	YI5	AL...-5 (LH)

U Typ



Plattengrösse		Teilung		Bestellnummer		Abmessungen mm			Unterlegplatte		
IC	L mm	mm	G/Z	RH+LH		r	X	Y	RH	LH	Klemmhalter
1/2"U	22	5.5-8.0	4.5-3.25	4UEIU60...		0.30	0.6	11.0	YE4U	YI4U	AL...-4U (LH)
5/8"U	27	6.5-9.0	4-2.75	5UEIU60...		0.37	1.0	13.7	YE5U	YI5U	AL...-5U (LH)

Slim Throat



Plattengrösse		Teilung		Bestellnummer		Abmessungen mm				
IC	L mm	mm	G/Z	RH	LH	r	X	Y	T	Klemmhalter
1/4"V	11	0.5-1.5	48-16	2VERA60...	2VELA60...	0.05	0.69	2.3	3.2	NL...-2V (LH)
		0.5-1.5	48-16	3VERA60...	3VELA60...	0.05	1.10	2.7	3.6	
3/8"V	16	1.75-3.0	14-8	3VERG60...	3VELG60...	0.27	1.10	1.9	3.6	NL...-3V (LH)
		0.5-3.0	48-8	3VERAG60...	3VELAG60...	0.08	1.10	1.9	3.6	
1/2"V	22	3.5-5.0	7-5	4VERN60...	4VELN60...	0.53	1.10	2.3	4.8	NL...-4V (LH)

V Typ



Plattengrösse		Teilung		Bestellnummer		Abmessungen mm				
IC	L mm	mm	G/Z	RH	LH	r	X	Y	T	Klemmhalter
5/8"V	27	6.0-10.0	4-2.5	5VERV60...	5VERV60...	0.75	0.6	5.2	10	NL...-5V-10 (LH)

Teilprofil 60° (Fortsetzung)

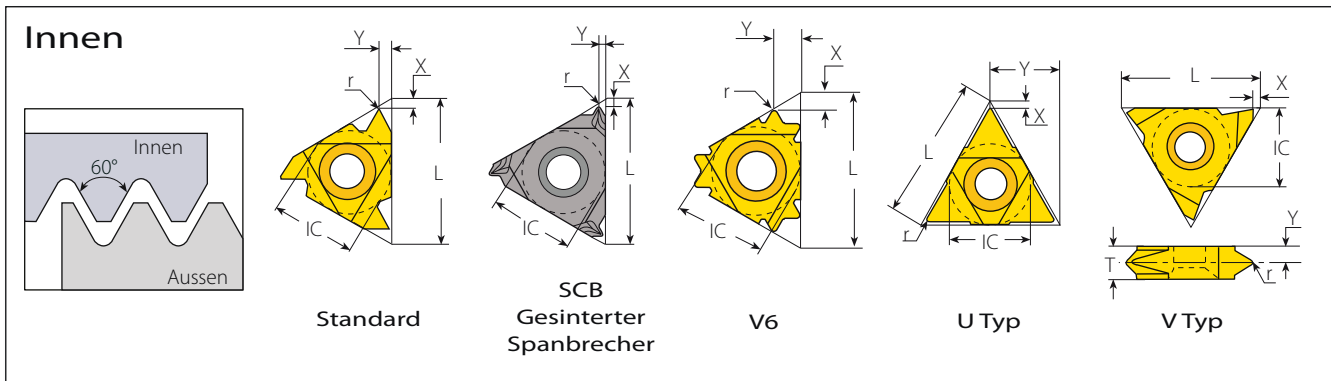

Standard



Plattengröße	Teilung			Bestellnummer		Abmessungen mm			Unterlegplatte			
	IC	L mm	mm	G/Z	RH	LH	r	X	Y	RH	LH	Klemmhalter
1/4"	11		0.5-1.5	48-16	2IRA60...	2ILA60...	0.05	0.8	0.9	-	-	NVR..-2 (LH)
1/4" SCB	11		0.5-1.5	48-16	2JIRA60...		0.05	0.6	0.8	-	-	NVR..-2
3/8"	16		0.5-1.5	48-16	3IRA60...	3ILA60...	0.05	0.8	0.9	YI3	YE3	AVR..-3 (LH)
			1.75-3.0	14-8	3IRG60...	3ILG60...	0.16	1.2	1.7			
			0.5-3.0	48-8	3IRAG60...	3ILAG60...	0.05	1.2	1.7			
3/8" SCB	16		0.5-1.5	48-16	3JIRA60...		0.05	0.6	0.8	YI3	-	AVR..-3
			1.75-3.0	14-8	3JIRG60...		0.16	1.0	1.5			
			0.5-3.0	48-8	3JIRAG60...		0.05	0.9	1.5			
3/8" V6	16		0.5-2.0	48-14	3IRS60-6C...		0.03	1.6	2.6	YI3-6C	-	AVR..-3 NVRC...-3 206/..
1/2"	22		3.5-5.0	7-5	4IRN60...	4ILN60...	0.30	1.7	2.5	YI4	YE4	AVR..-4 (LH)
5/8"	27		5.5-6.0	4.5-4	5IRQ60...	5ELQ60...	0.30	1.8	2.7	YI5	YE5	AVR..-5 (LH)

U Typ



Plattengröße	Teilung			Bestellnummer		Abmessungen mm			Unterlegplatte			
	IC	L mm	mm	G/Z	RH+LH	r	X	Y	RH	LH	Klemmhalter	
1/2"U	22		5.5-8.0	4.5-3.25	4UEIU60...		0.30	0.6	11.0	YI4U	YE4U	AVR..-4U (LH)
5/8"U	27		6.5-9.0	4-2.75	5UEIU60...		0.37	1.0	13.7	YI5U	YE5U	AVR..-5U (LH)

V Typ



Plattengröße	Teilung			Bestellnummer		Abmessungen mm					
	IC	L mm	mm	G/Z	RH	LH	r	X	Y	T	Klemmhalter
5/8"V	27		6.0-10.0	4-2.5	5VIRV60...	5VILV60...	0.35	1.0	4.3	8	NVR..-5V (LH)

Teilprofil 60° (Fortsetzung)



Innen

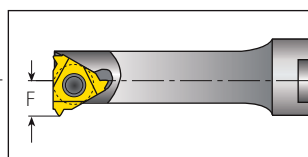
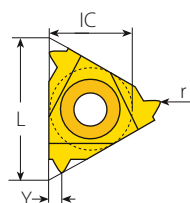
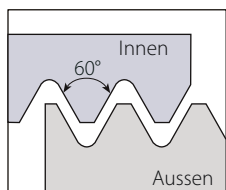

Mini-3 - Gewinde

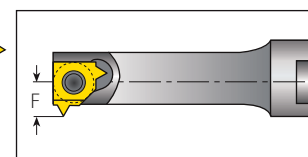
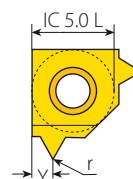

Mini-L - Gewinde

Mini-3 - Gewinde



Plattengröße		Teilung		Bestellnummer	Abmessungen mm			Min. Bohrungsdurchmesser	Klemmhalter
IC	L mm	mm	G/Z	RH	r	Y	F	mm	
4.0	6	0.5-1.25	48-20	4.0KIRA60...	0.05	0.6	3.7	6.35	.NVR.5-4.0K
6.0	10	0.5-1.5	48-16	6.0IRA60...	0.05	0.9	5.3	10.00	.NVR 1.-6.0

Mini-L - Gewinde



Plattengröße		Teilung		Bestellnummer	Abmessungen mm			Min. Bohrungsdurchmesser	Klemmhalter
IC	mm	G/Z	RH	r	Y	F	mm		
5.0L	0.5-1.5	48-16	5LIRA60...	0.05	0.9	4.65	8.0	.NVR 10.-5L	

Innen

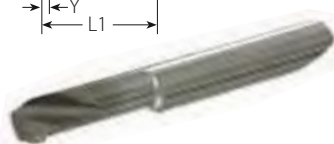
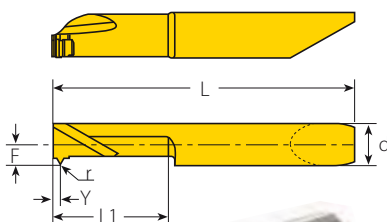
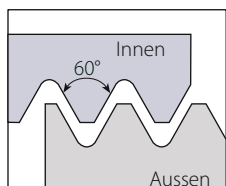

RH - Einseitig

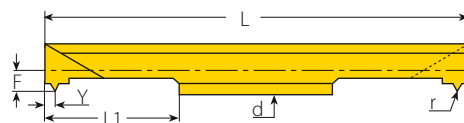

RH - Zweiseitig

Micro - Zweiseitig

Einsatzdurchmesser		Teilung		Bestellnummer	Abmessungen mm					Min. Bohrungsdurchmesser	Klemmhalter
d mm	mm	G/Z	RH/LH	r	L1	L	F	Y	mm		
3.0	0.5-1.0	48-24	3.0SIRF60...	0.05	16	50	1.46	0.9	3.3	SMC...-3.0	
4.0	0.5-1.0	48-24	4.0SIRF60...	0.05	16	50	1.96	0.9	4.3	SMC...-4.0	
6.0	0.5-1.5	48-16	6.0SIRA60...	0.05	16	50	2.50	0.9	6.0	SMC...-6.0	

LH Werkzeug lieferbar auf Anfrage. (Beispiel: 6.0SILA60...)

Micro - Einseitig



Einsatzdurchmesser		Teilung		Bestellnummer	Abmessungen mm						Min. Bohrungsdurchmesser	Klemmhalter
d mm	mm	G/Z	RH/LH	r	L1	L	F	Y	h (max)	mm		
4.0	0.5-1.0	48-24	M429THF60L16R/L	0.05	16	33	0.9	0.9	0.65	3.2	MHC...-4	
4.0	0.5-1.0	48-24	M439THF60L16R/L	0.05	16	33	1.9	0.9	0.76	4.2	MHC...-4	
6.0	0.5-1.5	48-16	M659THA60L16R/L	0.05	16	42	2.9	0.9	1.49	6.2	MHC...-6	

LH Werkzeug lieferbar auf Anfrage. (Beispiel: M429THF60L16L)

Teilprofil 55°

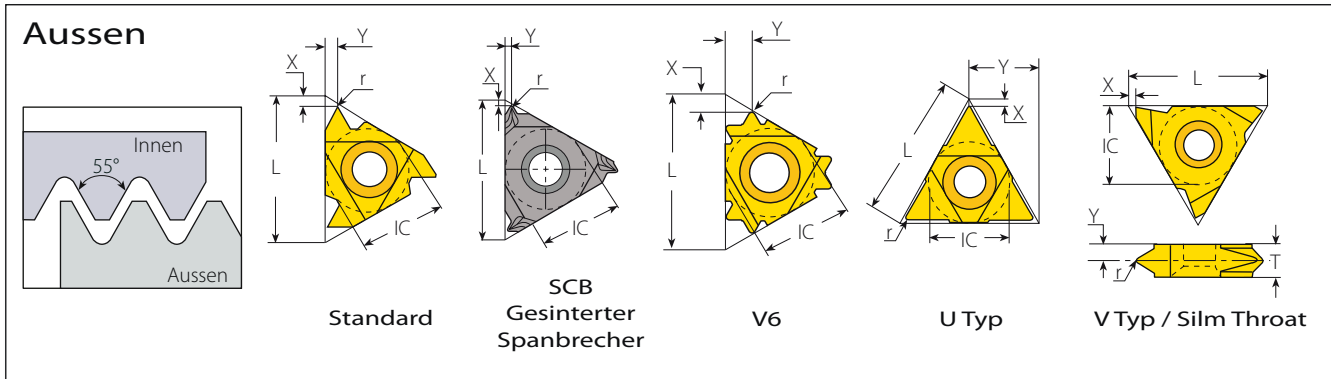

Standard



Plattengrösse	Teilung		Bestellnummer		Abmessungen mm			Unterlegplatte			
	IC	L mm	mm	G/Z	RH	LH	r	X	Y	RH	LH
1/4"	11	0.5-1.5	48-16	2ERA55...	2ELA55...	0.05	0.8	0.9	-	-	NL...-2 (LH)
		0.5-1.5	48-16	3ERA55...	3ELA55...	0.05	0.8	0.9	-	-	-
3/8"	16	1.75-3.0	14-8	3ERG55...	3ELG55...	0.21	1.2	1.7	YE3	YI3	AL...-3 (LH)
		0.5-3.0	48-8	3ERAG55...	3ELAG55...	0.07	1.2	1.7	-	-	-
3/8" SCB	16	0.5-1.5	48-16	3JERA55...	-	0.05	0.6	0.8	-	-	-
		1.75-3.0	14-8	3JERG55...	-	0.21	1.1	1.5	YE3	-	AL...-3
		0.5-3.0	48-8	3JERAG55...	-	0.07	0.9	1.5	-	-	-
3/8" V6	16	-	48-14	3ERS55-6C...	-	0.05	1.8	2.8	YE3-6C	-	AL...-3
1/2"	22	3.5-5.0	7-5	4ERN55...	4ELN55...	0.43	1.7	2.5	YE4	YI4	AL...-4 (LH)
5/8"	27	5.5-6.0	4,5-4	5ERQ55...	5ELQ55...	0.60	2.0	2.9	YE5	YI5	AL...-5 (LH)

U Typ



Plattengrösse	Teilung		Bestellnummer		Abmessungen mm			Unterlegplatte		
	IC	L mm	mm	G/Z	RH+LH	r	X	Y	RH	LH
1/2"U	22	5.5-8.0	4.5-3.25	4UEIU55...	0.60	0.9	11.0	YE4U	YI4U	AL...-4U (LH)
5/8"U	27	6.5-9.0	4-2.75	5UEIU55...	0.80	1.2	13.7	YE5U	YI5U	AL...-5U (LH)

Slim Throat



Plattengrösse	Teilung		Bestellnummer		Abmessungen mm				Klemmhalter	
	IC	L mm	mm	G/Z	RH	LH	r	X		Y
1/4"V	11	0.5-1.5	48-16	2VERA55...	2VELA55...	0.05	0.8	2.7	3.2	NL...-2V (LH)
		0.5-1.5	48-16	3VERA55...	3VELA55...	0.05	1.1	2.7	3.6	-
3/8"V	16	1.75-3.0	14-8	3VERG55...	3VELG55...	0.21	1.1	1.9	3.6	NL...-3V (LH)
		0.5-3.0	48-8	3VERAG55...	3VELAG55...	0.07	1.1	1.9	3.6	-
1/2"V	22	3.5-5.0	7-5	4VERN55...	4VELN55...	0.43	1.1	2.3	4.8	NL...-4V (LH)

V Typ



Plattengrösse	Teilung		Bestellnummer		Abmessungen mm				Klemmhalter	
	IC	L mm	mm	G/Z	RH	LH	r	X		Y
5/8"V	27	6.0-9.0	4-2.75	5VERV55...	5VELV55...	0.70	1.0	4.3	8	NL...-5V-8 (LH)

Teilprofil 55° (Fortsetzung)

Innen

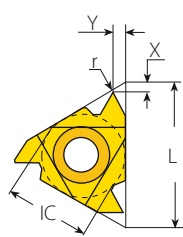
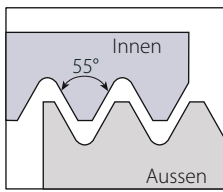

Standard

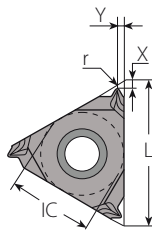

SCB
Gesinterter
Spanbrecher

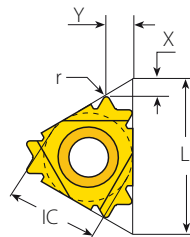

V6

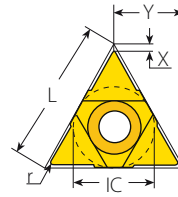

U Typ

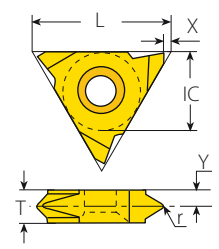

V Typ

Standard



Plattengrösse		Teilung		Bestellnummer		Abmessungen mm			Unterlegplatte		
IC	L mm	mm	G/Z	RH	LH	r	X	Y	RH	LH	Klemmhalter
1/4"	11	0.5-1.5	48-16	2IRA55...	2ILA55...	0.05	0.8	0.9	-	-	NVR..-2 (LH)
1/4" SCB	11	0.5-1.5	48-16	2JIRA55...		0.05	0.6	0.8	-	-	NVR..-2
3/8"	16	0.5-1.5	48-16	3IRA55...	3ILA55...	0.05	0.8	0.9	YI3	YE3	AVR..-3 (LH)
		1.75-3.0	14-8	3IRG55...	3ILG55...	0.21	1.2	1.7			
		0.5-3.0	48-8	3IRAG55...	3ILAG55...	0.07	1.2	1.7			
3/8" SCB	16	0.5-1.5	48-16	3JIRA55...		0.05	0.6	0.8	YI3	-	AVR..-3
		1.75-3.0	14-8	3JIRG55...		0.21	1.1	1.5			
		0.5-3.0	48-8	3JIRAG55...		0.07	0.9	1.5			
3/8" V6	16	-	48-16	3IRS55-6C...		0.05	1.6	2.6	YI3-6C	-	AVR..-3 NVRC..-3 206/...
1/2"	22	3.5-5.0	7-5	4IRN55...	4ILN55...	0.43	1.7	2.5	YI4	YE4	AVR..-4 (LH)
5/8"	27	5.5-6.0	4.5-4	5IRQ55...	5ILQ55...	0.60	2.0	2.9	YI5	YE5	AVR..-5 (LH)

U Typ



Plattengrösse		Teilung		Bestellnummer		Abmessungen mm			Unterlegplatte		
IC	L mm	mm	G/Z	RH+LH		r	X	Y	RH	LH	Klemmhalter
1/2"U	22	5.5-8.0	4.5-3.25	4UEIU55...		0.60	0.9	11.0	YI4U	YE4U	AVR..-4U (LH)
5/8"U	27	6.5-9.0	4-2.75	5UEIU55...		0.80	1.2	13.7	YI5U	YE5U	AVR..-5U (LH)

V Typ



Plattengrösse		Teilung		Bestellnummer		Abmessungen mm				
IC	L mm	mm	G/Z	RH	LH	r	X	Y	T	Klemmhalter
5/8"V	27	6.0-9.0	4-2.75	5VIRV55...	5VILV55...	0.70	1.0	4.3	8	NVR..-5V (LH)

Teilprofil 55° (Fortsetzung)



Innen

Mini3-Gewinde **Mini-L-Gewinde**

Mini-3 - Gewinde



Plattengröße		Teilung		Bestellnummer	Abmessungen mm				Min. Bohrungsdurchmesser	Klemmhalter
IC	L mm	mm	G/Z	RH	r	Y	F	mm		
4.0	6	0.5-1.25	48-20	4.0KIRA55...	0.05	0.6	3.8	6.45	.NVR.5-4.0K	
6.0	10	0.5-1.50	48-16	6.0IRA55...	0.05	0.9	5.3	10.00	.NVR 1.-6.0	

Mini-L - Gewinde



Plattengröße		Teilung		Bestellnummer	Abmessungen mm				Min. Bohrungsdurchmesser	Klemmhalter
IC	mm	G/Z	RH	r	Y	F	mm			
5.0L	0.5-1.5	48-16	5LIRA55...	0.05	0.9	4.65	8.0	.NVR 10.-5L		

Teilprofil 55°

Innen

RH - Einseitig **RH - Zweiseitig**

Micro - Zweiseitig

Einsatzdurchmesser		Teilung		Bestellnummer	Abmessungen mm					Min. Bohrungsdurchmesser	Klemmhalter
d mm	mm	G/Z	RH/LH	r	L1	L	F	Y	mm		
3.0	0.5-1.0	48-24	3.0SIRF55...	0.05	16	50	1.46	0.9	3.3	SMC..-3.0	
4.0	0.5-1.0	48-24	4.0SIRF55...	0.05	16	50	1.96	0.9	4.3	SMC..-4.0	
6.0	0.5-1.5	48-16	6.0SIRA55...	0.05	16	50	2.50	0.9	6.0	SMC..-6.0	

LH Werkzeug lieferbar auf Anfrage. (Beispiel: 6.0SILA55...)

Micro - Einseitig



Einsatzdurchmesser		Teilung		Bestellnummer	Abmessungen mm						Min. Bohrungsdurchmesser	Klemmhalter
d mm	mm	G/Z	RH/LH	r	L1	L	F	Y	h(max)	mm		
4.0	0.5-1.0	48-24	M429TH F55 L16R/L	0.05	16	33	0.9	0.75	0.76	3.2	MHC ..-4	
4.0	0.5-1.0	48-24	M439TH F55 L16R/L	0.05	16	33	1.9	0.75	0.76	4.2	MHC ..-4	
6.0	0.5-1.5	48-16	M659TH A55 L16R/L	0.05	16	42	2.9	0.9	1.49	6.2	MHC ..-6	

LH Werkzeug lieferbar auf Anfrage. (Beispiel: M429TH F55 L16L)

ISO metrisch

Aussen

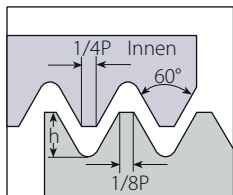

Norm: R262 (DIN 13)
Toleranzklasse: 6g/6H

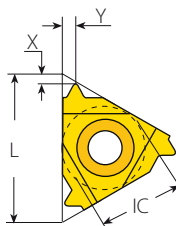

Standard

Standard

Plattengrösse		Teilung	Bestellnummer		Abmessungen mm			Unterlegplatte		Klemmhalter
IC	L mm	mm	RH	LH	h min	X	Y	RH	LH	
1/4"	11	0.25	2ER0.25ISO...	2EL0.25ISO...	0.14	0.4	0.2	-	-	NL..-2 (LH)
		0.3	2ER0.3ISO...	2EL0.3ISO...	0.19	0.7	0.3			
		0.35	2ER0.35ISO...	2EL0.35ISO...	0.21	0.8	0.4			
		0.4	2ER0.4ISO...	2EL0.4ISO...	0.25	0.7	0.4			
		0.45	2ER0.45ISO...	2EL0.45ISO...	0.28	0.7	0.4			
		0.5	2ER0.5ISO...	2EL0.5ISO...	0.31	0.6	0.4			
		0.6	2ER0.6ISO...	2EL0.6ISO...	0.37	0.6	0.6			
		0.7	2ER0.7ISO...	2EL0.7ISO...	0.43	0.6	0.6			
		0.75	2ER0.75ISO...	2EL0.75ISO...	0.46	0.6	0.6			
		0.8	2ER0.8ISO...	2EL0.8ISO...	0.49	0.6	0.6			
		1.0	2ER1.0ISO...	2EL1.0ISO...	0.61	0.7	0.7			
		1.25	2ER1.25ISO...	2EL1.25ISO...	0.77	0.8	0.9			
		1.5	2ER1.5ISO...	2EL1.5ISO...	0.92	0.8	1.0			
		1.75	2ER1.75ISO...	2EL1.75ISO...	1.07	0.8	1.1			
3/8"	16	0.25	3ER0.25ISO...	3EL0.25ISO...	0.14	0.4	0.2	YE3	YI3	AL..-3 (LH)
		0.35	3ER0.35ISO...	3EL0.35ISO...	0.21	0.8	0.4			
		0.4	3ER0.4ISO...	3EL0.4ISO...	0.25	0.7	0.4			
		0.45	3ER0.45ISO...	3EL0.45ISO...	0.28	0.7	0.4			
		0.5	3ER0.5ISO...	3EL0.5ISO...	0.31	0.6	0.4			
		0.6	3ER0.6ISO...	3EL0.6ISO...	0.37	0.6	0.6			
		0.7	3ER0.7ISO...	3EL0.7ISO...	0.43	0.6	0.6			
		0.75	3ER0.75ISO...	3EL0.75ISO...	0.46	0.6	0.6			
		0.8	3ER0.8ISO...	3EL0.8ISO...	0.49	0.6	0.6			
		1.0	3ER1.0ISO...	3EL1.0ISO...	0.61	0.7	0.7			
		1.25	3ER1.25ISO...	3EL1.25ISO...	0.77	0.8	0.9			
		1.5	3ER1.5ISO...	3EL1.5ISO...	0.92	0.8	1.0			
		1.75	3ER1.75ISO...	3EL1.75ISO...	1.07	0.9	1.2			
		2.0	3ER2.0ISO...	3EL2.0ISO...	1.23	1.0	1.3			
		2.5	3ER2.5ISO...	3EL2.5ISO...	1.53	1.1	1.5			
		3.0	3ER3.0ISO...	3EL3.0ISO...	1.84	1.2	1.6			
3.5	3ER3.5ISO...	3EL3.5ISO...	2.15	1.6	1.9					



Weiter Nächste Seite ▶

ISO metrisch (Fortsetzung)

Aussen

Norm: R262 (DIN 13)
Toleranzklasse: 6g/6H



SCB
Gesinterter Spanbrecher

V6

Standard

U Typ

Standard

Plattengrösse		Teilung	Bestellnummer		Abmessungen mm			Unterlegplatte			
IC	L mm	mm	RH	LH	h min	X	Y	RH	LH	Klemmhalter	
	3/8" SCB	16	0.5	3JER0.5ISO...		0.31	1.2	0.5	YE3	-	AL..-3
			0.75	3JER0.75ISO...		0.46	1.2	0.5			
			0.8	3JER0.8ISO...		0.49	1.2	0.5			
			1.0	3JER1.0ISO...		0.61	0.7	0.8			
			1.25	3JER1.25ISO...		0.77	0.7	0.8			
			1.5	3JER1.5ISO...		0.92	0.7	0.8			
			1.75	3JER1.75ISO...		1.07	1.2	1.5			
			2.0	3JER2.0ISO...		1.23	1.2	1.5			
			2.5	3JER2.5ISO...		1.53	1.2	1.5			
			3.0	3JER3.0ISO...		1.84	1.3	1.5			
	3/8" V6	16	0.5	3ER0.5ISO-6C...		0.31	2.2	1.8	YE3-6C	-	AL..-3
			0.75	3ER0.75ISO-6C...		0.46	2.0	1.8			
			0.8	3ER0.8ISO-6C...		0.49	2.0	1.9			
			1.0	3ER1.0ISO-6C...		0.61	1.9	2.0			
			1.25	3ER1.25ISO-6C...		0.77	1.8	2.1			
			1.5	3ER1.5ISO-6C...		0.92	1.9	2.4			
			1.75	3ER1.75ISO-6C...		1.07	1.8	2.6			
			2.0	3ER2.0ISO-6C...		1.23	1.9	2.8			
	1/2"	22	3.5	4ER3.5ISO...	4EL3.5ISO...	2.15	1.6	2.3	YE4	YI4	AL..-4 (LH)
			4.0	4ER4.0ISO...	4EL4.0ISO...	2.45	1.6	2.3			
			4.5	4ER4.5ISO...	4EL4.5ISO...	2.76	1.7	2.4			
			5.0	4ER5.0ISO...	4EL5.0ISO...	3.07	1.7	2.5			
			6.0	4ER6.0ISO...	4EL6.0ISO...	3.68	2.0	2.9			
5/8"	27	5.5	5ER5.5ISO...	5EL5.5ISO...	3.37	1.9	2.7	YE5	YI5	AL..-5 (LH)	
		6.0	5ER6.0ISO...	5EL6.0ISO...	3.68	2.0	2.9				

U Typ

Plattengrösse		Teilung	Bestellnummer	Abmessungen mm			Unterlegplatte			
IC	L mm	mm	RH+LH	h min	X	Y	RH	LH	Klemmhalter	
	1/2"U	22	5.0	4UE5.0ISO...	3.07	2.2	11.0	YE4U	YI4U	AL..-4U (LH)
		5.5	4UE5.5ISO...	3.37	2.3	11.0				
		6.0	4UE6.0ISO...	3.68	2.6	11.0				
5/8"U	27	8.0	5UE8.0ISO...	4.91	2.4	13.7	YE5U	YI5U	AL..-5U (LH)	

ISO metrisch (Fortsetzung)

Aussen

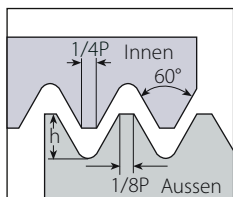

Norm: R262 (DIN 13)
Toleranzklasse: 6g/6H

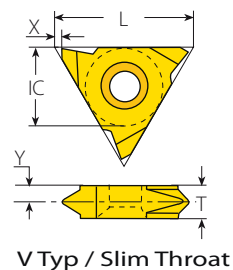

Slim Throat

Plattengrösse		Teilung	Bestellnummer		Abmessungen mm				Klemmhalter
IC	L mm	mm	RH	LH	h min	X	Y	T	
1/4"V	11	0.75	2VER0.75ISO...	2VEL0.75ISO...	0.46	0.7	2.6	3.2	NL...-2V (LH)
		1.0	2VER1.0ISO...	2VEL1.0ISO...	0.61	0.7	2.5	3.2	
		1.5	2VER1.5ISO...	2VEL1.5ISO...	0.92	0.7	2.2	3.2	
		1.75	2VER1.75ISO...	2VEL1.75ISO...	1.07	0.7	2.1	3.2	
		2.0	2VER2.0ISO...	2VEL2.0ISO...	1.23	0.7	1.9	3.2	
3/8"V	16	0.35	3VER0.35ISO...	3VEL0.35ISO...	0.20	1.1	3.25	3.6	NL...-3V (LH)
		0.4	3VER0.4ISO...	3VEL0.4ISO...	0.25	1.1	3.20	3.6	
		0.5	3VER0.5ISO...	3VEL0.5ISO...	0.31	1.1	3.0	3.6	
		0.75	3VER0.75ISO...	3VEL0.75ISO...	0.46	1.1	3.0	3.6	
		0.8	3VER0.8ISO...	3VEL0.8ISO...	0.49	1.1	3.0	3.6	
		1.0	3VER1.0ISO...	3VEL1.0ISO...	0.61	1.1	2.9	3.6	
		1.25	3VER1.25ISO...	3VEL1.25ISO...	0.77	1.1	2.7	3.6	
		1.5	3VER1.5ISO...	3VEL1.5ISO...	0.92	1.1	2.6	3.6	
		1.75	3VER1.75ISO...	3VEL1.75ISO...	1.07	1.1	2.45	3.6	
		2.0	3VER2.0ISO...	3VEL2.0ISO...	1.23	1.1	2.3	3.6	
		2.5	3VER2.5ISO...	3VEL2.5ISO...	1.53	1.1	2.1	3.6	
		3.0	3VER3.0ISO...	3VEL3.0ISO...	1.84	1.1	2.0	3.6	



V Typ

Plattengrösse		Teilung	Bestellnummer		Abmessungen mm				Klemmhalter
IC	L mm	mm	RH	LH	h min	X	Y	T	
5/8"V	27	5.5	5VER5.5ISO...	5VEL5.5ISO...	3.37	1.0	3.3	6	NL...-5V-6 (LH)
		6.0	5VER6.0ISO...	5VEL6.0ISO...	3.68	1.0	3.3	6	
		8.0	5VER8.0ISO...	5VEL8.0ISO...	4.91	1.0	4.3	8	
		10.0	5VER10.0ISO...	5VEL10.0ISO...	6.13	1.0	5.2	10	



ISO metrisch (Fortsetzung)

Aussen

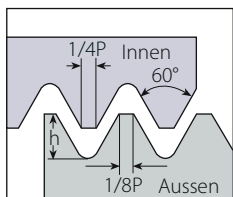

Norm: R262 (DIN 13)
Toleranzklasse: 6g/6H

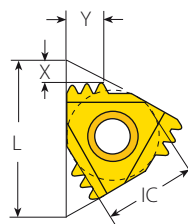

M+ Typ

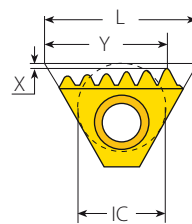

T+ Typ

M+ Typ



Plattengrösse		Teilung	Zähne	Bestellnummer	Abmessungen mm			Unterlegplatte	
IC	L mm	mm		RH	h min	X	Y	RH	Klemmhalter
3/8"	16	1.0	3	3ER1.0ISO3M+...	0.61	1.8	2.6	YE3M	AL..-3
		1.5	2	3ER1.5ISO2M+...	0.92	1.6	2.4		
		2.0	2	3ER2.0ISO2M+...	1.23	2.1	3.1		
1/2"	22	1.5	3	4ER1.5ISO3M+...	0.92	2.5	3.8	YE4M	AL..-4
		2.0	2	4ER2.0ISO2M+...	1.23	2.1	3.1		
		2.0	3	4ER2.0ISO3M+...	1.23	3.2	5.1		
		2.5	2	4ER2.5ISO2M+...	1.53	2.5	3.9		
5/8"	27	3.0	2	5ER3.0ISO2M+...	1.84	3.0	4.7	YE5M	AL..-5M

T+ Typ



Plattengrösse		Teilung	Zähne	Bestellnummer	Abmessungen mm			Unterlegplatte	
IC	L mm	mm		RH	h min	X	Y	RH	Klemmhalter
1/2"	22	1.5	8	4ER1.5ISO8T+...	0.92	0.2	12.4	Y4T	AL..-4T
		2.0	8	4ER2.0ISO8T+...	1.23	0.2	17.5		

ISO metrisch (Fortsetzung)

Innen

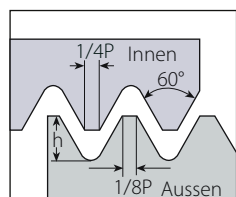

Norm: R262 (DIN 13)
Toleranzklasse: 6g/6H

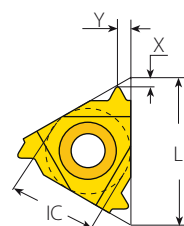

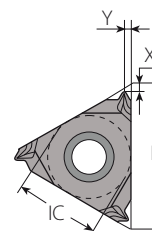

Standard



SCB
Gesinterter
Spanbrecher

Standard

Plattengröße		Teilung	Bestellnummer		Abmessungen mm			Unterlegplatte		Klemmhalter	
IC	L mm	mm	RH	LH	h min	X	Y	RH	LH		
	1/4"	11	0.35	2IR0.35ISO...	2IL0.35ISO...	0.20	0.8	0.3	-	-	NVR..-2 (LH)
			0.4	2IR0.4ISO...	2IL0.4ISO...	0.23	0.8	0.4			
			0.45	2IR0.45ISO...	2IL0.45ISO...	0.26	0.8	0.4			
			0.5	2IR0.5ISO...	2IL0.5ISO...	0.29	0.6	0.4			
			0.6	2IR0.6ISO...	2IL0.6ISO...	0.35	0.6	0.6			
			0.7	2IR0.7ISO...	2IL0.7ISO...	0.40	0.6	0.6			
			0.75	2IR0.75ISO...	2IL0.75ISO...	0.43	0.6	0.6			
			0.8	2IR0.8ISO...	2IL0.8ISO...	0.46	0.6	0.6			
			1.0	2IR1.0ISO...	2IL1.0ISO...	0.58	0.6	0.7			
			1.25	2IR1.25ISO...	2IL1.25ISO...	0.72	0.8	0.9			
			1.5	2IR1.5ISO...	2IL1.5ISO...	0.87	0.8	1.0			
			1.75	2IR1.75ISO...	2IL1.75ISO...	1.01	0.9	1.1			
2.0	2IR2.0ISO...	2IL2.0ISO...	1.15	0.9	1.1						
	1/4" SCB	11	0.5	2JIR0.5ISO...		0.29	1.2	0.5	-	-	NVR..-2
			0.75	2JIR0.75ISO...		0.43	1.2	0.5			
			0.8	2JIR0.8ISO...		0.46	1.2	0.5			
			1.0	2JIR1.0ISO...		0.58	0.7	0.8			
			1.25	2JIR1.25ISO...		0.72	0.7	0.8			
			1.5	2JIR1.5ISO...		0.87	0.7	0.8			
	3/8"	16	0.35	3IR0.35ISO...	3IL0.35ISO...	0.20	0.8	0.3	YI3	YE3	AVR..-3 (LH)
			0.4	3IR0.4ISO...	3IL0.4ISO...	0.23	0.8	0.4			
			0.45	3IR0.45ISO...	3IL0.45ISO...	0.26	0.8	0.4			
			0.5	3IR0.5ISO...	3IL0.5ISO...	0.29	0.6	0.4			
			0.6	3IR0.6ISO...	3IL0.6ISO...	0.35	0.6	0.6			
			0.7	3IR0.7ISO...	3IL0.7ISO...	0.40	0.6	0.6			
			0.75	3IR0.75ISO...	3IL0.75ISO...	0.43	0.6	0.6			
			0.8	3IR0.8ISO...	3IL0.8ISO...	0.46	0.6	0.6			
			1.0	3IR1.0ISO...	3IL1.0ISO...	0.58	0.6	0.7			
			1.25	3IR1.25ISO...	3IL1.25ISO...	0.72	0.8	0.9			
			1.5	3IR1.5ISO...	3IL1.5ISO...	0.87	0.8	1.0			
			1.75	3IR1.75ISO...	3IL1.75ISO...	1.01	0.9	1.2			
			2.0	3IR2.0ISO...	3IL2.0ISO...	1.15	1.0	1.3			
			2.5	3IR2.5ISO...	3IL2.5ISO...	1.44	1.1	1.5			
			3.0	3IR3.0ISO...	3IL3.0ISO...	1.73	1.1	1.5			
3.5	3IR3.5ISO...	3IL3.5ISO...	2.02	1.2	1.5						

Weiter Nächste Seite ▶

ISO metrisch (Fortsetzung)

Innen

Norm: R262 (DIN 13)
Toleranzklasse: 6g/6H





SCB
Gesinterter Spanbrecher

V6

Standard

U Typ

Standard (Fortsetzung)

Plattengröße		Teilung	Bestellnummer		Abmessungen mm			Unterlegplatte		Klemmhalter		
IC	L mm	mm	RH	LH	h min	X	Y	RH	LH			
	3/8"	SCB	16	1.0	3JIR1.0ISO...		0.58	0.7	0.8	Y13	-	AVR..-3
				1.25	3JIR1.25ISO...		0.72	0.7	0.8			
				1.5	3JIR1.5ISO...		0.87	0.7	0.8			
				1.75	3JIR1.75ISO...		1.01	1.1	1.5			
				2.0	3JIR2.0ISO...		1.15	1.1	1.5			
				2.5	3JIR2.5ISO...		1.44	1.1	1.5			
				3.0	3JIR3.0ISO...		1.73	1.1	1.5			
	3/8"	V6	16	0.5	3IR0.5ISO-6C...		0.29	2.1	1.7	Y13-6C	-	AVR..-3 NVRC..-3 206/
				0.75	3IR0.75ISO-6C...		0.43	2.0	1.8			
				0.8	3IR0.8ISO-6C...		0.46	1.9	1.8			
				1.0	3IR1.0ISO-6C...		0.58	1.9	1.6			
				1.25	3IR1.25ISO-6C...		0.72	1.7	2.0			
				1.5	3IR1.5ISO-6C...		0.87	1.5	2.1			
				1.75	3IR1.75ISO-6C...		1.01	1.6	2.4			
	1/2"	Standard	22	3.5	4IR3.5ISO...	4IL3.5ISO...	2.02	1.6	2.3	Y14	YE4	AVR..-4 (LH)
				4.0	4IR4.0ISO...	4IL4.0ISO...	2.31	1.6	2.3			
				4.5	4IR4.5ISO...	4IL4.5ISO...	2.60	1.6	2.4			
				5.0	4IR5.0ISO...	4IL5.0ISO...	2.89	1.6	2.3			
				6.0	4IR6.0ISO...	4IL6.0ISO...	3.46	1.8	2.5			
	5/8"	U Typ	27	4.5	5IR4.5ISO...	5IL4.5ISO...	2.60	1.6	2.4	Y15	YE5	AVR..-5 (LH)
				5.0	5IR5.0ISO...	5IL5.0ISO...	2.89	1.6	2.3			
				5.5	5IR5.5ISO...	5IL5.5ISO...	3.17	1.6	2.3			
				6.0	5IR6.0ISO...	5IL6.0ISO...	3.46	1.8	2.5			

U Typ

Plattengröße		Teilung	Bestellnummer	Abmessungen mm			Unterlegplatte		Klemmhalter	
IC	L mm	mm	RH+LH	h min.	X	Y	RH	LH		
	1/2"U	22	5.5	4UI5.5ISO...	3.17	2.4	11.0	Y14U	YE4U	AVR..-4U (LH)
		6.0	4UI6.0ISO...	3.46	2.1	11.0				
5/8"U	27	8.0	5UI8.0ISO...	4.62	2.4	13.7	Y15U	YE5U	AVR..-5U (LH)	

ISO metrisch (Fortsetzung)

Innen

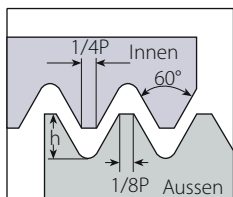

Norm: R262 (DIN 13)
Toleranzklasse: 6g/6H

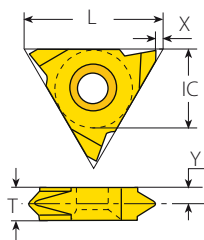

V Typ

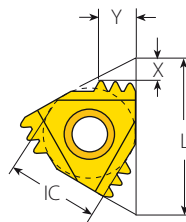

M+ Typ

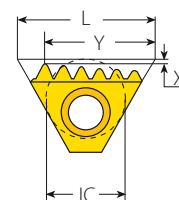

T+ Typ

V Typ



Plattengröße		Teilung	Bestellnummer		Abmessungen mm				Klemmhalter
IC	L mm	mm	RH	LH	h min	X	Y	T	
5/8"V	27	6.0	5VIR6.0ISO...	5VIL6.0ISO...	3.46	1.0	3.3	6	NVR..-5V (LH)
		8.0	5VIR8.0ISO...	5VIL8.0ISO...	4.62	1.0	4.3	8	
		10.0	5VIR10.0ISO...	5VIL10.0ISO...	5.77	1.0	5.2	10	

M+ Typ



Plattengröße		Teilung	Zähne	Bestellnummer	Abmessungen mm			Unterlegplatte	Klemmhalter
IC	L mm	mm		RH	h min	X	Y	RH	
3/8"	16	1.0	3	3IR1.0ISO3M+...	0.58	1.7	2.6	Y13M	AVR..-3
		1.5	2	3IR1.5ISO2M+...	0.87	1.6	2.4		
		2.0	2	3IR2.0ISO2M+...	1.15	2.0	3.1		
1/2"	22	1.5	3	4IR1.5ISO3M+...	0.87	2.5	3.8	Y14M	AVR..-4
		2.0	2	4IR2.0ISO2M+...	1.15	2.0	3.1		
		2.0	3	4IR2.0ISO3M+...	1.15	3.2	5.1		
5/8"	27	3.0	2	5IR3.0ISO2M+...	1.73	3.0	4.7	Y15M	AVR..-5M

T+ Typ



Plattengröße		Teilung	Zähne	Bestellnummer	Abmessungen mm			Unterlegplatte	Klemmhalter
IC	L mm	mm		RH	h min	X	Y	RH	
1/2"	22	1.5	8	4IR1.5ISO8T+...	0.87	0.2	12.4	Y4T	AVR..-4T
		2.0	8	4IR2.0ISO8T+...	1.15	0.2	17.5		

ISO metrisch (Fortsetzung)



Innen

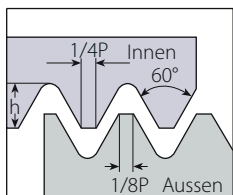

Norm: R262 (DIN 13)
Toleranzklasse: 6g/6H

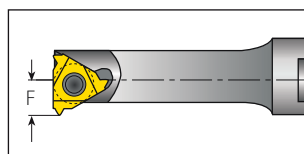
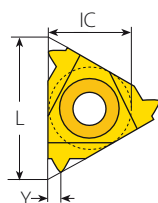

Mini3-Gewinde

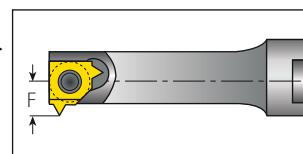
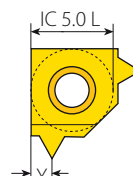

Mini-L-Gewinde

Mini-3 - Gewinde

Plattengröße		Teilung	Bestellnummer	Abmessungen mm			Min. Bohrungsdurchmesser	
IC	L mm	mm	RH	h min	Y	F	mm	Klemmhalter
4.0	6	0.25	4.0KIR0.25ISO...	0.15	0.25	3.3	5.95	.NVR.5-4.0K
		0.5	4.0KIR0.5ISO...	0.29	0.5	3.4	6.05	
		0.75	4.0KIR0.75ISO...	0.43	0.5	3.5	6.15	
		1.0	4.0KIR1.0ISO...	0.58	0.7	3.6	6.25	
		1.25	4.0KIR1.25ISO...	0.72	0.6	3.7	6.35	
6.0	10	0.5	6.0IR0.5ISO...	0.29	0.6	4.4	9.3	.NVR1..-6.0
		0.75	6.0IR0.75ISO...	0.43	0.6	4.6	9.5	
		1.0	6.0IR1.0ISO...	0.58	0.7	4.7	9.6	
		1.25	6.0IR1.25ISO...	0.72	0.9	4.9	9.8	
		1.5	6.0IR1.5ISO...	0.87	1.0	5.0	9.9	
		1.75	6.0IR1.75ISO...	1.01	1.05	5.2	10.0	
		2.0	6.0IR2.0ISO...	1.15	1.05	5.3	10.0	



Mini-L - Gewinde

Plattengröße		Teilung	Bestellnummer	Abmessungen mm			Min. Bohrungsdurchmesser	
IC mm		mm	RH	h min	Y	F	mm	Klemmhalter
5.0L		0.35	5LIR0.35ISO...	0.20	0.3	3.75	7.3	.NVR10.-5L
		0.5	5LIR0.5ISO...	0.29	0.4	3.75	7.3	
		0.75	5LIR0.75ISO...	0.43	0.6	3.91	7.5	
		1.0	5LIR1.0ISO...	0.58	0.7	4.06	7.7	
		1.25	5LIR1.25ISO...	0.72	0.9	4.21	7.8	
		1.5	5LIR1.5ISO...	0.87	1.0	4.35	7.9	
		1.75	5LIR1.75ISO...	1.01	1.05	4.51	8.0	
		2.0	5LIR2.0ISO...	1.15	1.05	4.65	8.0	



ISO metrisch (Fortsetzung)



Innen

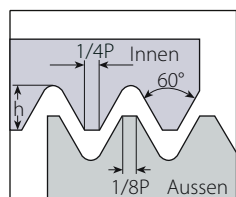

Norm: R262 (DIN 13)
Toleranzklasse: 6g/6H

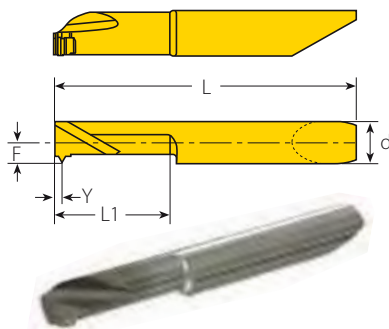

RH - Einseitig

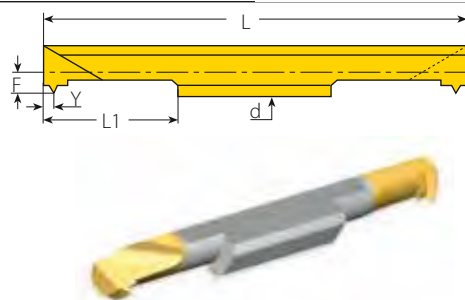

RH - Zweiseitig

Micro - Zweiseitig

Gewinde	Einsatzdurchmesser		Teilung	Bestellnummer	Abmessungen mm					Min. Bohrungsdurchmesser	Klemmhalter
	d mm	mm			RH/LH	L1	L	F	Y		
M4 x 0.3	3.0		0.3	3.0SIR0.3ISO...	16	50	1.31	0.20	0.17	3.2	SMC...-3.0
M4 x 0.4			0.4	3.0SIR0.4ISO...	16	50	1.31	0.35	0.22	3.2	
M4 x 0.5			0.5	3.0SIR0.5ISO...	16	50	1.31	0.40	0.29	3.2	
M4 x 0.6			0.6	3.0SIR0.6ISO...	16	50	1.34	0.60	0.35	3.2	
M4.5 x 0.7			0.7	3.0SIR0.7ISO...	16	50	1.43	0.60	0.40	3.3	
M4.5 x 0.75			0.75	3.0SIR0.75ISO...	16	50	1.45	0.60	0.43	3.3	
M5 x 0.8	4.0		0.8	3.0SIR0.8ISO...	16	50	1.46	0.60	0.46	3.3	SMC...-4.0
M5 x 0.4			0.4	4.0SIR0.4ISO...	16	50	1.65	0.35	0.22	4.0	
M5 x 0.5			0.5	4.0SIR0.5ISO...	16	50	1.65	0.40	0.29	4.0	
M5 x 0.6			0.6	4.0SIR0.6ISO...	16	50	1.68	0.60	0.35	4.0	
M5 x 0.7			0.7	4.0SIR0.7ISO...	16	50	1.77	0.60	0.40	4.1	
M5.5 x 0.75			0.75	4.0SIR0.75ISO...	16	50	1.81	0.60	0.43	4.2	
M5.5 x 0.8	0.8	4.0SIR0.8ISO...	16	50	1.80	0.60	0.46	4.2	SMC...-6.0		
M6 x 1	1.0	4.0SIR1.0ISO...	16	50	1.96	0.90	0.58	4.3			
M6 x 0.5	0.5	6.0SIR0.5ISO...	16	50	1.90	0.60	0.29	5.4			
M6.5 x 0.75	0.75	6.0SIR0.75ISO...	16	50	2.06	0.60	0.43	5.6			
M7 x 1	1.0	6.0SIR1.0ISO...	16	50	2.21	0.70	0.58	5.7			
M8 x 1.25	1.25	6.0SIR1.25ISO...	16	50	2.36	0.90	0.72	5.9			
M10.5 x 1.5	1.5	6.0SIR1.5ISO...	16	50	2.50	1.00	0.87	6.0			

LH Werkzeug lieferbar auf Anfrage. (Beispiel: 3.0SIL0.3ISO...)

Micro - Einseitig



Gewinde	Einsatzdurchmesser		Teilung	Bestellnummer	Abmessungen mm					Min. Bohrungsdurchmesser	Klemmhalter
	d mm	mm			RH/LH	L1	L	F	Y		
M4x0.5	4.0		0.5	M429TH 0.50ISO L16R/L	16	33	0.9	0.4	0.29	3.4	MHC...-4
M5x0.5			0.5	M439TH 0.50ISO L16R/L	16	33	1.9	0.4	0.29	4.4	
M4x0.7			0.7	M429TH 0.70ISO L16R/L	16	33	0.9	0.5	0.41	3.2	
M5x0.8			0.8	M429TH 0.80ISO L16R/L	16	33	0.9	0.6	0.46	4.0	
M6x1			1.0	M439TH 1.00ISO L16R/L	16	33	1.9	0.7	0.58	4.8	
M5.5x0.5			0.5	M542TH 0.50ISO L16R/L	16	41	1.7	0.4	0.29	4.9	
M5.5x0.75	0.75	M542TH 0.75ISO L16R/L	16	41	1.7	0.6	0.43	4.6			
M7x1	1.0	M549TH 1.00ISO L16R/L	16	41	2.4	0.7	0.58	5.8			
M6x0.5	0.5	M649TH 0.50ISO L16R/L	16	42	1.9	0.4	0.29	5.4			
M6.5x0.75	0.75	M649TH 0.75ISO L16R/L	16	42	1.9	0.6	0.43	5.6			
M7.5x1	1.0	M659TH 1.00ISO L16R/L	16	42	2.9	0.7	0.58	6.3	MHC...-6		
M8x1.25	1.25	M659TH 1.25ISO L16R/L	16	42	2.9	0.9	0.72	6.5			
M10x1.5	1.5	M659TH 1.50ISO L16R/L	16	42	2.9	1.0	0.87	8.3			

LH Werkzeug lieferbar auf Anfrage. (Beispiel: M429TH 0.50ISO L16L)

American UN - UNC, UNF, UNEF, UNS

Aussen

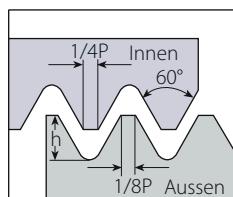

Norm: ANSI B1.1:74
Toleranzklasse: 2A/2B

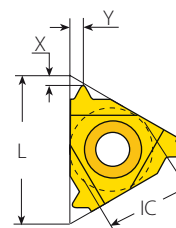

Standard

Standard

Plattengrösse		Teilung	Bestellnummer		Abmessungen mm			Unterlegplatte		Klemmhalter
IC	L mm	G/Z	RH	LH	h min	X	Y	RH	LH	
1/4"	11	72	2ER72UN...	2EL72UN...	0.22	0.8	0.4	-	-	NL ..-2 (LH)
		64	2ER64UN...	2EL64UN...	0.24	0.8	0.4			
		56	2ER56UN...	2EL56UN...	0.28	0.7	0.4			
		48	2ER48UN...	2EL48UN...	0.32	0.6	0.6			
		44	2ER44UN...	2EL44UN...	0.35	0.6	0.6			
		40	2ER40UN...	2EL40UN...	0.39	0.6	0.6			
		36	2ER36UN...	2EL36UN...	0.43	0.6	0.6			
		32	2ER32UN...	2EL32UN...	0.49	0.6	0.6			
		28	2ER28UN...	2EL28UN...	0.56	0.6	0.7			
		27	2ER27UN...	2EL27UN...	0.58	0.7	0.8			
		24	2ER24UN...	2EL24UN...	0.65	0.7	0.8			
		20	2ER20UN...	2EL20UN...	0.78	0.8	0.9			
		18	2ER18UN...	2EL18UN...	0.87	0.8	1.0			
		16	2ER16UN...	2EL16UN...	0.97	0.9	1.1			
3/8"	16	80	3ER80UN...	3EL80UN...	0.18	0.8	0.3	YE3	YI3	AL..-3 (LH)
		72	3ER72UN...	3EL72UN...	0.22	0.8	0.4			
		64	3ER64UN...	3EL64UN...	0.24	0.8	0.4			
		56	3ER56UN...	3EL56UN...	0.28	0.7	0.4			
		48	3ER48UN...	3EL48UN...	0.32	0.6	0.6			
		44	3ER44UN...	3EL44UN...	0.35	0.6	0.6			
		40	3ER40UN...	3EL40UN...	0.39	0.6	0.6			
		36	3ER36UN...	3EL36UN...	0.43	0.6	0.6			
		32	3ER32UN...	3EL32UN...	0.49	0.6	0.6			
		28	3ER28UN...	3EL28UN...	0.56	0.6	0.7			
		27	3ER27UN...	3EL27UN...	0.58	0.7	0.8			
		24	3ER24UN...	3EL24UN...	0.65	0.7	0.8			
		20	3ER20UN...	3EL20UN...	0.78	0.8	0.9			
		18	3ER18UN...	3EL18UN...	0.87	0.8	1.0			
		16	3ER16UN...	3EL16UN...	0.97	0.9	1.1			
		14	3ER14UN...	3EL14UN...	1.11	1.0	1.2			
13	3ER13UN...	3EL13UN...	1.20	1.0	1.3					
12	3ER12UN...	3EL12UN...	1.30	1.1	1.4					
11.5	3ER11.5UN...	3EL11.5UN...	1.35	1.1	1.5					
11	3ER11UN...	3EL11UN...	1.42	1.1	1.5					
10	3ER10UN...	3EL10UN...	1.56	1.1	1.5					
9	3ER9UN...	3EL9UN...	1.73	1.2	1.7					
8	3ER8UN...	3EL8UN...	1.95	1.2	1.6					



American UN - UNC, UNF, UNEF, UNS (Fortsetzung)

Aussen

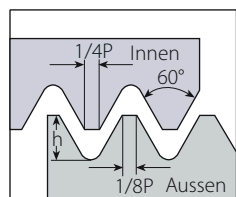

Norm: ANSI B1.1:74
Toleranzklasse: 2A/2B

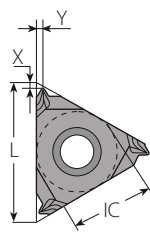

SCB
Gesinterter
Spanbrecher

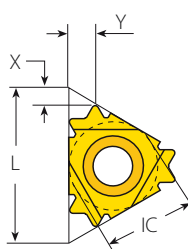

V6

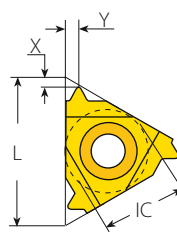



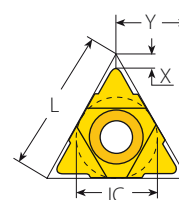

Standard



U Typ

Standard (Fortsetzung)

Plattengrösse		Teilung	Bestellnummer		Abmessungen mm			Unterlegplatte		Klemmhalter	
IC	L mm	G/Z	RH	LH	h min	X	Y	RH	LH		
 SCB	3/8" SCB	16	36	3JER36UN...		0.43	1.2	0.5	YE3	-	AL..-3
			32	3JER32UN...		0.49	1.2	0.5			
			28	3JER28UN...		0.56	0.7	0.8			
			24	3JER24UN...		0.65	0.7	0.8			
			20	3JER20UN...		0.78	0.7	0.8			
			18	3JER18UN...		0.87	0.7	0.8			
			16	3JER16UN...		0.97	0.8	0.8			
			14	3JER14UN...		1.11	1.2	1.5			
			13	3JER13UN...		1.20	1.2	1.5			
			12	3JER12UN...		1.30	1.3	1.5			
			10	3JER10UN...		1.56	1.2	1.5			
			9	3JER9UN...		1.73	1.2	1.5			
8	3JER8UN...		1.95	1.3	1.5						
 V6	3/8" V6	16	32	3ER32UN-6C...		0.49	2.0	1.9	YE3-6C	-	AL..-3
			28	3ER28UN-6C...		0.56	2.0	2.0			
			24	3ER24UN-6C...		0.65	1.9	2.0			
			20	3ER20UN-6C...		0.78	1.8	2.1			
			18	3ER18UN-6C...		0.87	1.9	2.3			
			16	3ER16UN-6C...		0.97	1.8	2.4			
			14	3ER14UN-6C...		1.11	1.8	2.7			
			13	3ER13UN-6C...		1.20	1.9	2.9			
 Standard	1/2"	22	7	4ER7UN...	4EL7UN...	2.22	1.6	2.3	YE4	YI4	AL..-4 (LH)
			6	4ER6UN...	4EL6UN...	2.60	1.6	2.3			
			5	4ER5UN...	4EL5UN...	3.12	1.7	2.5			
 U Typ	5/8"	27	4.5	5ER4.5UN...	5EL4.5UN...	3.46	1.9	2.7	YE5	YI5	AL..-5 (LH)
			4	5ER4UN...	5EL4UN...	3.89	2.1	3.0			

U Typ

Plattengrösse		Teilung	Bestellnummer		Abmessungen mm			Unterlegplatte		Klemmhalter
IC	L mm	G/Z	RH+LH	h min	X	Y	RH	LH		
1/2"U	22	4.5	4UE4.5UN...	3.46	2.0	11.0	YE4U	YI4U	AL..-4U (LH)	
		4	4UE4UN...	3.89	2.0	11.0				
5/8"U	27	3	5UE3UN...	5.19	2.5	13.7	YE5U	YI5U	AL..-5U (LH)	

American UN - UNC, UNF, UNEF, UNS (Fortsetzung)

Aussen

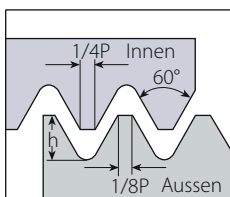

Norm: ANSI B1.1:74
Toleranzklasse: 2A/2B

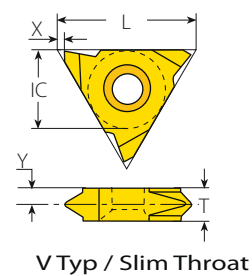

V Typ / Slim Throat

Slim Throat

Plattengrösse		Teilung	Bestellnummer		Abmessungen mm				Klemmhalter
IC	L mm	G/Z	RH	LH	h min	X	Y	T	
1/4"V	11	20	2VER20UN...	2VEL20UN...	0.78	0.69	2.3	3.2	NL...-2V (LH)
		18	2VER18UN...	2VEL18UN...	0.87	0.69	2.2	3.2	
		16	2VER16UN...	2VEL16UN...	0.97	0.69	2.2	3.2	
		14	2VER14UN...	2VEL14UN...	1.11	0.69	2.0	3.2	
		12	2VER12UN...	2VEL12UN...	1.30	0.69	1.8	3.2	
3/8"V	16	32	3VER32UN...	3VEL32UN...	0.48	1.1	3.0	3.6	NL...-3V (LH)
		28	3VER28UN...	3VEL28UN...	0.56	1.1	3.0	3.6	
		24	3VER24UN...	3VEL24UN...	0.65	1.1	2.9	3.6	
		20	3VER20UN...	3VEL20UN...	0.78	1.1	2.7	3.6	
		18	3VER18UN...	3VEL18UN...	0.87	1.1	2.6	3.6	
		16	3VER16UN...	3VEL16UN...	0.97	1.1	2.55	3.6	
		14	3VER14UN...	3VEL14UN...	1.11	1.1	2.4	3.6	
		12	3VER12UN...	3VEL12UN...	1.30	1.1	2.2	3.6	
1/2"V	22	7	4VER7UN...	4VEL7UN...	2.22	1.1	2.5	4.8	NL...-4V (LH)



V Typ

Plattengrösse		Teilung	Bestellnummer		Abmessungen mm				Klemmhalter
IC	L mm	G/Z	RH	LH	h min	X	Y	T	
5/8"V	27	4	5VER4UN...	5VEL4UN...	3.89	1.0	3.3	6	NL...-5V-6 (LH)
		3	5VER3UN...	5VEL3UN...	5.19	1.0	4.3	8	NL...-5V-8 (LH)



American UN - UNC, UNF, UNEF, UNS (Fortsetzung)

Aussen

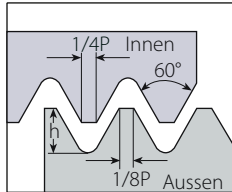

Norm: ANSI B1.1:74
Toleranzklasse: 2A/2B

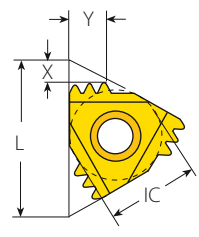

M+ Typ

M+ Typ



Plattengrösse		Teilung	Zähne	Bestellnummer	Abmessungen mm			Unterlegplatte	
IC	L mm	G/Z		RH	h min	X	Y	RH	Klemmhalter
3/8"	16	20	3	3ER20UN3M+...	0.78	2.2	3.3	YE3M	AL..-3
		18	2	3ER18UN2M+...	0.87	1.5	2.2		
		18	3	3ER18UN3M+...	0.87	2.3	3.6		
		16	2	3ER16UN2M+...	0.97	1.7	2.5		
		14	2	3ER14UN2M+...	1.11	1.9	2.8		
		12	2	3ER12UN2M+...	1.3	2.2	3.3		
1/2"	22	16	3	4ER16UN3M+...	0.97	2.6	4.1	YE4M	AL..-4
		14	2	4ER14UN2M+...	1.11	1.9	2.8		
		12	2	4ER12UN2M+...	1.3	2.2	3.3		
		12	3	4ER12UN3M+...	1.3	3.4	5.4		
		11	2	4ER11UN2M+...	1.42	2.3	3.6		
5/8"	27	8	2	5ER8UN2M+...	1.95	3.1	4.9	YE5M	AL..-5M

American UN - UNC, UNF, UNEF, UNS (Fortsetzung)

Innen

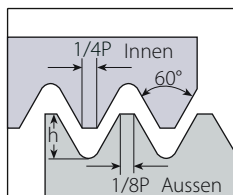

Norm: ANSI B1.1:74
Toleranzklasse: 2A/2B

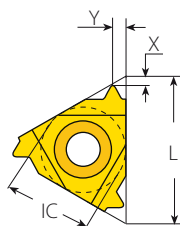

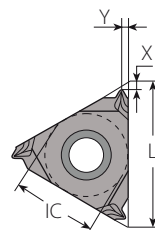

Standard



SCB
Gesinterter
Spanbrecher

Standard (Fortsetzung)

Plattengröße		Teilung	Bestellnummer		Abmessungen mm			Unterlegplatte		Klemmhalter	
IC	L mm	G/Z	RH	LH	h min	X	Y	RH	LH		
	1/4"	11	72	2IR72UN...	2IL72UN...	0.20	0.8	0.3	-	-	NVR..-2 (LH)
			64	2IR64UN...	2IL64UN...	0.23	0.8	0.4			
			56	2IR56UN...	2IL56UN...	0.26	0.7	0.4			
			48	2IR48UN...	2IL48UN...	0.31	0.6	0.6			
			44	2IR44UN...	2IL44UN...	0.33	0.6	0.6			
			40	2IR40UN...	2IL40UN...	0.37	0.6	0.6			
			36	2IR36UN...	2IL36UN...	0.41	0.6	0.6			
			32	2IR32UN...	2IL32UN...	0.46	0.6	0.6			
			28	2IR28UN...	2IL28UN...	0.52	0.6	0.7			
			27	2IR27UN...	2IL27UN...	0.54	0.7	0.8			
			24	2IR24UN...	2IL24UN...	0.61	0.7	0.8			
			20	2IR20UN...	2IL20UN...	0.73	0.8	0.9			
			18	2IR18UN...	2IL18UN...	0.81	0.8	1.0			
			16	2IR16UN...	2IL16UN...	0.92	0.9	1.1			
14	2IR14UN...	2IL14UN...	1.05	0.9	1.1						
12	2IR12UN...	2IL12UN...	1.22	0.8	1.1						
11	2IR11UN...	2IL11UN...	1.33	0.8	1.1						
 SCB	1/4"	11	36	2JIR36UN...		0.41	1.1	0.5	-	-	NVR..-2
			32	2JIR32UN...		0.46	1.2	0.5			
			28	2JIR28UN...		0.52	0.6	0.8			
			24	2JIR24UN...		0.61	0.7	0.8			
			20	2JIR20UN...		0.73	0.6	0.8			
			18	2JIR18UN...		0.81	0.6	0.8			
16	2JIR16UN...		0.97	0.7	0.8						
	3/8"	16	72	3IR72UN...	3IL72UN...	0.20	0.8	0.3	Y13	YE3	AVR..-3 (LH)
			64	3IR64UN...	3IL64UN...	0.23	0.8	0.4			
			56	3IR56UN...	3IL56UN...	0.26	0.7	0.4			
			48	3IR48UN...	3IL48UN...	0.31	0.6	0.6			
			44	3IR44UN...	3IL44UN...	0.33	0.6	0.6			
			40	3IR40UN...	3IL40UN...	0.37	0.6	0.6			
			36	3IR36UN...	3IL36UN...	0.41	0.6	0.6			
			32	3IR32UN...	3IL32UN...	0.51	0.6	0.6			
			28	3IR28UN...	3IL28UN...	0.52	0.6	0.7			
			27	3IR27UN...	3IL27UN...	0.54	0.7	0.8			

Weiter Nächste Seite ▶

American UN - UNC, UNF, UNEF, UNS (Fortsetzung)

Innen

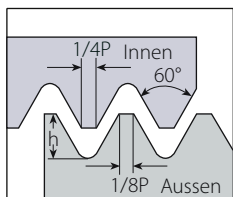

Norm: ANSI B1.1:74
Toleranzklasse: 2A/2B

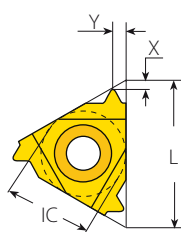

Standard

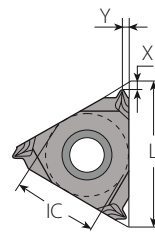



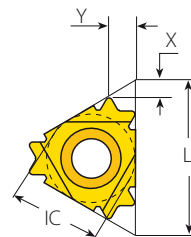

SCB
Gesinterter
Spanbrecher



V6

Standard (Fortsetzung)

Plattengröße		Teilung	Bestellnummer		Abmessungen mm			Unterlegplatte		Klemmhalter	
IC	L mm	G/Z	RH	LH	h min	X	Y	RH	LH		
	3/8"	16	24	3IR24UN...	3IL24UN...	0.61	0.7	0.8	Y13	YE3	AVR.-3 (LH)
			20	3IR20UN...	3IL20UN...	0.73	0.8	0.9			
			18	3IR18UN...	3IL18UN...	0.81	0.8	1.0			
			16	3IR16UN...	3IL16UN...	0.92	0.9	1.1			
			14	3IR14UN...	3IL14UN...	1.05	0.9	1.2			
			13	3IR13UN...	3IL13UN...	1.13	1.0	1.3			
			12	3IR12UN...	3IL12UN...	1.22	1.1	1.4			
			11.5	3IR11.5UN...	3IL11.5UN...	1.28	1.1	1.5			
			11	3IR11UN...	3IL11UN...	1.33	1.1	1.5			
			10	3IR10UN...	3IL10UN...	1.47	1.1	1.5			
			9	3IR9UN...	3IL9UN...	1.63	1.2	1.7			
8	3IR8UN...	3IL8UN...	1.83	1.1	1.5						
 SCB	3/8" SCB	16	28	3JIR28UN...		0.52	0.6	0.8	Y13	-	AVR.-3
			24	3JIR24UN...		0.61	0.7	0.8			
			20	3JIR20UN...		0.73	0.6	0.8			
			18	3JIR18UN...		0.81	0.6	0.8			
			16	3JIR16UN...		0.92	0.7	0.8			
			14	3JIR14UN...		1.05	1.1	1.5			
			13	3JIR13UN...		1.13	1.1	1.5			
			12	3JIR12UN...		1.22	1.1	1.5			
			10	3JIR10UN...		1.47	1.1	1.5			
9	3JIR9UN...		1.63	1.0	1.5						
8	3JIR8UN...		1.83	1.1	1.5						
 V6	3/8" V6	16	32	3IR32UN-6C...		0.51	2.0	1.8	Y13-6C	-	AVR.-3 NVRC.-3 206/...
			28	3IR28UN-6C...		0.52	1.9	1.9			
			24	3IR24UN-6C...		0.61	1.9	1.9			
			20	3IR20UN-6C...		0.73	1.8	2.1			
			18	3IR18UN-6C...		0.81	1.7	2.1			
			16	3IR16UN-6C...		0.92	1.6	2.2			
			14	3IR14UN-6C...		1.05	1.7	2.5			
			13	3IR13UN-6C...		1.13	1.8	2.7			
12	3IR12UN-6C...		1.22	1.6	2.5						
	1/2"	22	7	4IR7UN...	4IL7UN...	2.09	1.6	2.3	Y14	YE4	AVR.-4 (LH)
			6	4IR6UN...	4IL6UN...	2.44	1.6	2.3			
			5	4IR5UN...	4IL5UN...	2.93	1.6	2.3			
	5/8"	27	4.5	5IR4.5UN...	5IL4.5UN...	3.26	1.7	2.4	Y15	YE5	AVR.-5 (LH)
			4	5IR4UN...	5IL4UN...	3.67	1.8	2.7			

American UNC

Innen

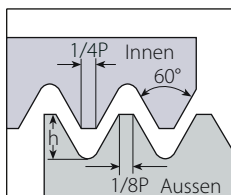

Norm: ANSI B1.1:74
Toleranzklasse: 2A/2B

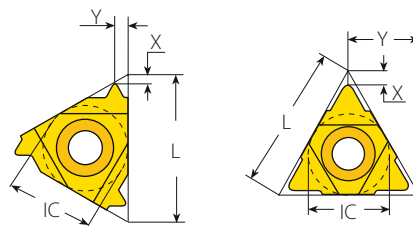

Standard

U+ Typ

Regelgewinde



Gewinde	Plattengröße		Bestellnummer	Abmessungen mm				Klemmhalter	Min. Bohrungsdurchmesser mm
	IC	L mm		RH/LH	h min	X	Y		
1/2 x 13UN	6.0	10	6.0IR13UN...158/001	1.13	0.8	0.9	BNVR10S-6.0	10.6	
9/16 x 12UN	1/4"	11	2IR12UN...158/002	1.22	0.9	1.0	NVRC10-2 156/001	12.0	
5/8 x 11UN	1/4"U		2UIR11UN...158/003	1.33	1.2	5.5	NVRC11-2U 156/002	13.4	
3/4 x 10UN	3/8"	16	3IR10UN...	1.47	1.1	1.5	NVRC13-3 156/016	16.3	
7/8 x 9UN			3IR9UN...	1.63	1.2	1.7	NVRC13-3 156/016	19.2	
1 x 8UN			3IR8UN...	1.83	1.1	1.5	NVRC16-3	22.0	
1 1/8 x 7UN	1/2"	22	4IR7UN...	2.09	1.6	2.3	NVRC20-4	24.6	
1 1/4 x 7UN			4IR7UN...	2.09	1.6	2.3	NVRC20-4	27.8	
1 3/8 x 6UN			4IR6UN...	2.44	1.6	2.3	NVRC20-4	30.3	

LH Werkzeug lieferbar auf Anfrage.

U-Typ Gewindeschneidplatten können für linke und rechte Anwendungen verwendet werden

American UN - UNC, UNF, UNEF, UNS (Fortsetzung)

Innen

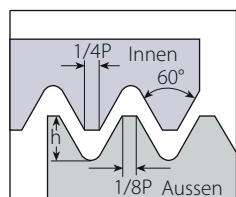

Norm: ANSI B1.1:74
Toleranzklasse: 2A/2B

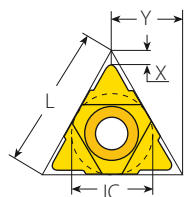

U Typ

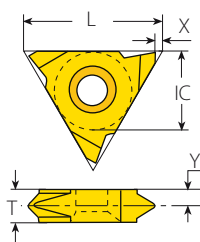

V Typ

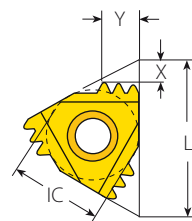

M+ Typ

U Typ



Plattengrösse		Teilung	Bestellnummer		Abmessungen mm			Unterlegplatte		Klemmhalter
IC	L mm	G/Z	RH+LH	h min	X	Y	RH	LH		
1/2"U	22	4.5	4UI4.5UN...	3.26	2.4	11.0	YI4U	YE4U	AVR...-4U (LH)	
		4	4UI4UN...	3.67	2.4	11.0				
5/8"U	27	3	5UI3UN...	4.89	2.7	13.7	YI5U	YE5U	AVR...-5U (LH)	

V Typ



Plattengrösse		Teilung	Bestellnummer		Abmessungen mm				Klemmhalter
IC	L mm	G/Z	RH	LH	h min	X	Y	T	
5/8"V	27	4	5VIR4UN...	5VIL4UN...	3.67	1.0	3.3	6	NVR...-5V (LH)
		3	5VIR3UN...	5VIL3UN...	4.89	1.0	4.3	8	

M+ Typ



Plattengrösse		Teilung	Zähne	Bestellnummer		Abmessungen mm			Unterlegplatte	
IC	L mm	G/Z		RH	h min	X	Y	RH	Klemmhalter	
3/8"	16	12	2	3IR12UN2M+...	1.22	2.2	3.3	YI3M	AVR...-3	
		14	2	3IR14UN2M+...	1.05	1.9	2.8			
		16	2	3IR16UN2M+...	0.92	1.7	2.5			
1/2"	22	16	3	4IR16UN3M+...	0.92	2.6	4.1	YI4M	AVR...-4	
		14	2	4IR14UN2M+...	1.05	1.9	2.8			
		12	2	4IR12UN2M+...	1.22	2.2	3.3			
		12	3	4IR12UN3M+...	1.22	3.4	5.4			
5/8"	27	8	2	5IR8UN2M+...	1.83	3.1	4.9	YI5M	AVR...-5M	

American UN - UNC, UNF, UNEF, UNS (Fortsetzung)



Innen

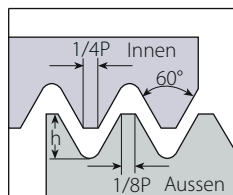

Norm: ANSI B1.1:74
Toleranzklasse: 2A/2B

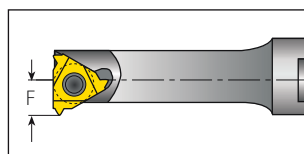
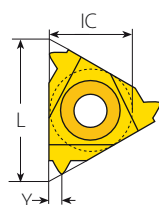

Mini3-Gewinde

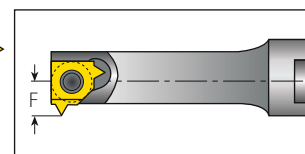
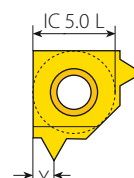

Mini-L-Gewinde

Mini-3 - Gewinde

Plattengrösse		Teilung	Bestellnummer	Abmessungen mm			Min. Bohrungsdurchmesser	Klemmhalter
IC	L mm	G/Z	RH	h min	Y	F	mm	
4.0	6	32	4.0KIR32UN...	0.46	0.5	3.50	6.15	.NVR.5-4.0K
		28	4.0KIR28UN...	0.52	0.6	3.50	6.15	
		24	4.0KIR24UN...	0.61	0.6	3.60	6.25	
		20	4.0KIR20UN...	0.73	0.6	3.70	6.35	
		18	4.0KIR18UN...	0.81	0.7	3.70	6.35	
6.0	10	40	6.0IR40UN...	0.37	0.6	4.50	9.5	.NVR1..-6.0
		32	6.0IR32UN...	0.46	0.6	4.60	9.5	
		28	6.0IR28UN...	0.52	0.65	4.70	9.6	
		24	6.0IR24UN...	0.61	0.75	4.80	9.7	
		20	6.0IR20UN...	0.73	0.9	4.90	9.8	
		18	6.0IR18UN...	0.81	1.0	5.00	9.9	
		16	6.0IR16UN...	0.92	1.05	5.10	10.0	
14	6.0IR14UN...	1.05	1.05	5.20	10.0			



Mini-L - Gewinde

Plattengrösse		Teilung	Bestellnummer	Abmessungen mm			Min. Bohrungsdurchmesser	Klemmhalter
IC mm	G/Z	RH	h min	Y	F	mm		
5.0L	32	5LIR32UN...	0.46	0.6	3.92	7.5	.NVR10.-5L	
	28	5LIR28UN...	0.52	0.65	3.99	7.6		
	24	5LIR24UN...	0.61	0.75	4.09	7.7		
	20	5LIR20UN...	0.73	0.9	4.21	7.8		
	18	5LIR18UN...	0.81	1.0	4.30	7.9		
	16	5LIR16UN...	0.92	1.05	4.41	8.0		
	14	5LIR14UN...	1.05	1.05	4.54	8.0		



American UN - UNC, UNF, UNEF, UNS (Fortsetzung)



Innen

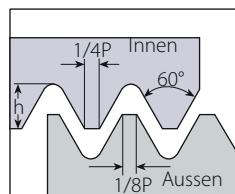

Norm: ANSI B1.1:74
Toleranzklasse: 2A/2B

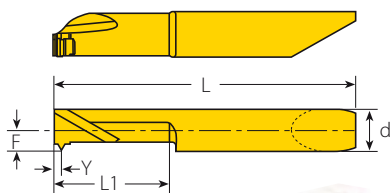

RH - Einseitig

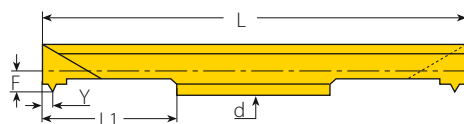

RH - Zweiseitig

Micro - Zweiseitig

Gewinde	Einsatzdurchmesser		Teilung	Bestellnummer	Abmessungen mm					Min. Bohrungsdurchmesser		Klemmhalter
	d mm	mm			RH/LH	L1	L	F	Y	h min	mm	
10-40UNS	3.0		40	3.0SIR40UN...	16	50	1.35	0.60	0.37	3.2	SMC..-3.0	
8-36UNF			36	3.0SIR36UN...	16	50	1.46	0.60	0.41	3.2		
8-32UNF			32	3.0SIR32UN...	16	50	1.40	0.60	0.46	3.3		
10-40UNS	4.0		40	4.0SIR40UN...	16	50	1.65	0.60	0.37	4.0	SMC..-4.0	
10-36UNS			36	4.0SIR36UN...	16	50	1.70	0.60	0.41	4.1		
12-32UNEF			32	4.0SIR32UN...	16	50	1.76	0.60	0.46	4.1		
12-28UNF			28	4.0SIR28UN...	16	50	1.83	0.65	0.52	4.2		
1/4"-27UNS	6.0		27	4.0SIR27UN...	16	50	1.85	0.75	0.54	4.2	SMC..-6.0	
12-24UNC			24	4.0SIR24UN...	16	50	1.93	0.75	0.61	4.3		
1/4"-20UNC			20	4.0SIR20UN...	16	50	2.03	0.76	0.73	4.3		
1/4"-32UNEF			32	6.0SIR32UN...	16	50	2.01	0.60	0.46	5.5		
5/16"-28UN	6.0		28	6.0SIR28UN...	16	50	2.08	0.65	0.52	5.6	SMC..-6.0	
5/16"-27UNS			27	6.0SIR27UN...	16	50	2.10	0.75	0.54	5.6		
5/16"-24UNF			24	6.0SIR24UN...	16	50	2.18	0.75	0.61	5.7		
5/16"-20UN			20	6.0SIR20UN...	16	50	2.30	0.90	0.73	5.8		
5/16"-18UNC	6.0		18	6.0SIR18UN...	16	50	2.39	1.00	0.81	5.9	SMC..-6.0	
3/8"-16UNC			16	6.0SIR16UN...	16	50	2.50	1.05	0.92	6.0		

LH Werkzeug lieferbar auf Anfrage. (Beispiel: 6.0SIL16UN...)

Micro - Einseitig



Gewinde	Einsatzdurchmesser		Teilung	Bestellnummer	Abmessungen mm					Min. Bohrungsdurchmesser		Klemmhalter
	d mm	mm			RH/LH	L1	L	F	Y	h min	mm	
8-32UNC	4.0		32	M429TH 32UN L16R/L	16	33	0.9	0.6	0.46	3.3	MHC..-4	
10-28UNS			28	M429TH 28UN L16R/L	16	33	0.9	0.65	0.52	3.6		
1/4"-27UNS	5.0		27	M549TH 27UN L16R/L	16	41	2.4	0.75	0.54	5.3	MHC..-5	
1/4"-24UNS			24	M542TH 24UN L16R/L	16	41	1.7	0.75	0.61	5.1		
1/4"-20UNC	6.0		20	M542TH 20UN L16R/L	16	41	1.7	0.9	0.73	4.6	MHC..-6	
5/16"-18UNC			18	M659TH 18UN L16R/L	16	42	2.9	1.05	0.81	6.3		
3/8"-16UNC			16	M659TH 16UN L16R/L	16	42	2.9	1.0	0.92	7.7		

LH Werkzeug lieferbar auf Anfrage. (Beispiel: M429TH 32UN L16L)

Whitworth - BSW, BSP(G), BSF, BSB

Aussen

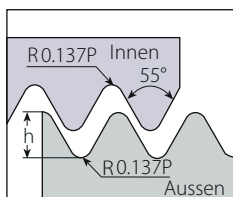

Norm: B.S.84:1956, DIN 259, ISO228/1:1982
Toleranzklasse: Medium class A

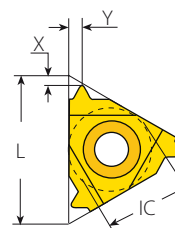

Standard

Standard

Plattengrösse		Teilung	Bestellnummer		Abmessungen mm			Unterlegplatte		Klemmhalter
IC	L mm	G/Z	RH	LH	h min	X	Y	RH	LH	
1/4"	11	72	2ER72W...	2EL72W...	0.23	0.7	0.4	-	-	NL...-2 (LH)
		60	2ER60W...	2EL60W...	0.27	0.7	0.4			
		56	2ER56W...	2EL56W...	0.29	0.7	0.4			
		48	2ER48W...	2EL48W...	0.34	0.6	0.6			
		40	2ER40W...	2EL40W...	0.41	0.6	0.6			
		36	2ER36W...	2EL36W...	0.45	0.6	0.6			
		32	2ER32W...	2EL32W...	0.51	0.6	0.6			
		28	2ER28W...	2EL28W...	0.58	0.6	0.7			
		26	2ER26W...	2EL26W...	0.63	0.7	0.8			
		24	2ER24W...	2EL24W...	0.68	0.7	0.8			
		22	2ER22W...	2EL22W...	0.74	0.8	0.9			
		20	2ER20W...	2EL20W...	0.81	0.8	0.9			
		19	2ER19W...	2EL19W...	0.86	0.8	1.0			
		18	2ER18W...	2EL18W...	0.90	0.8	1.0			
3/8"	16	72	3ER72W...	3EL72W...	0.23	0.7	0.4	YE3	YI3	AL...-3 (LH)
		60	3ER60W...	3EL60W...	0.27	0.7	0.4			
		56	3ER56W...	3EL56W...	0.29	0.7	0.4			
		48	3ER48W...	3EL48W...	0.34	0.6	0.6			
		40	3ER40W...	3EL40W...	0.41	0.6	0.6			
		36	3ER36W...	3EL36W...	0.45	0.6	0.6			
		32	3ER32W...	3EL32W...	0.51	0.6	0.6			
		30	3ER30W...	3EL30W...	0.55	0.6	0.7			
		28	3ER28W...	3EL28W...	0.58	0.6	0.7			
		26	3ER26W...	3EL26W...	0.63	0.7	0.8			
		24	3ER24W...	3EL24W...	0.68	0.7	0.8			
		22	3ER22W...	3EL22W...	0.74	0.8	0.9			
		20	3ER20W...	3EL20W...	0.81	0.8	0.9			
		19	3ER19W...	3EL19W...	0.86	0.8	1.0			
18	3ER18W...	3EL18W...	0.90	0.8	1.0					
16	3ER16W...	3EL16W...	1.02	0.9	1.1					
14	3ER14W...	3EL14W...	1.16	1.0	1.2					
12	3ER12W...	3EL12W...	1.36	1.1	1.4					
11	3ER11W...	3EL11W...	1.48	1.1	1.5					
10	3ER10W...	3EL10W...	1.63	1.1	1.5					
9	3ER9W...	3EL9W...	1.81	1.2	1.7					
8	3ER8W...	3EL8W...	2.03	1.2	1.5					



Whitworth - BSW, BSP(G), BSF, BSB (Fortsetzung)

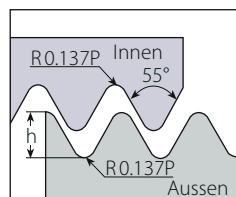

Aussen

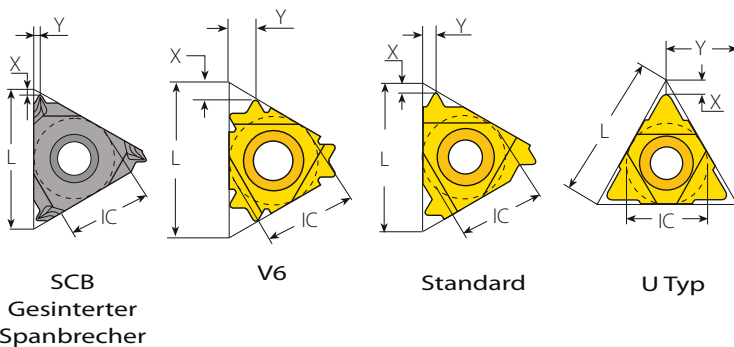

Norm: B.S.84:1956, DIN 259, ISO228/1:1982
Toleranzklasse: Medium class A



Standard (Fortsetzung)

Plattengrösse		Teilung	Bestellnummer		Abmessungen mm			Unterlegplatte		Klemmhalter	
IC	L mm	G/Z	RH	LH	h min	X	Y	RH	LH		
	3/8" SCB	16	36	3JER36W...		0.45	1.2	0.5	YE3	-	AL..-3
			32	3JER32W...		0.51	1.2	0.5			
			28	3JER28W...		0.58	0.7	0.8			
			24	3JER24W...		0.68	0.7	0.8			
			20	3JER20W...		0.81	0.7	0.8			
			19	3JER19W...		0.86	0.7	0.8			
			18	3JER18W...		0.90	0.8	0.8			
			16	3JER16W...		1.02	0.8	0.8			
			14	3JER14W...		1.16	1.3	1.5			
			12	3JER12W...		1.36	1.3	1.5			
			11	3JER11W...		1.48	1.3	1.5			
10	3JER10W...		1.63	1.3	1.5						
8	3JER8W...		2.03	1.3	1.5						
	3/8" V6	16	19	3ER19W-6C...		0.86	1.8	2.2	YE3-6C	-	AL..-3
			16	3ER16W-6C...		1.02	1.6	2.4			
			14	3ER14W-6C...		1.16	1.8	2.7			
	1/2"	22	7	4ER7W...	4EL7W...	2.41	1.6	2.3	YE4	YI4	AL..-4 (LH)
			6	4ER6W...	4EL6W...	2.71	1.6	2.3			
	5/8"	27	4.5	5ER4.5W...	5EL4.5W...	3.61	1.8	2.6	YE5	YI5	AL..-5 (LH)
			4	5ER4W...	5EL4W...	4.07	2.0	2.9			

U Typ

Plattengrösse		Teilung	Bestellnummer		Abmessungen mm			Unterlegplatte		Klemmhalter
IC	L mm	G/Z	RH+LH	h min	X	Y	RH	LH		
	1/2"U	22	4.5	4UEI4.5W...	3.61	2.3	11.0	YE4U	YI4U	AL..-4U (LH)
			4	4UEI4W...	4.07	1.8	11.0			
			3.5	4UEI3.5W...	4.65	2.1	11.0			
			3.25	4UEI3.25W...	5.00	2.0	11.0			
	5/8"U	27	3.5	5UEI3.5W...	4.65	2.1	13.7	YE5U	YI5U	AL..-5U (LH)
			3.25	5UEI3.25W...	5.00	2.0	13.7			
			3	5UEI3W...	5.42	2.3	13.7			
			2.75	5UEI2.75W...	5.91	2.4	13.7			

Whitworth - BSW, BSP(G), BSF, BSB (Fortsetzung)

Aussen

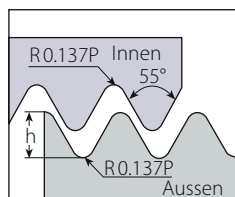

Norm: B.S.84:1956, DIN 259, ISO228/1:1982
Toleranzklasse: Medium class A

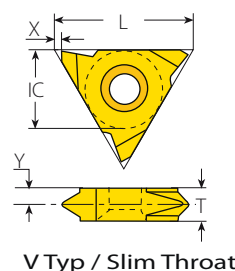

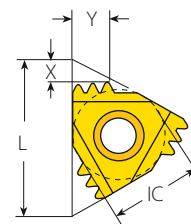

V Typ / Slim Throat



M+ Typ

Slim Throat

	Plattengrösse		Teilung	Bestellnummer		Abmessungen mm				Klemmhalter
	IC	L mm		RH	LH	h min	X	Y	T	
	1/4"V	11	19	2VER19W...	2VEL19W...	0.86	0.69	2.3	3.2	NL..-2V (LH)
			14	2VER14W...	2VEL14W...	1.16	0.69	2.0	3.2	
			11	2VER11W...	2VEL11W...	1.48	0.69	1.7	3.2	
	3/8"V	16	19	3VER19W...	3VEL19W...	0.86	1.1	2.7	3.6	NL..-3V (LH)
			18	3VER18W...	3VEL18W...	0.90	1.1	2.6	3.6	
			16	3VER16W...	3VEL16W...	1.02	1.1	2.6	3.6	
			14	3VER14W...	3VEL14W...	1.16	1.1	2.4	3.6	
			12	3VER12W...	3VEL12W...	1.36	1.1	2.2	3.6	
			11	3VER11W...	3VEL11W...	1.48	1.1	2.1	3.6	

V Typ

	Plattengrösse		Teilung	Bestellnummer		Abmessungen mm				Klemmhalter
	IC	L mm		RH	LH	h min	X	Y	T	
	5/8"V	27	4	5VER4W...	5VEL4W...	4.07	1.0	3.3	6	NL..-5V-6 (LH)
			3	5VER3W...	5VEL3W...	5.42	1.0	4.3	8	NL..-5V-8 (LH)
			2.5	5VER2.5W...	5VEL2.5W...	6.51	1.0	5.2	10	NL..-5V-10 (LH)

M+ Typ

	Plattengrösse		Teilung	Zähne	Bestellnummer		Abmessungen mm			Unterlegplatte	
	IC	L mm			RH	h min	X	Y	RH	Klemmhalter	
	3/8"	16	28	2	3ER28W2M+...	0.58	1.2	1.6	YE3M	AL..-3	
			19	2	3ER19W2M+...	0.86	1.6	2.3			
			19	3	3ER19W3M+...	0.86	2.2	3.4			
			14	2	3ER14W2M+...	1.16	2.0	3.0			
1/2"	22	14	3	4ER14W3M+...	1.16	2.9	4.6	YE4M	AL..-4		
		11	2	4ER11W2M+...	1.48	2.3	3.5				

Whitworth - BSW, BSP(G), BSF, BSB (Fortsetzung)

Innen

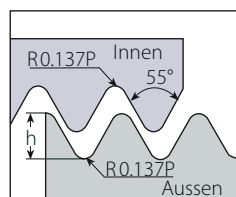

Norm: B.S.84:1956, DIN 259, ISO228/1:1982
Toleranzklasse: Medium class A

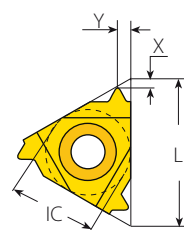

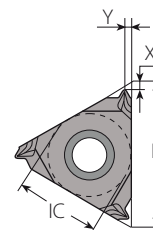

Standard



SCB
Gesintertes
Spanbrecher

Standard

Plattengröße		Teilung	Bestellnummer		Abmessungen mm			Unterlegplatte		Klemmhalter	
IC	L mm	G/Z	RH	LH	h min	X	Y	RH	LH		
	1/4"	11	72	2IR72W...	2IL72W...	0.23	0.7	0.4	-	-	NVR..-2 (LH)
			60	2IR60W...	2IL60W...	0.27	0.7	0.4			
			56	2IR56W...	2IL56W...	0.29	0.7	0.4			
			48	2IR48W...	2IL48W...	0.34	0.6	0.6			
			40	2IR40W...	2IL40W...	0.41	0.6	0.6			
			36	2IR36W...	2IL36W...	0.45	0.6	0.6			
			32	2IR32W...	2IL32W...	0.51	0.6	0.6			
			28	2IR28W...	2IL28W...	0.58	0.6	0.7			
			26	2IR26W...	2IL26W...	0.63	0.7	0.8			
			24	2IR24W...	2IL24W...	0.68	0.7	0.8			
			22	2IR22W...	2IL22W...	0.74	0.8	0.9			
			20	2IR20W...	2IL20W...	0.81	0.8	0.9			
			19	2IR19W...	2IL19W...	0.86	0.8	1.0			
			18	2IR18W...	2IL18W...	0.90	0.8	1.0			
16	2IR16W...	2IL16W...	1.02	0.9	1.1						
14	2IR14W...	2IL14W...	1.16	0.9	1.1						
12	2IR12W...	2IL12W...	1.32	0.9	1.2						
 SCB	1/4" SCB	11	36	2JIR36W...		0.45	1.2	0.5	-	-	NVR..-2
			32	2JIR32W...		0.51	1.2	0.5			
			28	2JIR28W...		0.58	0.7	0.8			
			24	2JIR24W...		0.68	0.7	0.8			
			20	2JIR20W...		0.81	0.7	0.8			
			19	2JIR19W...		0.86	0.6	0.8			
			18	2JIR18W...		0.90	0.8	0.8			
			16	2JIR16W...		1.02	0.8	0.8			
14	2JIR14W...		1.16	0.7	0.9						
	3/8"	16	72	3IR72W...	3IL72W...	0.23	0.7	0.4	Y13	YE3	AVR..-3 (LH)
			60	3IR60W...	3IL60W...	0.27	0.7	0.4			
			56	3IR56W...	3IL56W...	0.29	0.7	0.4			
			48	3IR48W...	3IL48W...	0.34	0.6	0.6			
			40	3IR40W...	3IL40W...	0.41	0.6	0.6			
			36	3IR36W...	3IL36W...	0.45	0.6	0.6			
			32	3IR32W...	3IL32W...	0.51	0.6	0.6			
			30	3IR30W...	3IL30W...	0.55	0.6	0.7			

Weiter Nächste Seite ▶

Whitworth - BSW, BSP(G), BSF, BSB (Fortsetzung)

Innen

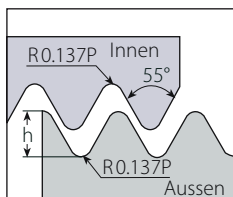

Norm: B.S.84:1956, DIN 259, ISO228/1:1982
Toleranzklasse: Medium class A

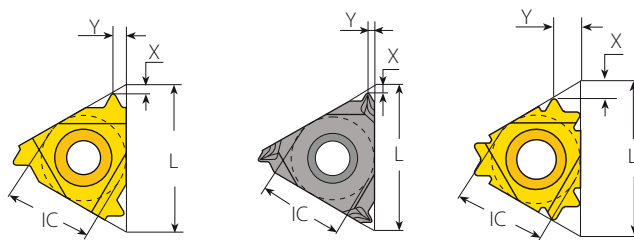





Standard

SCB
Gesinterter
Spanbrecher

V6

Standard (Fortsetzung)

Plattengröße		Teilung	Bestellnummer		Abmessungen mm			Unterlegplatte		Klemmhalter	
IC	L mm	G/Z	RH	LH	h min	X	Y	RH	LH		
	3/8"	16	28	3IR28W...	3IL28W...	0.58	0.6	0.7	Y13	YE3	AVR..-3 (LH)
			26	3IR26W...	3IL26W...	0.63	0.7	0.8			
			24	3IR24W...	3IL24W...	0.68	0.7	0.8			
			22	3IR22W...	3IL22W...	0.74	0.8	0.9			
			20	3IR20W...	3IL20W...	0.81	0.8	0.9			
			19	3IR19W...	3IL19W...	0.86	0.8	1.0			
			18	3IR18W...	3IL18W...	0.90	0.8	1.0			
			16	3IR16W...	3IL16W...	1.02	0.9	1.1			
			14	3IR14W...	3IL14W...	1.16	1.0	1.2			
			12	3IR12W...	3IL12W...	1.36	1.1	1.4			
			11	3IR11W...	3IL11W...	1.48	1.1	1.5			
			10	3IR10W...	3IL10W...	1.63	1.1	1.5			
9	3IR9W...	3IL9W...	1.81	1.2	1.7						
8	3IR8W...	3IL8W...	2.03	1.2	1.5						
	3/8" SCB	16	28	3JIR28W...		0.58	0.7	0.8	Y13	-	AVR...-3
			24	3JIR24W...		0.68	0.7	0.8			
			20	3JIR20W...		0.81	0.7	0.8			
			19	3JIR19W...		0.86	0.6	0.5			
			18	3JIR18W...		0.90	0.8	0.8			
			16	3JIR16W...		1.02	0.8	0.8			
			14	3JIR14W...		1.16	1.3	1.5			
			12	3JIR12W...		1.36	1.3	1.5			
	3/8" V6	16	19	3IR19W-6C...		0.86	1.7	2.2	Y13-6C	-	AVR..-3 NVRC..-3 206/...
			16	3IR16W-6C...		1.02	1.6	2.6			
			14	3IR14W-6C...		1.16	1.8	2.7			
			12	3IR12W-6C...		1.36	1.7	2.6			
	1/2"	22	7	4IR7W...	4IL7W...	2.41	1.6	2.3	Y14	YE4	AVR..-4 (LH)
			6	4IR6W...	4IL6W...	2.71	1.6	2.3			
			5	4IR5W...	4IL5W...	3.25	1.7	2.4			
	5/8"	27	4.5	5IR4.5W...	5IL4.5W...	3.61	1.8	2.6	Y15	YE5	AVR..-5 (LH)
			4	5IR4W...	5IL4W...	4.07	2.0	2.9			

Whitworth - BSW, BSP(G), BSF, BSB (Fortsetzung)

Innen

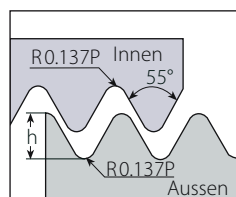

Norm: B.S.84:1956, DIN 259, ISO228/1:1982
Toleranzklasse: Medium class A

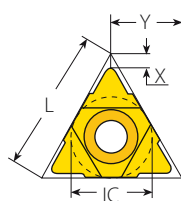

U Typ

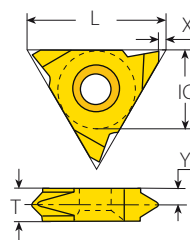

V Typ

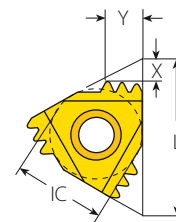

M+ Typ

U Typ



Plattengröße		Teilung	Bestellnummer		Abmessungen mm			Unterlegplatte		Klemmhalter
IC	L mm	G/Z	RH+LH	h min	X	Y	RH	LH		
1/2"U	22	4.5	4UEI4.5W...	3.61	2.3	11.0	Y14U	YE4U	AVR..-4U (LH)	
		4	4UEI4W...	4.07	1.8	11.0				
		3.5	4UEI3.5W...	4.65	2.1	11.0				
		3.25	4UEI3.25W...	5.00	2.0	11.0				
5/8"U	27	3.5	5UEI3.5W...	4.65	2.1	13.7	Y15U	YE5U	AVR..-5U (LH)	
		3.25	5UEI3.25W...	5.00	2.0	13.7				
		3	5UEI3W...	5.42	2.3	13.7				
		2.75	5UEI2.75W...	5.91	2.4	13.7				

V Typ



Plattengröße		Teilung	Bestellnummer		Abmessungen mm				Klemmhalter
IC	L mm	G/Z	RH	LH	h min	X	Y	T	
5/8"V	27	4	5VIR4W...	5VIL4W...	4.07	1.0	3.3	6	NVR..-5V (LH)
		3	5VIR3W...	5VIL3W...	5.42	1.0	4.3	8	
		2.5	5VIR2.5W...	5VIL2.5W...	6.51	1.0	5.2	10	

M+ Typ



Plattengröße		Teilung	Zähne	Bestellnummer	Abmessungen mm			Unterlegplatte	
IC	L mm	G/Z		RH	h min	X	Y	RH	Klemmhalter
3/8"	16	14	2	3IR14W2M+...	1.16	2.0	3.0	Y13M	AVR..-3
1/2"	22	11	2	4IR11W2M+...	1.48	2.3	3.5	Y14M	AVR..-4

Whitworth - BSW, BSP(G), BSF, BSB (Fortsetzung)



Innen

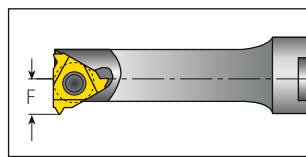
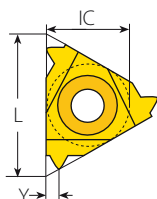
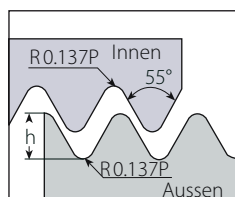

Mini3-Gewinde

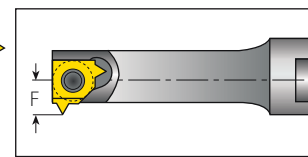
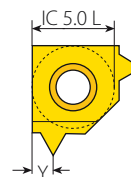

Mini-L-Gewinde

Norm: B.S.84:1956, DIN 259, ISO228/1:1982
Toleranzklasse: Medium class A

Mini-3 - Gewinde



Plattengrösse		Teilung	Bestellnummer	Abmessungen mm			Min. Bohrungsdurchmesser	Klemmhalter
IC	L mm	G/Z	RH	h min	Y	F	mm	
4.0	6	26	4.0KIR26W...	0.63	0.6	3.6	6.25	.NVR.5-4.0K
		22	4.0KIR22W...	0.74	0.6	3.7	6.35	
		20	4.0KIR20W...	0.81	0.7	3.7	6.35	
		19	4.0KIR19W...	0.86	0.7	3.7	6.35	
		18	4.0KIR18W...	0.90	0.7	3.7	6.35	
6.0	10	28	6.0IR28W...	0.58	0.7	4.7	9.6	.NVR1..-6.0
		19	6.0IR19W...	0.86	1.0	5.0	9.9	
		14	6.0IR14W...	1.16	1.1	5.3	10.0	

Mini-L - Gewinde



Plattengrösse		Teilung	Bestellnummer	Abmessungen mm			Min. Bohrungsdurchmesser	Klemmhalter
IC mm		G/Z	RH	h min	Y	F	mm	
5.0 L		28	5LIR28W...	0.58	0.7	4.05	7.6	.NVR 10. -5L
		19	5LIR19W...	0.86	1.0	4.35	7.9	
		14	5LIR14W...	1.16	1.1	4.68	8.0	

Whitworth - BSW, BSP(G), BSF, BSB (Fortsetzung)



Innen

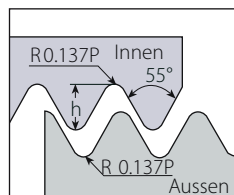

Norm: B.S.84:1956, DIN 259, ISO228/1:1982
Toleranzklasse: Medium class A

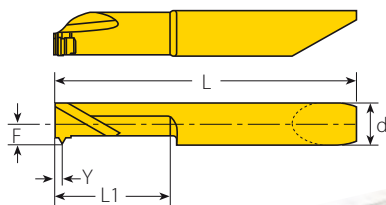

RH - Einseitig

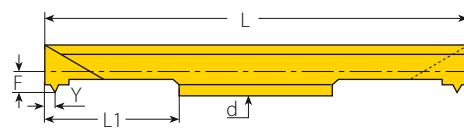

RH - Zweiseitig

Micro - Zweiseitig

Gewinde	Einsatzdurchmesser d mm	Teilung G/Z	Bestellnummer RH/LH	Abmessungen mm					Min. Bohrungsdurchmesser mm	Klemmhalter
				L1	L	F	Y	h min		
1/16"-28BSP	4.0	28	4.0SIR28W...	16	50	1.86	0.65	0.58	4.2	SMC...-4.0
1/4"-26BSF		26	4.0SIR26W...	16	50	1.93	0.75	0.63	4.2	
1/4"-24BSW		24	4.0SIR24W...	16	50	1.96	0.75	0.68	4.3	
1/16"-28BSP	6.0	28	6.0SIR28W...	16	50	2.50	0.65	0.58	6.0	SMC...-6.0
5/16"-28BSW		26	6.0SIR26W...	16	50	2.50	0.75	0.63	6.0	
5/16"-24BSW		24	6.0SIR24W...	16	50	2.50	0.75	0.68	6.0	
5/16"-22BSW		22	6.0SIR22W...	16	50	2.50	0.90	0.74	6.0	
3/8"-20BSF		20	6.0SIR20W...	16	50	2.50	0.90	0.81	6.0	
1/4"-19BSP	19	6.0SIR19W...	16	50	2.50	0.95	0.86	6.0		

LH Werkzeug lieferbar auf Anfrage. (Beispiel: 6.0SIL19W...)

Micro - Einseitig

microscope

Gewinde	Einsatzdurchmesser d mm	Teilung G/Z	Bestellnummer RH/LH	Abmessungen mm					Min. Bohrungsdurchmesser mm	Klemmhalter
				L1	L	F	Y	h min		
1/16"-28BSP	6.0	28	M659TH 28W L16R/L	16	42	2.90	0.65	0.58	6.5	MHC...-6
1/4"-19BSP		19	M659TH 19W L16R/L	16	42	2.90	0.95	0.86	11.4	

LH Werkzeug lieferbar auf Anfrage. (Beispiel: M659TH 28W L16L)

BSPT konisches Rohrgewinde

Aussen

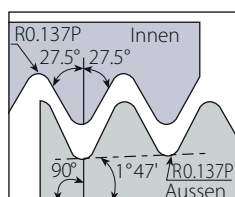

Norm: B.S. 21:1985
Toleranzklasse: DIN EN 10226-1

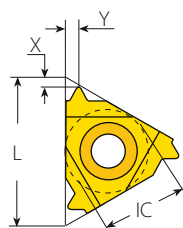

Standard

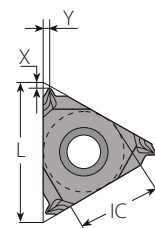

SCB
Gesinterter
Spanbrecher

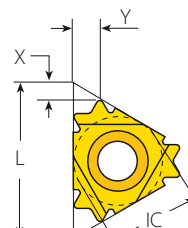

V6

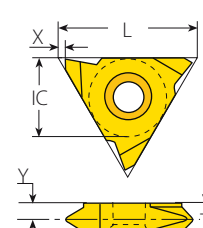

Slim Throat

Standard



SCB



V6

Plattengrösse		Teilung	Bestellnummer		Abmessungen mm			Unterlegplatte		Klemmhalter
IC	L mm	G/Z	RH	LH	h min	X	Y	RH	LH	
1/4"	11	28	2ER28BSPT...	2EL28BSPT...	0.58	0.6	0.6	-	-	NL...-2 (LH)
		19	2ER19BSPT...	2EL19BSPT...	0.86	0.8	0.9	-	-	
		14	2ER14BSPT...	2EL14BSPT...	1.16	0.9	1.0	-	-	
3/8"	16	28	3ER28BSPT...	3EL28BSPT...	0.58	0.6	0.6	YE3	YI3	AL...-3 (LH)
		19	3ER19BSPT...	3EL19BSPT...	0.86	0.8	0.9			
		14	3ER14BSPT...	3EL14BSPT...	1.16	1.0	1.2			
		11	3ER11BSPT...	3EL11BSPT...	1.48	1.1	1.5			
3/8" SCB	16	28	3JER28BSPT...		0.58	0.7	0.8	YE3	-	AL...-3
		19	3JER19BSPT...		0.86	0.7	0.8			
		14	3JER14BSPT...		1.16	1.3	1.5			
3/8" V6	16	19	3ER19BSPT-6C...		0.86	1.7	2.2	YE3-6C	-	AL...-3
		14	3ER14BSPT-6C...		1.16	1.9	2.8			

Slim Throat



Plattengrösse		Teilung	Bestellnummer		Abmessungen mm				Klemmhalter
IC	L mm	G/Z	RH	LH	h min	X	Y	T	
3/8"V	16	28	3VER28BSPT...	3VEL28BSPT...	0.58	1.1	3.0	3.6	NL...-3V (LH)
		19	3VER19BSPT...	3VEL19BSPT...	0.86	1.1	2.7	3.6	
		14	3VER14BSPT...	3VEL14BSPT...	1.16	1.1	2.4	3.6	
		11	3VER11BSPT...	3VEL11BSPT...	1.48	1.1	2.1	3.6	

BSPT (Fortsetzung)

Innen

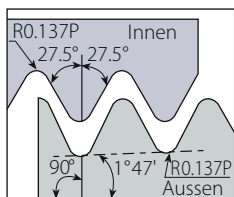

Norm: B.S. 21:1985
Toleranzklasse: DIN EN 10226-1

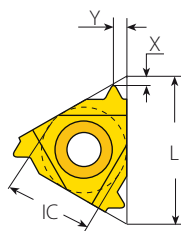

Standard

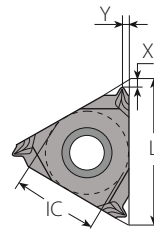

SCB
Gesinterter
Spanbrecher

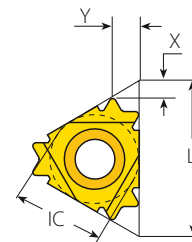

V6

Standard



SCB



V6

Plattengröße		Teilung	Bestellnummer		Abmessungen mm			Unterlegplatte		Klemmhalter
IC	L mm	G/Z	RH	LH	h min	X	Y	RH	LH	
1/4"	11	28	2IR28BSPT...	2IL28BSPT...	0.58	0.6	0.6	-	-	NVR..-2 (LH)
		19	2IR19BSPT...	2IL19BSPT...	0.86	0.8	0.9			
		14	2IR14BSPT...	2IL14BSPT...	1.16	0.9	1.0			
1/4" SCB	11	28	2JIR28BSPT...		0.58	0.7	0.8	-	-	NVR..-2
		19	2JIR19BSPT...		0.86	0.7	0.8			
3/8"	16	28	3IR28BSPT...	3IL28BSPT...	0.58	0.6	0.6	Y13	YE3	AVR..-3 (LH)
		19	3IR19BSPT...	3IL19BSPT...	0.86	0.8	0.9			
		14	3IR14BSPT...	3IL14BSPT...	1.16	1.0	1.2			
		11	3IR11BSPT...	3IL11BSPT...	1.48	1.1	1.5			
3/8" SCB	16	28	3JIR28BSPT...		0.58	0.7	0.8	Y13	-	AVR..-3
		19	3JIR19BSPT...		0.86	0.7	0.8			
		14	3JIR14BSPT...		1.16	1.3	1.5			
		11	3JIR11BSPT...		1.48	1.3	1.5			
3/8" V6	16	19	3IR19BSPT-6C...		0.86	1.8	2.3	Y13-6C	-	AVR..-3 NVRC..-3 206/..
		14	3IR14BSPT-6C...		1.16	1.9	2.7			

Innen

Norm: B.S. 21:1985
Toleranzklasse: DIN EN 10226-1

Mini-3 - Gewinde



Plattengröße		Teilung	Bestellnummer	Abmessungen mm			Min. Bohrungsdurchmesser	
IC	L mm	G/Z	RH	h min	Y	F	mm	Klemmhalter
4.0	6	28	4.0KIR28BSPT...	0.58	0.6	3.6	6.25	.NVR.5-4.0K
		28	6.0IR28BSPT...	0.58	0.6	4.7	9.6	
6.0	10	19	6.0IR19BSPT...	0.86	0.9	5.0	9.9	.NVR1...-6.0
		14	6.0IR14BSPT...	1.16	1.2	5.3	10.0	

Mini-L - Gewinde



Plattengröße		Teilung	Bestellnummer	Abmessungen mm			Min. Bohrungsdurchmesser	
IC mm		G/Z	RH	h min	Y	F	mm	Klemmhalter
5.0L		28	5LIR28BSPT...	0.58	0.6	4.05	7.6	
		19	5LIR19BSPT...	0.86	0.9	4.35	7.9	.NVR10. -5L
		14	5LIR14BSPT...	1.16	1.2	4.68	8.0	

NPT

Aussen

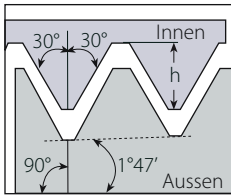

Norm: USAS B2.1:1968
Toleranzklasse: Standard NPT

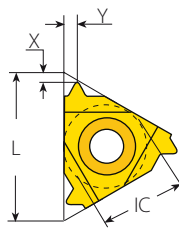

Standard

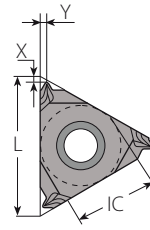

SCB
Gesinterter
Spanbrecher

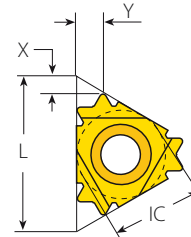

V6

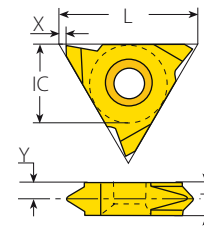

Slim Throat

Standard

IC	L mm	Teilung G/Z	Bestellnummer		Abmessungen mm			Unterlegplatte		
			RH	LH	h min	X	Y	RH	LH	Klemmhalter
1/4"	11	27	2ER27NPT...	2EL27NPT...	0.66	0.7	0.8	-	-	NL...-2 (LH)
		18	2ER18NPT...	2EL18NPT...	1.01	0.8	1.0	-	-	
		14	2ER14NPT...	2EL14NPT...	1.33	0.8	1.0	-	-	
3/8"	16	27	3ER27NPT...	3EL27NPT...	0.66	0.7	0.8	YE3	YI3	AL...-3 (LH)
		18	3ER18NPT...	3EL18NPT...	1.01	0.8	1.0			
		14	3ER14NPT...	3EL14NPT...	1.33	0.9	1.2			
		11.5	3ER11.5NPT...	3EL11.5NPT...	1.64	1.1	1.5			
3/8" SCB	16	27	3JER27NPT...		0.66	0.6	0.8	YE3	-	AL...-3
		18	3JER18NPT...		1.01	0.6	0.8			
		14	3JER14NPT...		1.33	1.1	1.5			
		11.5	3JER11.5NPT...		1.64	1.1	1.5			
3/8" V6	16	14	3ER14NPT-6C...		1.33	1.9	3.0	YE3-6C	-	AL...-3



SCB



V6

Slim Throat

IC	L mm	Teilung G/Z	Bestellnummer		Abmessungen mm				Klemmhalter
			RH	LH	h min	X	Y	T	
1/4"V	11	27	2VER27NPT...	2VEL27NPT...	0.66	0.7	2.0	3.2	NL...-2V (LH)
		18	2VER18NPT...	2VEL18NPT...	1.01	0.7	1.8	3.2	
		14	2VER14NPT...	2VEL14NPT...	1.33	0.7	1.8	3.2	
		11.5	2VER11.5NPT...	2VEL11.5NPT...	1.64	0.7	2.1	3.2	
3/8"V	16	27	3VER27NPT...	3VEL27NPT...	0.66	1.1	2.9	3.6	NL...-3V (LH)
		18	3VER18NPT...	3VEL18NPT...	1.01	1.1	2.6	3.6	
		11.5	3VER11.5NPT...	3VEL11.5 NPT...	1.64	1.1	2.1	3.6	



NPT (Fortsetzung)

Aussen

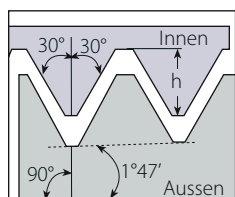

Norm: USAS B2.1:1968
Toleranzklasse: Standard NPT

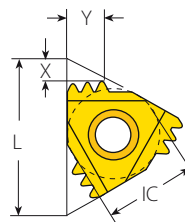

M+ Typ

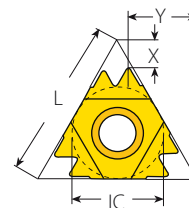

Z+ Typ

M+ Typ

Multiplus



Plattengrösse		Teilung	Zähne	Bestellnummer	Abmessungen mm			Unterlegplatte	
IC	L mm	G/Z	RH		h min	X	Y	RH	Klemmhalter
3/8"	16	14	2	3ER14NPT2M+...	1.33	2.0	3.0	YE3M	AL..-3
1/2"	22	11.5	2	4ER11.5NPT2M+...	1.64	2.2	3.4	YE4M	AL..-4
5/8"	27	11.5	3	5ER11.5NPT3M+...	1.64	3.5	5.6	YE5M	AL..-5M
		8	2	5ER8NPT2M+...	2.42	3.1	4.9		

Z+ Typ

Multiplus



Plattengrösse		Teilung	Zähne	Bestellnummer	Abmessungen mm			Unterlegplatte	
IC	L mm	G/Z	RH		h min	X	Y	RH	Klemmhalter
1/2"	22	11.5	2	4ER11.5NPT2Z+...	1.64	2.7	10.0	YE4Z	AL..-4Z
		8	2	4ER8NPT2Z+...	2.42	3.4	9.6		

NPT (Fortsetzung)

Innen

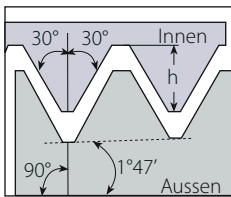

Norm: USAS B2.1:1968
Toleranzklasse: Standard NPT

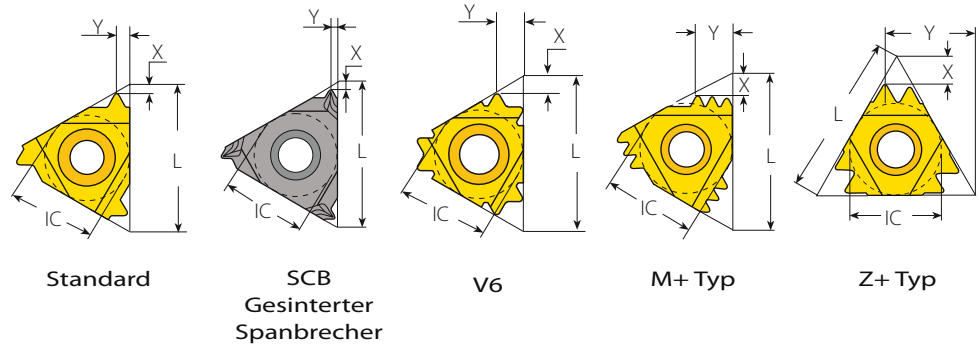

Standard

IC	L mm	Teilung G/Z	Bestellnummer		Abmessungen mm			Unterlegplatte		Klemmhalter
			RH	LH	h min	X	Y	RH	LH	
1/4"	11	27	2IR27NPT...	2IL27NPT...	0.66	0.7	0.8	-	-	NVR..-2 (LH)
		18	2IR18NPT...	2IL18NPT...	1.01	0.8	1.0	-	-	
		14	2IR14NPT...	2IL14NPT...	1.33	0.8	1.0	-	-	
1/4" SCB	11	27	2JIR27NPT...		0.66	0.6	0.8	-	-	NVR..-2
		18	2JIR18NPT...		1.01	0.6	0.8	-	-	
		14	2JIR14NPT...		1.33	0.6	0.8	-	-	
3/8"	16	27	3IR27NPT...	3IL27NPT...	0.66	0.7	0.8	Y13	YE3	AVR..-3 (LH)
		18	3IR18NPT...	3IL18NPT...	1.01	0.8	1.0			
		14	3IR14NPT...	3IL14NPT...	1.33	0.9	1.2			
		11.5	3IR11.5NPT...	3IL11.5NPT...	1.64	1.1	1.5			
3/8" SCB	16	27	3JIR27NPT...		0.66	0.6	0.8	Y13	-	AVR..-3
		18	3JIR18NPT...		1.01	0.6	0.8			
		14	3JIR14NPT...		1.33	1.1	1.5			
		11.5	3JIR11.5NPT...		1.64	1.1	1.5			
3/8" V6	16	14	3IR14NPT-6C...		1.33	1.9	2.8	Y13-6C	-	AVR..-3 NVRC..-3 206/...

M+ Typ



IC	L mm	Teilung G/Z	Zähne	Bestellnummer		Abmessungen mm			Unterlegplatte	
				RH	LH	h min	X	Y	RH	LH
3/8"	16	14	2	3IR14NPT2M+...		1.33	2.0	3.0	Y13M	AVR..-3
1/2"	22	11.5	2	4IR11.5NPT2M+...		1.64	2.2	3.4	Y14M	AVR..-4
				5IR11.5NPT3M+...		1.64	3.5	5.6	Y15M	AVR..-5M
5/8"	27	11.5	3	5IR11.5NPT3M+...		1.64	3.5	5.6		
				8	2	5IR8NPT2M+...		2.42	3.1	4.9

Z+ Typ



IC	L mm	Teilung G/Z	Zähne	Bestellnummer		Abmessungen mm			Unterlegplatte	
				RH	LH	h min	X	Y	RH	LH
1/2"	22	11.5	2	4IR11.5NPT2Z+...		1.64	2.7	10.0	Y14Z	AVR..-4Z
				8	2	4IR8NPT2Z+...		2.42		

NPT (Fortsetzung)



Innen

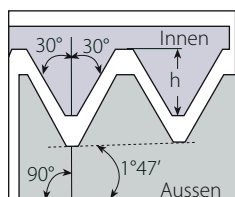

Norm: USAS B2.1:1968
Toleranzklasse: Standard NPT

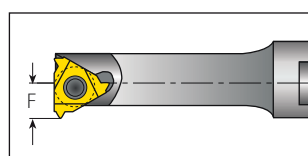
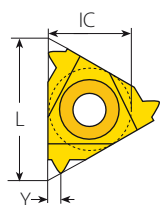

Mini3-Gewinde

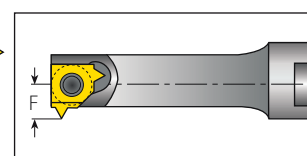
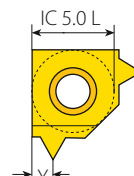

Mini-L-Gewinde

Mini-3 - Gewinde



Plattengröße		Teilung	Bestellnummer	Abmessungen mm			Min. Bohrungsdurchmesser	
IC	L mm	G/Z	RH	h min	Y	F	mm	Klemmhalter
4.0	6.0	27	4.0KIR27NPT...	0.66	0.6	3.7	6.35	.NVR.5-4.0K
		27	6.0IR27NPT...	0.66	0.8	5.3		
6.0	10	18	6.0IR18NPT...	1.01	1.0	5.3	10.0	.NVR1.-6.0
		14	6.0IR14NPT...	1.33	1.1	5.3		

Mini-L - Gewinde



Plattengröße		Teilung	Bestellnummer	Abmessungen mm			Min. Bohrungsdurchmesser	
IC mm		G/Z	RH	h min	Y	F	mm	Klemmhalter
5.0L		27	5LIR27NPT...	0.66	0.8	4.65	8.0	.NVR10.-5L
		18	5LIR18NPT...	1.01	1.0	4.65		
		14	5LIR14NPT...	1.33	1.1	4.65		

NPT

Innen

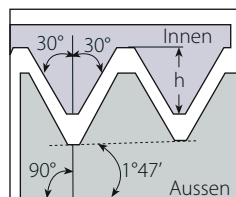

Norm: USAS B2.1:1968
Toleranzklasse: Standard NPT

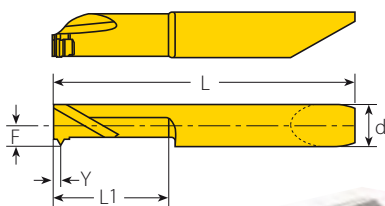

RH - Einseitig

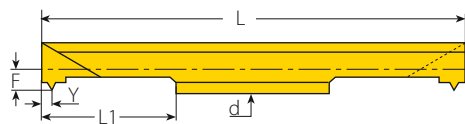

RH - Zweiseitig

Micro - Zweiseitig

Gewinde	Einsatzdurchmesser		Teilung	Bestellnummer	Abmessungen mm					Min. Bohrungsdurchmesser	Klemmhalter
	d mm	mm			RH/LH	L1	L	F	Y		
1/16"-27NPT	6.0	27	6.0SIR27NPT...	16	50	2.50	1.00	0.66	5.9	SMC..-6.0	
1/4"-18NPT											18

LH Werkzeug lieferbar auf Anfrage. (Beispiel: 6.0SIL18NPT...)

Micro - Einseitig

Gewinde	Einsatzdurchmesser		Teilung	Bestellnummer	Abmessungen mm					Min. Bohrungsdurchmesser	Klemmhalter
	d mm	mm			RH/LH	L1	L	F	Y		
1/16"-27NPT	6.0	27	M659TH 27NPT L16R/L	16	42	2.90	0.75	0.66	6.1	MHC..-6	
1/4"-18NPT											18

LH Werkzeug lieferbar auf Anfrage. (Beispiel: M659TH 27NPT L16L)

NPTF

Aussen

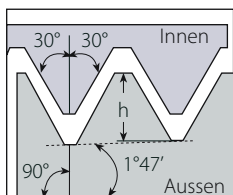

Norm: ANSI B1.20.3-1976
Toleranzklasse: Class 2

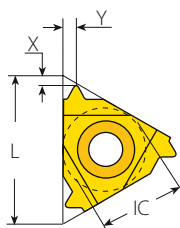

Standard

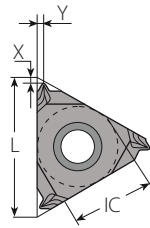

SCB
Gesinterter
Spanbrecher

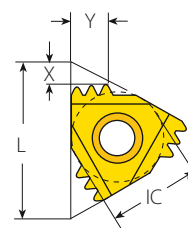

M+ Typ

Standard



SCB

Plattengrösse		Teilung	Bestellnummer		Abmessungen mm			Unterlegplatte		
IC	L mm	G/Z	RH	LH	h min	X	Y	RH	LH	Klemmhalter
1/4"	11	27	2ER27NPTF...	2EL27NPTF...	0.64	0.7	0.8	-	-	NL..-2 (LH)
		18	2ER18NPTF...	2EL18NPTF...	1.00	0.8	1.0	-	-	
		14	2ER14NPTF...	2EL14NPTF...	1.35	0.8	1.0	-	-	
3/8"	16	27	3ER27NPTF...	3EL27NPTF...	0.64	0.7	0.8	-	-	
		18	3ER18NPTF...	3EL18NPTF...	1.00	0.8	1.0	-	-	
		14	3ER14NPTF...	3EL14NPTF...	1.35	0.9	1.2	YE3	YI3	AL..-3 (LH)
		11.5	3ER11.5NPTF...	3EL11.5NPTF...	1.63	1.1	1.5	-	-	
3/8" SCB	16	8	3ER8NPTF...	3EL8NPTF...	2.38	1.3	1.8	-	-	
		27	3JER27NPTF...		0.64	0.7	0.8	-	-	
		18	3JER18NPTF...		1.00	0.6	0.8	-	-	
		14	3JER14NPTF...		1.35	1.1	1.5	YE3	-	AL..-3
		11.5	3JER11.5NPTF...		1.63	1.1	1.5	-	-	
		8	3JER8NPTF		2.38	1.1	1.5	-	-	

M+ Typ



Plattengrösse		Teilung	Zähne	Bestellnummer	Abmessungen mm			Unterlegplatte	
IC	L mm	G/Z		RH	h min	X	Y	RH	Klemmhalter
3/8"	16	14	2	3ER14NPTF2M+...	1.35	2.0	3.0	YE3M	AL...-3

Multiplus

NPTF (Fortsetzung)

Innen

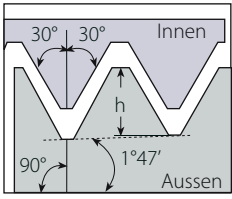

Norm: ANSI B1.20.3-1976
Toleranzklasse: Class 2

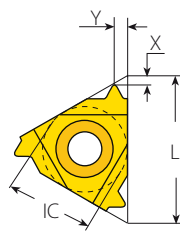

Standard

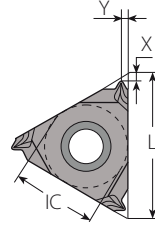

SCB
Gesinterter
Spanbrecher

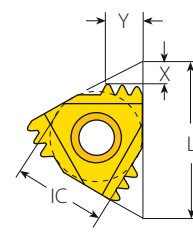

M+ Typ

Standard

Plattengrösse		Teilung	Bestellnummer		Abmessungen mm			Unterlegplatte		Klemmhalter	
IC	L mm	G/Z	RH	LH	h min	X	Y	RH	LH		
	1/4"	11	27	2IR27NPTF...	2IL27NPTF...	0.64	0.7	0.8	-	-	NVR..-2 (LH)
			18	2IR18NPTF...	2IL18NPTF...	1.00	0.8	1.0			
			14	2IR14NPTF...	2IL14NPTF...	1.35	0.8	1.0			
1/4" SCB	11	27	2JIR27NPTF...		0.64	0.7	0.8	-	-	NVR..-2	
		18	2JIR18NPTF...		1.00	0.6	0.8				
3/8"	16	27	3IR27NPTF...	3IL27NPTF...	0.64	0.7	0.8	YI3	YE3	AVR..-3 (LH)	
		18	3IR18NPTF...	3IL18NPTF...	1.00	0.8	1.0				
		14	3IR14NPTF...	3IL14NPTF...	1.35	0.9	1.2				
		11.5	3IR11.5NPTF...	3IL11.5NPTF...	1.63	1.1	1.5				
		8	3IR8NPTF...	3IL8NPTF...	2.38	1.3	1.8				
3/8" SCB	16	27	3JIR27NPTF...		0.64	0.7	0.8	YI3	-	AVR..-3	
		18	3JIR18NPTF...		1.00	0.6	0.8				
		14	3JIR14NPTF...		1.35	1.1	1.5				
		11.5	3JIR11.5NPTF...		1.63	1.1	1.5				
		8	3JIR8NPTF...		2.38	1.1	1.5				

SCB

M+ Typ

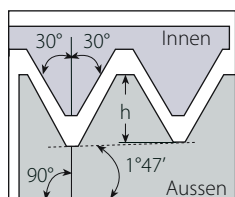

Plattengrösse		Teilung	Zähne	Bestellnummer	Abmessungen mm			Unterlegplatte	
IC	L mm	G/Z		RH	h min	X	Y	RH	Klemmhalter
3/8"	16	14	2	3IR14NPTF2M+...	1.35	2.0	3.0	YI3M	AVR..-3

NPTF (Fortsetzung)**Innen**

Norm: ANSI B1.20.3-1976
Toleranzklasse: Class 2

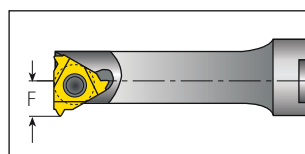
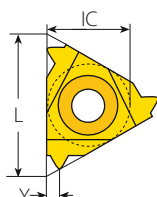
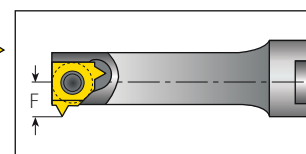
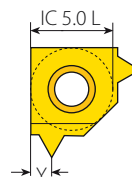
**Mini3-Gewinde****Mini-L-Gewinde****Mini-3 - Gewinde**

Plattengrösse		Teilung	Bestellnummer	Abmessungen mm			Min. Bohrungsdurchmesser	Klemmhalter
IC	L mm	G/Z	RH	h min	Y	F	mm	
4.0	6	27	4.0KIR27NPTF...	0.64	0.6	3.6	6.25	.NVR.5-4.0K
		27	6.0IR27NPTF...	0.64	0.8	5.3		
6.0	10	18	6.0IR18NPTF...	1.00	1.0	5.3	10.0	.NVR1...-6.0
		14	6.0IR14NPTF...	1.35	1.1	5.3		

Mini-L - Gewinde

Plattengrösse		Teilung	Bestellnummer	Abmessungen mm			Min. Bohrungsdurchmesser	Klemmhalter
IC mm		G/Z	RH	h min	Y	F	mm	
5.0L		27	5LIR27NPTF...	0.64	0.8	4.65	8.0	.NVR 10. -5L
		18	5LIR18NPTF...	1.00	1.0	4.65		
		14	5LIR14NPTF...	1.35	1.1	4.65		

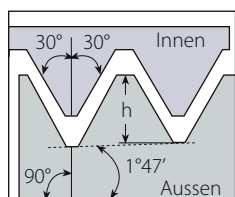
NPTF**Innen**

Norm: ANSI B1.20.3-1976
Toleranzklasse: Class 2

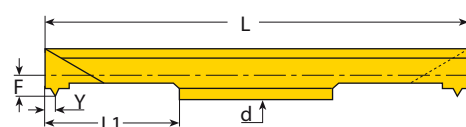
**RH - Zweiseitig****Micro - Zweiseitig**

Einsatzdurchmesser		Teilung	Bestellnummer	Abmessungen mm					Min. Bohrungsdurchmesser	Klemmhalter
Gewinde	d mm	G/Z	RH/LH	L1	L	F	Y	h min	mm	
1/16"-27NPTF	6.0	27	6.0SIR27NPTF...	16	50	2.50	0.80	0.64	6.0	SMC...-6.0
1/4"-18NPTF		18	6.0SIR18NPTF...	16	50	2.50	1.00	1.00		

LH Werkzeug lieferbar auf Anfrage. (Beispiel: 6.0SIL18NPTF...)

NPS

Aussen / Innen

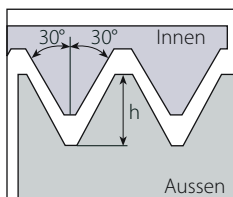

Norm: USA NBS H28 (1957)
Toleranzklasse: Standard NPS

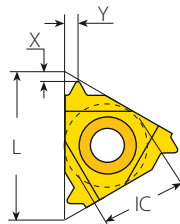

Aussen - Norm

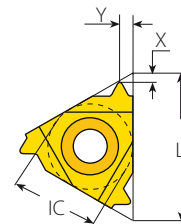

Innen - Norm

Aussen

Standard



Plattengrösse		Teilung	Bestellnummer		Abmessungen mm			Unterlegplatte		Klemmhalter
IC	L mm		G/Z	RH	LH	h min	X	Y	RH	
3/8"	16	24	3ER24NPS...	3EL24NPS...	0.79	0.7	0.8	YE3	YI3	AL...-3 (LH)
		16	3ER16NPS...	3EL16NPS...	1.21	0.8	1.1			
		14	3ER14NPS...	3EL14NPS...	1.33	0.9	1.2			
		12	3ER12NPS...	3EL12NPS...	1.63	1.1	1.4			
		11.5	3ER11.5NPS...	3EL11.5NPS...	1.71	1.1	1.5			
1/2"	22	8	4ER8NPS...	4EL8NPS...	2.46	1.3	1.9	YE4	YI4	AL...-4 (LH)
		7	4ER7NPS...	4EL7NPS...	2.82	1.6	2.3			
		6	4ER6NPS...	4EL6NPS...	3.31	1.6	2.3			
5/8"	27	5	5ER5NPS...	5EL5NPS...	3.98	1.9	2.8	YE5	YI5	AL...-5 (LH)

Innen

Standard



Plattengrösse		Teilung	Bestellnummer		Abmessungen mm			Unterlegplatte		Klemmhalter
IC	L mm		G/Z	RH	LH	h min	X	Y	RH	
3/8"	16	24	3IR24NPS...	3IL24NPS...	0.79	0.7	0.8	YI3	YE3	AVR...-3 (LH)
		14	3IR14NPS...	3IL14NPS...	1.33	0.9	1.2			
		12	3IR12NPS...	3IL12NPS...	1.63	1.1	1.4			
		11.5	3IR11.5NPS...	3IL11.5NPS...	1.71	1.1	1.5			
1/2"	22	8	4IR8NPS...	4IL8NPS...	2.46	1.3	1.9	YI4	YE4	AVR...-4 (LH)
		7	4IR7NPS...	4IL7NPS...	2.82	1.6	2.3			
		6	4IR6NPS...	4IL6NPS...	3.31	1.6	2.3			
5/8"	27	5	5IR5NPS...	5IL5NPS...	3.98	1.9	2.8	YI5	YE5	AVR...-5 (LH)

Rund (DIN 405)

Aussen

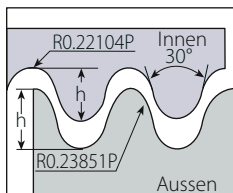

Norm: DIN 405
Toleranzklasse: 7h/7H

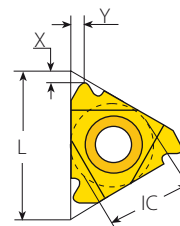

Standard

Standard



Plattengrösse		Teilung	Bestellnummer		Abmessungen mm			Unterlegplatte		Klemmhalter
IC	L mm	G/Z	RH	LH	h min	X	Y	RH	LH	
3/8"	16	10	3ER10RD...	3EL10RD...	1.27	1.1	1.2	YE3	YI3	AL..-3 (LH)
		8	3ER8RD...	3EL8RD...	1.59	1.4	1.3			
		6	3ER6RD...	3EL6RD...	2.12	1.5	1.7			
1/2"	22	6	4ER6RD...	4EL6RD...	2.12	1.5	1.7	YE4	YI4	AL..-4 (LH)
		4	4ER4RD...	4EL4RD...	3.18	2.2	2.3			
5/8"	27	4	5ER4RD...	5EL4RD...	3.18	2.2	2.3	YE5	YI5	AL..-5 (LH)

Innen

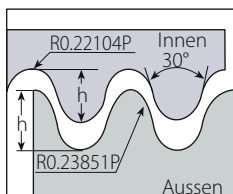

Norm: DIN 405
Toleranzklasse: 7h/7H

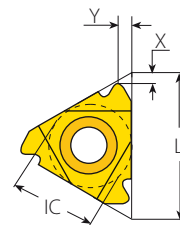

Standard

Standard



Plattengrösse		Teilung	Bestellnummer		Abmessungen mm			Unterlegplatte		Klemmhalter
IC	L mm	G/Z	RH	LH	h min	X	Y	RH	LH	
3/8"	16	10	3IR10RD...	3IL10RD...	1.27	1.1	1.2	YI3	YE3	AVR..-3 (LH)
		8	3IR8RD...	3IL8RD...	1.59	1.4	1.4			
		6	3IR6RD...	3IL6RD...	2.12	1.4	1.5			
1/2"	22	6	4IR6RD...	4IL6RD...	2.12	1.5	1.7	YI4	YE4	AVR..-4 (LH)
		4	4IR4RD...	4IL4RD...	3.18	2.2	2.3			
5/8"	27	4	5IR4RD...	5IL4RD...	3.18	2.2	2.3	YI5	YE5	AVR..-5 (LH)

Rund (DIN 20400)

Aussen

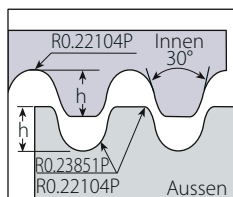

Norm: DIN 20400
Toleranzklasse: Standard

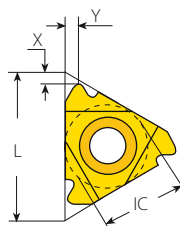

Standard

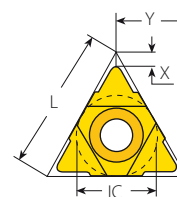

U Typ

Standard



Plattengrösse		Teilung	Bestellnummer		Abmessungen mm			Unterlegplatte		Klemmhalter
IC	L mm	mm	RH	LH	h min	X	Y	RH	LH	
1/2"	22	3.0	4ER3.0RD20400...	4EL3.0RD20400...	1.65	1.3	1.7	YE4	YI4	AL..-4 (LH)
		4.0	4ER4.0RD20400...	4EL4.0RD20400...	2.20	1.6	2.2			
		5.0	4ER5.0RD20400...	4EL5.0RD20400...	2.75	1.4	1.7			
		6.0	4ER6.0RD20400...	4EL6.0RD20400...	3.30	1.7	2.1			

U Typ



Plattengrösse		Teilung	Bestellnummer	Abmessungen mm			Unterlegplatte		Klemmhalter
IC	L mm	mm	RH+LH	h min	X	Y	RH	LH	
5/8"U	27	8.0	5UEI8.0RD20400...	4.4	2.9	13.5	YE5U	YI5U	AL..-5U (LH)

Rund (DIN 20400)

Innen

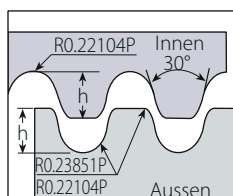

Norm: DIN 20400
Toleranzklasse: Standard

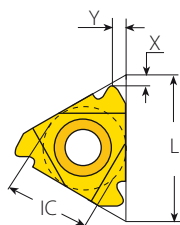

Standard

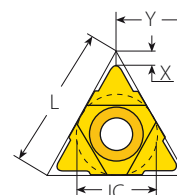

U Typ

Standard



Plattengrösse		Teilung	Bestellnummer		Abmessungen mm			Unterlegplatte		Klemmhalter
IC	L mm	mm	RH	LH	h min	X	Y	RH	LH	
1/2"	22	3.0	4IR3.0RD20400...	4IL3.0RD20400...	1.65	1.3	1.7	YI4	YE4	AVR..-4 (LH)
		4.0	4IR4.0RD20400...	4IL4.0RD20400...	2.20	1.6	2.2			
		5.0	4IR5.0RD20400...	4IL5.0RD20400...	2.75	1.4	1.7			
		6.0	4IR6.0RD20400...	4IL6.0RD20400...	3.30	1.7	2.1			

U Typ



Plattengrösse		Teilung	Bestellnummer	Abmessungen mm			Unterlegplatte		Klemmhalter
IC	L mm	mm	RH+LH	h min	X	Y	RH	LH	
5/8"U	27	8.0	5UEI8.0RD20400...	4.4	2.9	13.5	YI5U	YE5U	AVR..-5U (LH)

Trapez

Aussen

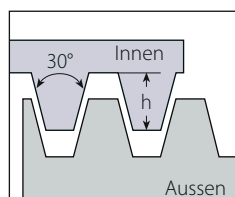

Norm: DIN 103
Toleranzklasse: 7e/7H

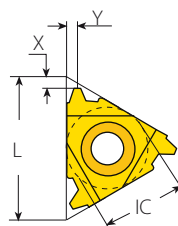

Standard

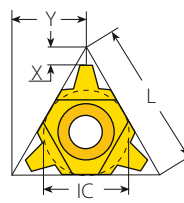

U Typ

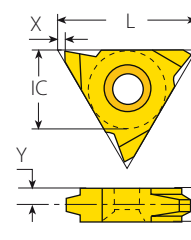

V Typ

Standard



Plattengrösse		Teilung	Bestellnummer		Abmessungen mm			Unterlegplatte		
IC	L mm	mm	RH	LH	h min	X	Y	RH	LH	Klemmhalter
1/4"	11	1.5	2ER1.5TR...	2EL1.5TR...	0.90	0.8	0.9	-	-	NL..-2 (LH)
		1.5	3ER1.5TR...	3EL1.5TR...	0.90	1.0	1.1	-	-	-
3/8"	16	2.0	3ER2.0TR...	3EL2.0TR...	1.25	1.1	1.3	YE3	YI3	AL..-3 (LH)
		2.5	3ER2.5TR...	3EL2.5TR...	1.55	1.2	1.4			
		3.0	3ER3.0TR...	3EL3.0TR...	1.75	1.3	1.5			
		4.0	4ER4.0TR...	4EL4.0TR...	2.25	1.7	1.9			
1/2"	22	5.0	4ER5.0TR...	4EL5.0TR...	2.75	2.1	2.5	YE4	YI4	AL..-4 (LH)
		6.0	4ER6.0TR...	4EL6.0TR...	3.50	2.3	2.7			
5/8"	27	6.0	5ER6.0TR...	5EL6.0TR...	3.50	2.3	2.7	YE5	YI5	AL..-5 (LH)

U Typ



Plattengrösse		Teilung	Bestellnummer		Abmessungen mm			Unterlegplatte		
IC	L mm	mm	RH+LH		h min	X	Y	RH	LH	Klemmhalter
1/2"U	22	6.0	4UE6.0TR...		3.50	2.0	11.0	YE4U	YI4U	AL..-4U (LH)
		7.0	4UE7.0TR...		4.00	2.3	11.0			
		8.0	4UE8.0TR...		4.50	2.6	11.0			
5/8"U	27	8.0	5UE8.0TR...		4.50	2.6	13.7	YE5U	YI5U	AL..-5U (LH)
		9.0	5UE9.0TR...		5.00	3.0	13.7			

V Typ



Plattengrösse		Teilung	Bestellnummer		Abmessungen mm				Klemmhalter
IC	L mm	mm	RH	LH	h min	X	Y	T	Klemmhalter
5/8"V	27	6.0	5VER6.0TR...	5VEL6.0TR...	3.50	1.0	3.3	6	NL..-5V-6 (LH)
		7.0	5VER7.0TR...	5VEL7.0TR...	4.00	1.0	3.3	6	
		8.0	5VER8.0TR...	5VEL8.0TR...	4.50	1.0	3.3	6	NL..-5V-8 (LH)
		9.0	5VER9.0TR...	5VEL9.0TR...	5.00	1.0	4.3	8	
		10.0	5VER10.0TR...	5VEL10.0TR...	5.50	1.0	4.3	8	
		12.0	5VER12.0TR...	5VEL12.0TR...	6.50	1.0	5.2	10	

Trapez (Fortsetzung)

Innen

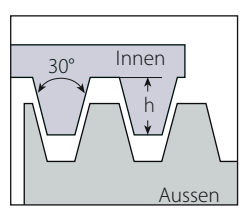

Norm: DIN 103
Toleranzklasse: 7e/7H

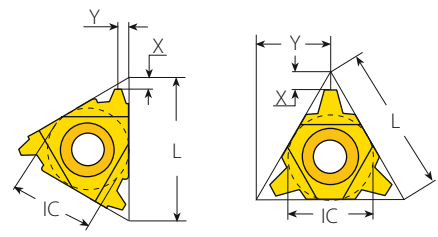

Standard

U Typ

Standard



IC	L mm	Teilung mm	Bestellnummer		Abmessungen mm			Unterlegplatte		Klemmhalter
			RH	LH	h min	X	Y	RH	LH	
1/4"	11	1.5	2IR1.5TR...	2IL1.5TR...	0.90	0.8	0.9	-	-	NVR 8-2 (LH)
3/8"	16	1.5	3IR1.5TR...	3IL1.5TR...	0.90	1.0	1.1	YI3	YE3	AVR..-3 (LH)
		2.0	3IR2.0TR...	3IL2.0TR...	1.25	1.1	1.3			
		2.5	3IR2.5TR...	3IL2.5TR...	1.53	1.2	1.4			
		3.0	3IR3.0TR...	3IL3.0TR...	1.75	1.3	1.5			
1/2"	22	4.0	4IR4.0TR...	4IL4.0TR...	2.25	1.7	1.9	YI4	YE4	AVR..-4 (LH)
		5.0	4IR5.0TR...	4IL5.0TR...	2.75	2.1	2.5			
		6.0	4IR6.0TR...	4IL6.0TR...	3.50	2.3	2.7			
5/8"	27	6.0	5IR6.0TR...	5IL6.0TR...	3.50	2.3	2.7	YI5	YE5	AVR..-5 (LH)

Regelgewinde



Gewinde	Plattengröße		Bestellnummer	Abmessungen mm				Klemmhalter	Min. Bohrungsdurchmesser mm
	IC	L mm		h min	X	Y			
TR18x4	3/8"U	16	3UIR4.0TR...158/013	2.25	2.10	8.0	NVRC11-3U	156/020	14.0
TR20x4	3/8"	16	3IR4.0TR...158/012	2.25	1.53	1.9	NVRC13-3	156/006	16.0
TR22x5	3/8"U	16	3UIR5.0TR...158/011	2.75	1.56	8.0	NVRC14-3U	156/018	17.0
TR24x5			3UIR5.0TR...158/011	2.75	1.56	8.0	NVRC15-3U	156/019	19.0
TR26x5			3UIR5.0TR...158/011	2.75	1.56	8.0	NVRC15-3U	156/019	21.0
TR28x5	1/2"	22	4IR5.0TR...	2.75	2.30	2.7	NVRC20-4	156/008	23.0
TR30x6	1/2"U	22	4UIR6.0TR...158/007	3.50	1.94	11.0	NVRC20-4U	156/011	24.0
TR36x6	5/8"	27	5IR6.0TR...	3.50	2.30	2.7	NVRC25-5	156/012	30.0
TR38x7	1/2"U	22	4UIR7.0TR...158/008	4.00	2.27	11.0	NVRC25-4U	156/013	31.0
TR40x7			4UIR7.0TR...158/008	4.00	2.27	11.0	NVRC25-4U	156/013	33.0
TR42x7			4UIR7.0TR...158/008	4.00	2.27	11.0	NVRC32-4U	156/014	35.0
TR44x7			4UIR7.0TR...158/008	4.00	2.27	11.0	NVRC32-4U	156/014	37.0
TR46x8	5/8"U	27	5UIR8.0TR...158/010	4.50	2.59	13.5	NVRC32-5U	156/015	38.0
TR48x8			5UIR8.0TR...158/010	4.50	2.59	13.5	NVRC32-5U	156/015	40.0
TR50x8			5UIR8.0TR...158/010	4.50	2.59	13.5	NVRC32-5U	156/015	42.0
TR52x8			5UIR8.0TR...158/010	4.50	2.59	13.5	NVRC32-5U	156/015	44.0

LH Werkzeug lieferbar auf Anfrage.
U-Typ Gewindeschneidplatten können für linke und rechte Anwendungen verwendet werden

Trapez (Fortsetzung)

Innen

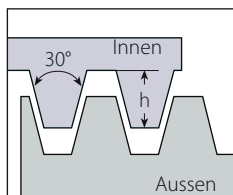

Norm: DIN 103
Toleranzklasse: 7e/7H

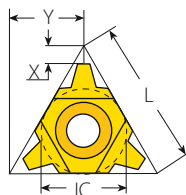

U Typ

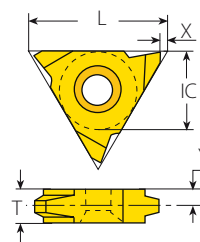

V Typ

U Typ



IC	L mm	Teilung mm	Bestellnummer RH+LH	Abmessungen mm			Unterlegplatte		Klemmhalter
				h min	X	Y	RH	LH	
1/2"U	22	6.0	4UI6.0TR...	3.50	2.0	11.0	Y14U	YE4U	AVR..-4U (LH)
		7.0	4UI7.0TR...	4.00	2.3	11.0			
		8.0	4UI8.0TR...	4.50	2.6	11.0			
5/8"U	27	8.0	5UI8.0TR...	4.50	2.6	13.7	Y15U	YE5U	AVR..-5U (LH)
		9.0	5UI9.0TR...	5.00	3.0	13.7			

V Typ



IC	L mm	Teilung mm	Bestellnummer		Abmessungen mm					Klemmhalter
			RH	LH	h min	X	Y	T		
5/8"V	27	6.0	5VIR6.0TR...	5VIL6.0TR...	3.50	1.0	3.3	6	NVR...-5V (LH)	
		7.0	5VIR7.0TR...	5VIL7.0TR...	4.00	1.0	3.3	6		
		8.0	5VIR8.0TR...	5VIL8.0TR...	4.50	1.0	3.3	6		
		9.0	5VIR9.0TR...	5VIL9.0TR...	5.00	1.0	4.3	8		
		10.0	5VIR10.0TR...	5VIL10.0TR...	5.50	1.0	4.3	8		
		12.0	5VIR12.0TR...	5VIL12.0TR...	6.50	1.0	5.2	10		



Innen

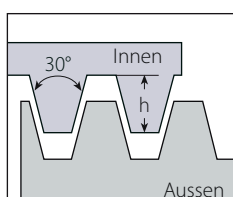

Norm: DIN 103
Toleranzklasse: 7e/7H

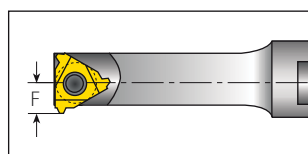
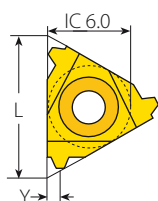

Mini3-Gewinde

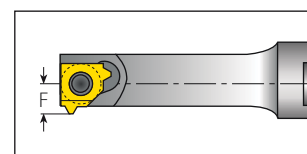
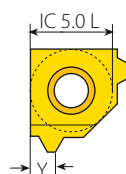

Mini-L-Gewinde

Mini-3 - Gewinde



IC	L mm	Teilung mm	Bestellnummer RH	Abmessungen mm			Min. Bohrungsdurchmesser	Klemmhalter
				h min	Y	F	mm	
6.0	10	1.5	6.0IR1.5TR...	0.85	0.85	5.3	10.0	.NVR1..-6.0
		2.0	6.0IR2.0TR...	1.25	1.30	5.3	10.0	

Mini-L - Gewinde



IC mm	Teilung mm	Bestellnummer RH	Abmessungen mm			Min. Bohrungsdurchmesser	Klemmhalter
			h min	Y	F	mm	
5.0L	1.5	5LIR1.5TR...	0.85	0.85	4.65	8.0	.NVR 10..-5L
	2.0	5LIR2.0TR...	1.25	1.30	4.65	8.0	

LH Werkzeug lieferbar auf Anfrage. (Beispiel: 6.0IL2.0TR...)

American ACME

Aussen

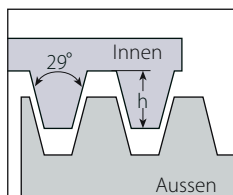

Norm: ANSI B1.5:1988
Toleranzklasse: 3G

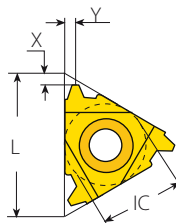

Standard

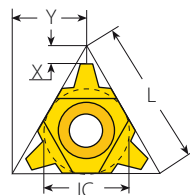

U Typ

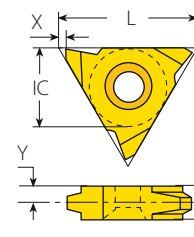

V Typ

Standard

Plattengrösse		Teilung	Bestellnummer		Abmessungen mm			Unterlegplatte			
IC	L mm	G/Z	RH	LH	h min	X	Y	RH	LH	Klemmhalter	
	1/4"	11	16	2ER16ACME...	2EL16ACME...	0.92	1.0	1.1	-	-	NL...-2 (LH)
		16	16	3ER16ACME...	3EL16ACME...	0.92	1.0	1.1	YE3	YI3	AL...-3 (LH)
	3/8"	16	14	3ER14ACME...	3EL14ACME...	1.03	1.0	1.2			
		12	3ER12ACME...	3EL12ACME...	1.19	1.1	1.2				
		10	3ER10ACME...	3EL10ACME...	1.52	1.3	1.4				
		8	3ER8ACME...	3EL8ACME...	1.84	1.4	1.5				
		7	3ER7ACME...	3EL7ACME...	2.08	1.9	2.2				
1/2"	22	6	4ER6ACME...	4EL6ACME...	2.37	1.8	2.1	YE4	YI4	AL...-4 (LH)	
		5	4ER5ACME...	4EL5ACME...	2.79	2.0	2.3				
	5/8"	27	4	5ER4ACME...	5EL4ACME...	3.43	2.4	2.7	YE5	YI5	AL...-5 (LH)

U Typ



Plattengrösse		Teilung	Bestellnummer		Abmessungen mm			Unterlegplatte		
IC	L mm	G/Z	RH+LH		h min	X	Y	RH	LH	Klemmhalter
1/2"U	22	3	4UE3ACME...		4.49	3.0	11.0	YE4U	YI4U	AL...-4U (LH)
		4	4UE4ACME...		3.43	2.3	11.0			
5/8"U	27	3	5UE3ACME...		4.49	3.0	13.7	YE5U	YI5U	AL...-5U (LH)

V Typ



Plattengrösse		Teilung	Bestellnummer		Abmessungen mm				
IC	L mm	G/Z	RH	LH	h min	X	Y	T	Klemmhalter
5/8"V	27	4	5VER4ACME...	5VEL4ACME...	3.43	1.0	3.3	6	NL...-5V-6 (LH)
		3.5	5VER3.5ACME...	5VEL3.5ACME...	3.85	1.0	3.3	6	
		3	5VER3ACME...	5VEL3ACME...	4.49	1.0	3.3	6	
		2	5VER2ACME...	5VEL2ACME...	6.60	1.0	5.2	10	

American ACME (Fortsetzung)

Innen

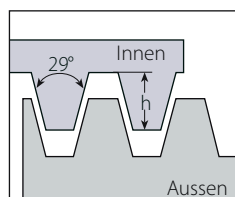

Norm: ANSI B1.5:1988
Toleranzklasse: 3G

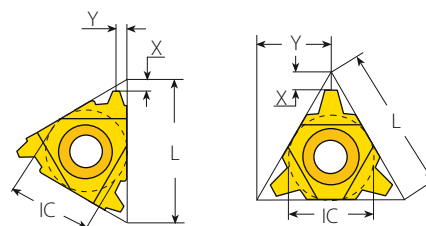

Standard

U Typ

Standard



Plattengröße		Teilung	Bestellnummer		Abmessungen mm			Unterlegplatte		Klemmhalter
IC	L mm	G/Z	RH	LH	h min	X	Y	RH	LH	
1/4"	11	16	2IR16ACME...	2IL16ACME...	0.92	0.9	0.9	-	-	NVR..-2 (LH)
3/8"	16	16	3IR16ACME...	3IL16ACME...	0.92	1.0	1.1	YI3	YE3	AVR..-3 (LH)
		14	3IR14ACME...	3IL14ACME...	1.03	1.1	1.2			
		12	3IR12ACME...	3IL12ACME...	1.19	1.2	1.3			
		10	3IR10ACME...	3IL10ACME...	1.52	1.2	1.3			
		8	3IR8ACME...	3IL8ACME...	1.84	1.4	1.5			
1/2"	22	6	4IR6ACME...	4IL6ACME...	2.37	1.8	2.1	YI4	YE4	AVR..-4 (LH)
		5	4IR5ACME...	4IL5ACME...	2.79	2.0	2.3			
5/8"	27	4	5IR4ACME...	5IL4ACME...	3.43	2.3	2.6	YI5	YE5	AVR..-5 (LH)

Regelgewinde



Gewinde Plattengröße		Bestellnummer		Abmessungen mm			Unterlegplatte		Min. Bohrungsdurchmesser
G/Z	IC	L mm	RH/LH	h min	X	Y	RH	Klemmhalter	
1/2"x10	6.0U	10	6.0UIR10ACME...158/005	1.52	1.0	5.2	-	NVRC 8-6.0U 156/003	10.16
5/8"x8	1/4"U	11	2UIR8ACME...158/006	1.84	1.0	5.5	-	NVRC 10-2U 156/004	12.70
3/4"x6	3/8"	16	3IR6ACME...	2.37	1.7	1.8	-	NVRC 11-3 156/005	14.82
7/8"x6			3IR6ACME...	2.37	1.7	1.8	-	NVRC 13-3 156/006	18.42
1"x5	1/2"	22	4IR5ACME...	2.79	2.0	2.3	-	NVRC 17-4 156/007	20.32
1 1/8"x5			4IR5ACME...	2.79	2.0	2.3	-	NVRC 20-4 156/008	24.00
1 1/4"x5			4IR5ACME...	2.79	2.0	2.3	-	NVRC 20-4 156/009	27.18
1 1/2"x4	5/8"	27	5IR4ACME...	3.43	2.3	2.6	-	NVRC 28-5 156/010	32.38
1 3/4"x4			5IR4ACME...	3.43	2.3	2.6	YI5 - 1P	AVRC 32-5	38.74

LH Werkzeug lieferbar auf Anfrage.

U-Typ Gewindeschneidplatten können für linke und rechte Anwendungen verwendet werden.

U Typ



Plattengröße		Teilung	Bestellnummer	Abmessungen mm			Unterlegplatte		Klemmhalter
IC	L mm	G/Z	RH+LH	h min	X	Y	RH	LH	
1/2"U	22	4	4UI4ACME...	3.43	2.3	11.0	YI4U	YE4U	AVR..-4U (LH)
		3	4UI3ACME...	4.49	2.9	11.0			
5/8"U	27	3	5UI3ACME...	4.49	2.9	13.7	YI5U	YE5U	AVR..-5U (LH)

American ACME (Fortsetzung)

Innen

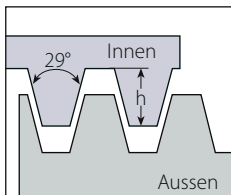

Norm: ANSI B1.5:1988
Toleranzklasse: 3G

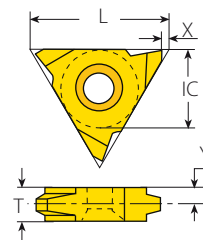

V Typ

V Typ



Plattengrösse		Teilung	Bestellnummer		Abmessungen mm				Klemmhalter
IC	L mm	G/Z	RH	LH	h min	X	Y	T	
5/8"V	27	4	5VIR4ACME...	5VIL4ACME...	3.43	1.0	3.3	6	NVR..-5V (LH)
		3.5	5VIR3.5ACME...	5VIL3.5ACME...	3.85	1.0	3.3	6	
		3	5VIR3ACME...	5VIL3ACME...	4.49	1.0	3.3	6	
		2	5VIR2ACME...	5VIL2ACME...	6.60	1.0	5.2	10	



Innen

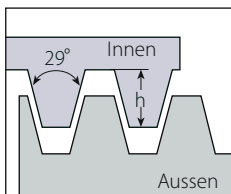

Norm: ANSI B1.5:1988
Toleranzklasse: 3G

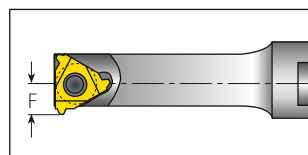
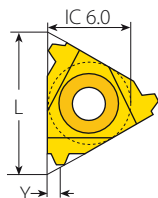

Mini3-Gewinde

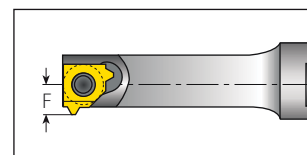
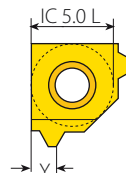

Mini-L-Gewinde

Mini-3 - Gewinde



Plattengrösse		Teilung	Bestellnummer	Abmessungen mm			Min. Bohrungsdurchmesser	Klemmhalter
IC	L mm	G/Z	RH	h min	Y	F	mm	
6.0	10	12	6.0IR12ACME...	1.19	1.1	5.1	10.0	.NVR1..-6.0

Mini-L - Gewinde



Plattengrösse		Teilung	Bestellnummer	Abmessungen mm			Min. Bohrungsdurchmesser	Klemmhalter
IC mm	G/Z	RH	h min	Y	F	mm		
5.0L	12	5LIR12ACME...	1.19	1.1	4.42	8.0	.NVR 10..-5L	

LH Werkzeug lieferbar auf Anfrage. (Beispiel: 6.0IL12ACME...)

Stub ACME

Aussen

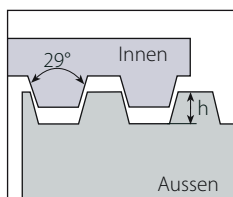

Norm: ANSI B1.8:1988
Toleranzklasse: 2G

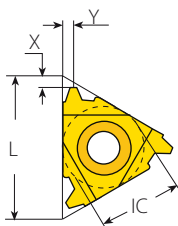

Standard

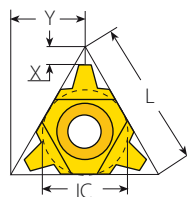

U Typ

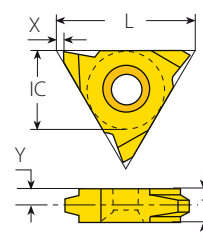

V Typ

Standard

Plattengrösse		Teilung	Bestellnummer		Abmessungen mm			Unterlegplatte		Klemmhalter
IC	L mm	G/Z	RH	LH	h min	X	Y	RH	LH	
1/4"	11	16	2ER16STACME...	2EL16STACME...	0.60	1.0	1.0	-	-	NL..-2 (LH)
		16	3ER16STACME...	3EL16STACME...	0.60	1.0	1.0			
		14	3ER14STACME...	3EL14STACME...	0.67	1.1	1.1			
		12	3ER12STACME...	3EL12STACME...	0.76	1.2	1.2	YE3	YI3	AL..-3 (LH)
		10	3ER10STACME...	3EL10STACME...	1.02	1.2	1.3			
		8	3ER8STACME...	3EL8STACME...	1.21	1.4	1.5			
1/2"	22	6	4ER6STACME...	4EL6STACME...	1.52	1.7	1.8			
		5	4ER5STACME...	4EL5STACME...	1.78	2.1	2.3	YE4	YI4	AL..-4 (LH)
		4	4ER4STACME...	4EL4STACME...	2.16	2.3	2.3			
5/8"	27	4	5ER4STACME...	5EL4STACME...	2.16	2.3	2.4	YE5	YI5	AL..-5 (LH)
		3	5ER3STACME...	5EL3STACME...	2.79	2.9	2.9			



U Typ

Plattengrösse		Teilung	Bestellnummer		Abmessungen mm			Unterlegplatte		Klemmhalter
IC	L mm	G/Z	RH+LH		h min	X	Y	RH	LH	
1/2"U	22	4	4UE4STACME...		2.16	2.6	11.0	YE4U	YI4U	AL..-4U (LH)
		3	4UE3STACME...		2.79	3.4	11.0			



V Typ

Plattengrösse		Teilung	Bestellnummer		Abmessungen mm				Klemmhalter
IC	L mm	G/Z	RH	LH	h min	X	Y	T	
5/8"V	27	4	5VER4STACME...	5VEL4STACME...	2.16	1.0	3.3	6	NL..-5V-6 (LH)
		3	5VER3STACME...	5VEL3STACME...	2.79	1.0	3.3	6	NL..-5V-6 (LH)
		2	5VER2STACME...	5VEL2STACME...	4.06	1.0	4.3	8	NL..-5V-8 (LH)



Stub ACME (Fortsetzung)

Innen

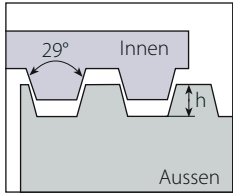

Norm: ANSI B1.8:1988
Toleranzklasse: 2G

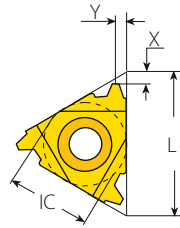

Standard

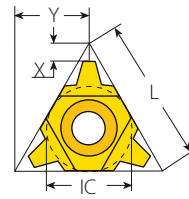

U Typ

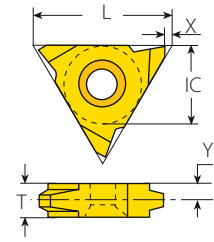

V Typ

Standard



Plattengröße		Teilung	Bestellnummer		Abmessungen mm			Unterlegplatte		Klemmhalter
IC	L mm	G/Z	RH	LH	h min	X	Y	RH	LH	
1/4"	11	16	2IR16STACME...	2IL16STACME...	0.60	1.0	1.0	-	-	NVR..-2 (LH)
		16	3IR16STACME...	3IL16STACME...	0.60	1.0	1.0			
		14	3IR14STACME...	3IL14STACME...	0.67	1.1	1.1			
		12	3IR12STACME...	3IL12STACME...	0.76	1.1	1.2	YI3	YE3	AVR..-3 (LH)
		10	3IR10STACME...	3IL10STACME...	1.02	1.2	1.3			
		8	3IR8STACME...	3IL8STACME...	1.21	1.4	1.5			
1/2"	22	6	4IR6STACME...	4IL6STACME...	1.52	1.7	1.8			
		5	4IR5STACME...	4IL5STACME...	1.78	2.1	2.3	YI4	YE4	AVR..-4 (LH)
		4	4IR4STACME...	4IL4STACME...	2.16	2.3	2.3			
5/8"	27	4	5IR4STACME...	5IL4STACME...	2.16	2.3	2.4	YI5	YE5	AVR..-5 (LH)
		3	5IR3STACME...	5IL3STACME...	2.79	2.9	2.9			

U Typ



Plattengröße		Teilung	Bestellnummer		Abmessungen mm			Unterlegplatte		Klemmhalter
IC	L mm	G/Z	RH+LH		h min	X	Y	RH	LH	
1/2"U	22	4	4UI4STACME...		2.16	2.5	11.0	YI4U	YE4U	AVR..-4U (LH)
		3	4UI3STACME...		2.79	3.3	11.0			

V Typ



Plattengröße		Teilung	Bestellnummer		Abmessungen mm				Klemmhalter
IC	L mm	G/Z	RH	LH	h min	X	Y	T	
5/8"V	27	4	5VIR4STACME...	5VIL4STACME...	2.16	1.0	3.3	6	
		3	5VIR3STACME...	5VIL3STACME...	2.79	1.0	3.3	6	NVR..-5V (LH)
		2	5VIR2STACME...	5VIL2STACME...	4.06	1.0	4.3	8	

Stub ACME (Fortsetzung)



Innen

Norm: ANSI B1.8:1988
Toleranzklasse: 2G

Mini3-Gewinde **Mini-L-Gewinde**

Mini-3 - Gewinde



Plattengröße		Teilung	Bestellnummer	Abmessungen mm			Min. Bohrungsdurchmesser	Klemmhalter
IC	L mm	G/Z	RH	h min	Y	F	mm	
6.0	10	12	6.0IR12STACME...	0.76	1.2	5.1	10.0	.NVR1.-6.0

Mini-L - Gewinde



Plattengröße		Teilung	Bestellnummer	Abmessungen mm			Min. Bohrungsdurchmesser	Klemmhalter
IC mm	G/Z	RH	h min	Y	F	mm		
5.0L	12	5LIR12STACME...	0.76	1.2	4.42	8.0	.NVR 10. -5L	

LH Werkzeug lieferbar auf Anfrage. (Beispiel: 6.0IL12STACME...)

UNJ - UNJC, UNJF, UNJEF, UNJS

Aussen

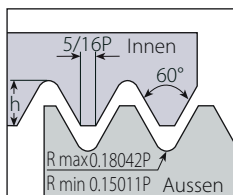

Norm: MIL-S-8879C
Toleranzklasse: 3A/3B

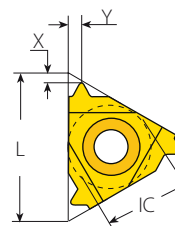

Standard

Standard

Plattengrösse		Teilung	Bestellnummer		Abmessungen mm			Unterlegplatte		Klemmhalter					
IC	L mm	G/Z	RH	LH	h min	X	Y	RH	LH						
1/4"	11	48	2ER48UNJ...	2EL48UNJ...	0.31	0.6	0.5	-	-	NL...-2 (LH)					
		44	2ER44UNJ...	2EL44UNJ...	0.33	0.6	0.6								
		40	2ER40UNJ...	2EL40UNJ...	0.37	0.6	0.6								
		36	2ER36UNJ...	2EL36UNJ...	0.41	0.6	0.6								
		32	2ER32UNJ...	2EL32UNJ...	0.46	0.6	0.7								
		28	2ER28UNJ...	2EL28UNJ...	0.52	0.7	0.7								
		24	2ER24UNJ...	2EL24UNJ...	0.61	0.7	0.8								
		20	2ER20UNJ...	2EL20UNJ...	0.73	0.8	0.9								
		18	2ER18UNJ...	2EL18UNJ...	0.81	0.8	1.0								
		16	2ER16UNJ...	2EL16UNJ...	0.92	0.9	1.1								
		14	2ER14UNJ...	2EL14UNJ...	1.05	1.0	1.2								
		3/8"	16	48	3ER48UNJ...	3EL48UNJ...	0.31				0.6	0.5	YE3	YI3	AL...-3 (LH)
				44	3ER44UNJ...	3EL44UNJ...	0.33				0.6	0.6			
				40	3ER40UNJ...	3EL40UNJ...	0.37				0.6	0.6			
36	3ER36UNJ...			3EL36UNJ...	0.41	0.6	0.6								
32	3ER32UNJ...			3EL32UNJ...	0.46	0.6	0.7								
28	3ER28UNJ...			3EL28UNJ...	0.52	0.7	0.7								
24	3ER24UNJ...			3EL24UNJ...	0.61	0.7	0.8								
20	3ER20UNJ...			3EL20UNJ...	0.73	0.8	0.9								
18	3ER18UNJ...			3EL18UNJ...	0.81	0.8	1.0								
16	3ER16UNJ...			3EL16UNJ...	0.92	0.9	1.1								
14	3ER14UNJ...			3EL14UNJ...	1.05	1.0	1.2								
13	3ER13UNJ...			3EL13UNJ...	1.13	1.0	1.3								
12	3ER12UNJ...			3EL12UNJ...	1.22	1.1	1.3								
11	3ER11UNJ...			3EL11UNJ...	1.33	1.2	1.5								
10	3ER10UNJ...	3EL10UNJ...	1.47	1.2	1.5										
9	3ER9UNJ...	3EL9UNJ...	1.63	1.3	1.7										
8	3ER8UNJ...	3EL8UNJ...	1.83	1.2	1.6										



Weiter Nächste Seite ▶

UNJ - UNJC, UNJF, UNJEF, UNJS (Fortsetzung)

Aussen

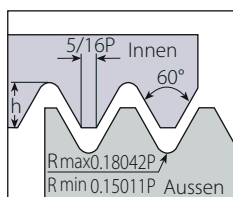

Norm: MIL-S-8879C
Toleranzklasse: 3A/3B

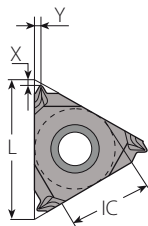

SCB
Gesinterter
Spanbrecher

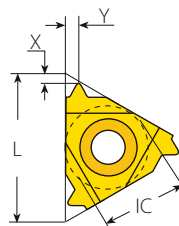

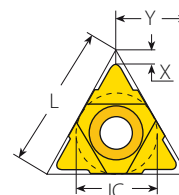

Standard



U Typ

Standard (Fortsetzung)

Plattengrösse		Teilung	Bestellnummer		Abmessungen mm			Unterlegplatte		Klemmhalter	
IC	L mm	G/Z	RH	LH	h min	X	Y	RH	LH		
 SCB	3/8" SCB	16	36	3JER36UNJ...		0.41	1.3	0.5	YE3	-	AL..-3
			32	3JER32UNJ...		0.46	1.2	0.5			
			28	3JER28UNJ...		0.52	0.7	0.8			
			24	3JER24UNJ...		0.61	0.7	0.8			
			20	3JER20UNJ...		0.73	0.7	0.8			
			18	3JER18UNJ...		0.81	0.7	0.8			
			16	3JER16UNJ...		0.92	0.8	0.8			
			14	3JER14UNJ...		1.05	1.3	1.5			
			12	3JER12UNJ...		1.22	1.3	1.5			
			10	3JER10UNJ...		1.47	1.3	1.5			
 Standard	1/2"	22	7	4ER7UNJ...	4EL7UNJ...	2.09	1.7	2.3	YE4	Y14	AL..-4 (LH)
			6	4ER6UNJ...	4EL6UNJ...	2.44	1.7	2.3			
			5	4ER5UNJ...	4EL5UNJ...	2.93	1.8	2.5			
 U Typ	5/8"	27	4.5	5ER4.5UNJ...	5EL4.5UNJ...	3.26	2.0	2.7	YE5	Y15	AL..-5 (LH)
			4	5ER4UNJ...	5EL4UNJ...	3.67	2.2	3.1			

U Typ

Plattengrösse		Teilung	Bestellnummer	Abmessungen mm			Unterlegplatte		Klemmhalter	
IC	L mm	G/Z	RH+LH	h min	X	Y	RH	LH		
 U Typ	1/2"U	22	4.5	4UE4.5UNJ...	3.26	2.1	11.0	YE4U	Y14U	AL..-4U (LH)
			4	4UE4UNJ...	3.67	2.2	11.0			

UNJ - UNJC, UNJF, UNJEF, UNJS (Fortsetzung)

Innen

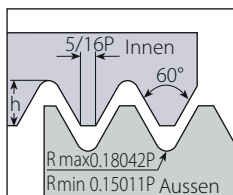

Norm: MIL-S-8879C
Toleranzklasse: 3A/3B

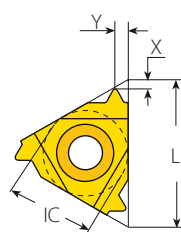

Standard

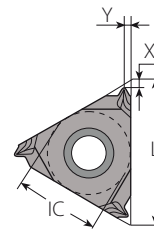

SCB
Gesinterter
Spanbrecher

Standard

Plattengröße		Teilung	Bestellnummer		Abmessungen mm			Unterlegplatte		Klemmhalter
IC	L mm	G/Z	RH	LH	h min	X	Y	RH	LH	
1/4"	11	48	2IR48UNJ...	2IL48UNJ...	0.28	0.6	0.5	-	-	NVR..-2 (LH)
		44	2IR44UNJ...	2IL44UNJ...	0.30	0.6	0.6			
		40	2IR40UNJ...	2IL40UNJ...	0.33	0.6	0.6			
		36	2IR36UNJ...	2IL36UNJ...	0.37	0.6	0.6			
		32	2IR32UNJ...	2IL32UNJ...	0.42	0.6	0.7			
		28	2IR28UNJ...	2IL28UNJ...	0.47	0.7	0.7			
		24	2IR24UNJ...	2IL24UNJ...	0.55	0.7	0.8			
		20	2IR20UNJ...	2IL20UNJ...	0.66	0.8	0.9			
		18	2IR18UNJ...	2IL18UNJ...	0.74	0.8	1.0			
		16	2IR16UNJ...	2IL16UNJ...	0.83	0.9	1.1			
1/4" SCB	11	36	2JIR36UNJ...		0.37	1.1	0.5	-	-	NVR..-2
		32	2JIR32UNJ...		0.42	1.2	0.5			
		28	2JIR28UNJ...		0.47	0.6	0.8			
		24	2JIR24UNJ...		0.55	0.6	0.8			
		20	2JIR20UNJ...		0.66	0.6	0.8			
		18	2JIR18UNJ...		0.74	0.6	0.8			
		16	2JIR16UNJ...		0.83	0.6	0.8			
		14	2JIR14UNJ...		0.95	0.6	0.8			



SCB

Weiter Nächste Seite ▶

UNJ - UNJC, UNJF, UNJEF, UNJS (Fortsetzung)

Innen

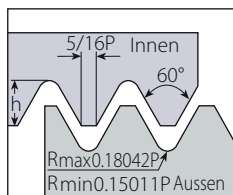

Norm: MIL-S-8879C
Toleranzklasse: 3A/3B

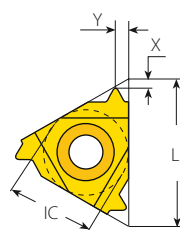

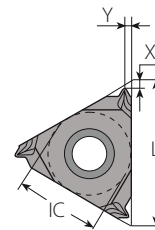

Standard



SCB
Gesinterter
Spanbrecher

Standard (Fortsetzung)

Plattengröße		Teilung	Bestellnummer		Abmessungen mm			Unterlegplatte		Klemmhalter	
IC	L mm	G/Z	RH	LH	h min	X	Y	RH	LH		
	3/8"	16	48	3IR48UNJ...	3IL48UNJ...	0.28	0.6	0.5	Y13	YE3	AVR..-3 (LH)
			44	3IR44UNJ...	3IL44UNJ...	0.30	0.6	0.6			
			40	3IR40UNJ...	3IL40UNJ...	0.33	0.6	0.6			
			36	3IR36UNJ...	3IL36UNJ...	0.37	0.6	0.6			
			32	3IR32UNJ...	3IL32UNJ...	0.42	0.6	0.7			
			28	3IR28UNJ...	3IL28UNJ...	0.47	0.7	0.7			
			24	3IR24UNJ...	3IL24UNJ...	0.55	0.7	0.8			
			20	3IR20UNJ...	3IL20UNJ...	0.66	0.8	0.9			
			18	3IR18UNJ...	3IL18UNJ...	0.74	0.8	1.0			
			16	3IR16UNJ...	3IL16UNJ...	0.83	0.9	1.1			
			14	3IR14UNJ...	3IL14UNJ...	0.95	1.0	1.2			
			13	3IR13UNJ...	3IL13UNJ...	1.02	1.0	1.3			
			12	3IR12UNJ...	3IL12UNJ...	1.11	1.1	1.3			
			11	3IR11UNJ...	3IL11UNJ...	1.21	1.2	1.5			
			10	3IR10UNJ...	3IL10UNJ...	1.33	1.2	1.5			
			9	3IR9UNJ...	3IL9UNJ...	1.48	1.3	1.7			
8	3IR8UNJ...	3IL8UNJ...	1.66	1.2	1.6						
	3/8" SCB	16	28	3JIR28UNJ...		0.47	0.6	0.8	Y13	-	AVR..-3
			24	3JIR24UNJ...		0.55	0.6	0.8			
			20	3JIR20UNJ...		0.66	0.6	0.8			
			18	3JIR18UNJ...		0.74	0.6	0.8			
			16	3JIR16UNJ...		0.83	0.6	0.8			
			14	3JIR14UNJ...		0.95	1.1	1.5			
	1/2"	22	7	4IR7UNJ...	4IL7UNJ...	1.90	1.7	2.3	Y14	YE4	AVR..-4 (LH)
			6	4IR6UNJ...	4IL6UNJ...	2.21	1.7	2.3			
			5	4IR5UNJ...	4IL5UNJ...	2.66	1.8	2.5			
	5/8"	27	4.5	5IR4.5UNJ...	5IL4.5UNJ...	2.95	2.0	2.7	Y15	YE5	AVR..-5 (LH)
			4	5IR4UNJ...	5IL4UNJ...	3.32	2.2	2.4			

UNJ - UNJC, UNJF, UNJEF, UNJS (Fortsetzung)

Innen

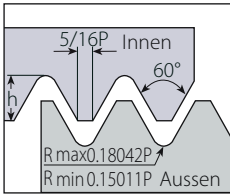

Norm: MIL-S-8879C
Toleranzklasse: 3A/3B

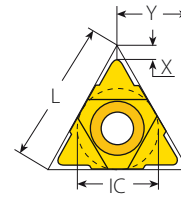

U Typ

U Typ



Plattengrösse		Teilung	Bestellnummer	Abmessungen mm			Unterlegplatte		
IC	L mm	G/Z	RH+LH	h min	X	Y	RH	LH	Klemmhalter
1/2"U	22	4.5	4UI4.5UNJ...	2.95	2.1	11.0	YI4U	YE4U	AVR..-4U (LH)
		4	4UI4UNJ...	3.32	2.2	11.0			

UNJ - UNJC, UNJF, UNJEF, UNJS (Fortsetzung)



Innen

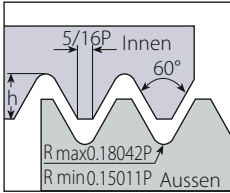

Norm: MIL-S-8879C
Toleranzklasse: 3A/3B

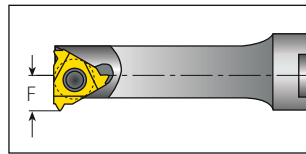
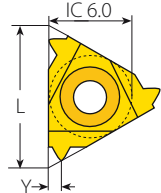

Mini3-Gewinde

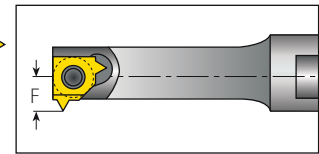
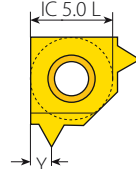

Mini-L-Gewinde

Mini-3 - Gewinde



Plattengrösse		Teilung	Bestellnummer	Abmessungen mm			Min. Bohrungsdurchmesser	Klemmhalter
IC	L mm	G/Z	RH	h min	Y	F	mm	
6.0	10	20	6.0IR20UNJ...	0.66	0.9	4.90	9.8	.NVR1..-6.0

Mini-L - Gewinde



Plattengrösse		Teilung	Bestellnummer	Abmessungen mm			Min. Bohrungsdurchmesser	Klemmhalter
IC mm		G/Z	RH	h min	Y	F	mm	
5.0L		32	5LIR32UNJ...	0.42	0.6	3.92	7.5	.NVR 10. -5L
		28	5LIR28UNJ...	0.47	0.6	3.99	7.6	
		20	5LIR20UNJ...	0.66	0.9	4.21	7.8	
		18	5LIR18UNJ...	0.74	1.0	4.30	7.9	
		16	5LIR16UNJ...	0.83	1.0	4.41	8.0	
		14	5LIR14UNJ...	0.95	1.0	4.54	8.0	

LH Werkzeug lieferbar auf Anfrage. (Beispiel: 6.0IL20UNJ..)

MJ

Aussen

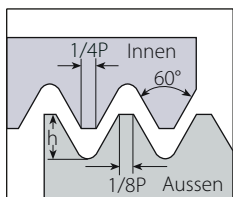

Norm: ISO 5855
Toleranzklasse: 4h/6h-4H/5H

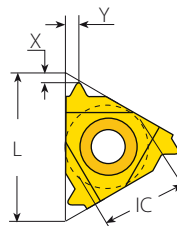

Aussen - Norm

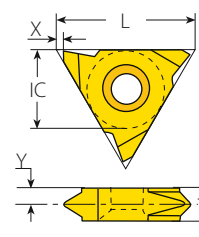

Slim Throat

Standard



Plattengrösse		Teilung	Bestellnummer		Abmessungen mm			Unterlegplatte		
IC	L mm	mm	RH	LH	h min	X	Y	RH	LH	Klemmhalter
1/4"	11	1.0	2ER1.0MJ...	2EL1.0MJ...	0.58	0.7	0.7	-	-	NL..-2 (LH)
		1.25	2ER1.25MJ...	2EL1.25MJ...	0.72	0.8	0.9			
		1.5	2ER1.5MJ...	2EL1.5MJ...	0.87	0.8	1.0			
3/8"	16	0.7	3ER0.7MJ...	3EL0.7MJ...	0.40	0.6	0.6	YE3	YI3	AL..-3 (LH)
		1.0	3ER1.0MJ...	3EL1.0MJ...	0.58	0.7	0.7			
		1.25	3ER1.25MJ...	3EL1.25MJ...	0.72	0.8	0.9			
		1.5	3ER1.5MJ...	3EL1.5MJ...	0.87	0.8	1.0			
		2.0	3ER2.0MJ...	3EL2.0MJ...	1.15	1.0	1.3			
		2.5	3ER2.5MJ...	3EL2.5MJ...	1.49	1.1	1.5			
3.0	3ER3.0MJ...	3EL3.0MJ...	1.73	1.2	1.6					

Slim Throat



Plattengrösse		Teilung	Bestellnummer		Abmessungen mm				Klemmhalter
IC	L mm	mm	RH	LH	h min	X	Y	T	
1/4"V	11	0.7	2VER0.7MJ	2VEL0.7MJ	0.40	0.7	2.5	3.2	NL..-2V (LH)
		0.8	2VER0.8MJ	2VEL0.8MJ	0.44	0.7	2.5	3.2	
		0.9	2VER0.9MJ	2VEL0.9MJ	0.53	0.7	2.6	3.2	
		1.0	2VER1.0MJ	2VEL1.0MJ	0.58	0.7	2.5	3.2	
		1.25	2VER1.25MJ	2VEL1.25MJ	0.72	0.7	2.3	3.2	
		1.5	2VER1.5MJ	2VEL1.5MJ	0.87	0.7	2.2	3.2	

MJ

Innen

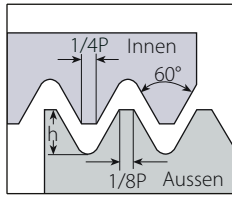

Norm: ISO 5855
Toleranzklasse: 4h/6h-4H/5H

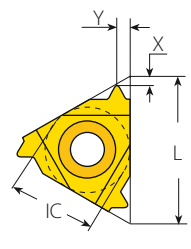

Innen - Norm

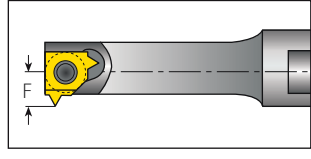
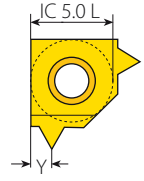

Mini-L-Gewinde

Standard



Plattengröße		Teilung	Bestellnummer		Abmessungen mm			Unterlegplatte		Klemmhalter
IC	L mm	mm	RH	LH	h min	X	Y	RH	LH	
1/4"	11	1.0	2IR1.0MJ...	2IL1.0MJ...	0.49	0.6	0.7	-	-	NVR..-2 (LH)
		1.25	2IR1.25MJ...	2IL1.25MJ...	0.61	0.8	0.9			
		1.5	2IR1.5MJ...	2IL1.5MJ...	0.73	0.8	1.0			
		2.0	2IR2.0MJ...	2IL2.0MJ...	0.97	0.8	1.0			
3/8"	16	0.75	3IR0.75MJ...	3IL0.75MJ...	0.37	0.6	0.6	Y13	YE3	AVR..-3 (LH)
		1.0	3IR1.0MJ...	3IL1.0MJ...	0.49	0.6	0.7			
		1.25	3IR1.25MJ...	3IL1.25MJ...	0.61	0.8	0.9			
		1.5	3IR1.5MJ...	3IL1.5MJ...	0.73	0.8	1.0			
		2.0	3IR2.0MJ...	3IL2.0MJ...	0.97	0.8	1.3			
		2.5	3IR2.5MJ...	3IL2.5MJ...	1.23	1.1	1.5			
3.0	3IR3.0MJ...	3IL3.0MJ...	1.46	1.2	1.6					

Mini-L - Gewinde



Plattengröße	Teilung	Bestellnummer	Abmessungen mm				Min. Bohrungsdurchmesser	Klemmhalter
IC mm	mm	RH	h min	Y	F	mm		
5.0L	1.0	5LIR1.0MJ...	0.49	0.7	4.06	7.7	.NVR 10. -5L	
	1.25	5LIR1.25MJ...	0.61	0.9	4.21	7.8		
	1.5	5LIR1.50MJ...	0.73	1.0	4.35	7.9		

American Buttress

Aussen

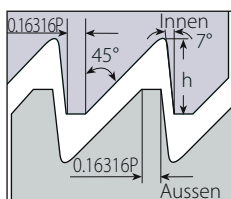

Norm: ANSI B1.9.1973
Toleranzklasse: Class 2

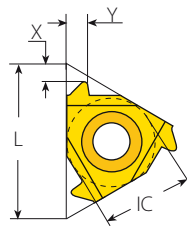

Standard

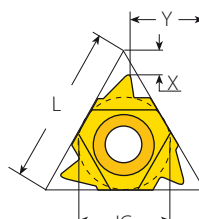

U Typ

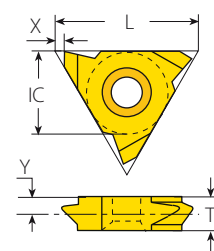

V Typ

Standard



Plattengrösse		Teilung	Bestellnummer		Abmessungen mm			Unterlegplatte		
IC	L mm	G/Z	RH	LH	h min	X	Y	RH	LH	Klemmhalter
1/4"	11	20	2ER20ABUT...	2EL20ABUT...	0.84	1.0	1.4	-	-	NL..-2 (LH)
		16	2ER16ABUT...	2EL16ABUT...	1.05	1.3	1.9	-	-	
3/8"	16	20	3ER20ABUT...	3EL20ABUT...	0.84	1.0	1.4	YE3	YI3	AL..-3 (LH)
		16	3ER16ABUT...	3EL16ABUT...	1.05	1.3	1.9			
		12	3ER12ABUT...	3EL12ABUT...	1.40	1.4	2.0			
		10	3ER10ABUT...	3EL10ABUT...	1.68	1.5	2.3			
1/2"	22	8	4ER8ABUT...	4EL8ABUT...	2.10	2.0	3.2	YE4	YI4	AL..-4 (LH)
		6	4ER6ABUT...	4EL6ABUT...	2.80	2.2	3.5			



U Typ



Plattengrösse		Teilung	Bestellnummer		Abmessungen mm			Unterlegplatte		
IC	L mm	G/Z	RH	LH	h min	X	Y	RH	LH	Klemmhalter
1/2"U	22	4	4UER4ABUT...	4UEL4ABUT...	4.21	2.4	9.8	YE4U-BUT4	YI4U-BUT4	AL..-4U (LH)
5/8"U	27	3	5UER3ABUT...	5UEL3ABUT...	5.61	3.1	12.1	YE5U-BUT3	YI5U-BUT3	AL..-5U (LH)

V Typ



Plattengrösse		Teilung	Bestellnummer		Abmessungen mm				
IC	L mm	G/Z	RH	LH	h min	X	Y	T	Klemmhalter
5/8"V	27	4	5VER4ABUT...	5VEL4ABUT...	4.21	0.6	1.8	6	NL..-5V-6 (LH)
		3	5VER3ABUT...	5VEL3ABUT...	5.61	0.6	2.2	8	NL..-5V-8 (LH)
		2.5	5VER2.5ABUT...	5VEL2.5ABUT...	6.73	0.6	2.7	10	NL..-5V-10ABUT (LH)

American Buttress (Fortsetzung)

Innen

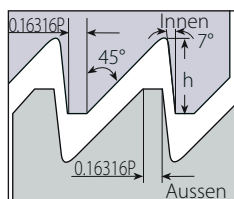

Norm: ANSI B1.9.1973
Toleranzklasse: Class 2

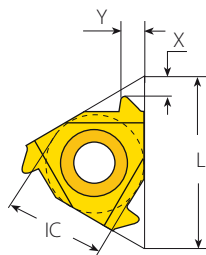

Standard

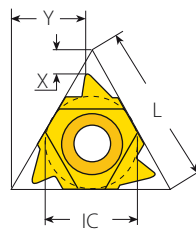

U Typ

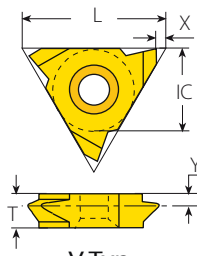

V Typ

Standard



Plattengrösse		Teilung	Bestellnummer		Abmessungen mm			Unterlegplatte		Klemmhalter
IC	L mm	G/Z	RH	LH	h min	X	Y	RH	LH	
1/4"	11	20	2IR20ABUT...	2IL20ABUT...	0.84	1.0	1.4	-	-	NVR..-2 (LH)
		16	2IR16ABUT...	2IL16ABUT...	1.05	1.3	1.9	-	-	
3/8"	16	20	3IR20ABUT...	3IL20ABUT...	0.84	1.0	1.4	YI3	YE3	AVR..-3 (LH)
		16	3IR16ABUT...	3IL16ABUT...	1.05	1.3	1.9			
		12	3IR12ABUT...	3IL12ABUT...	1.40	1.4	2.0			
		10	3IR10ABUT...	3IL10ABUT...	1.68	1.5	2.3			
1/2"	22	8	4IR8ABUT...	4IL8ABUT...	2.10	2.0	3.2	YI4	YE4	AVR..-4 (LH)
		6	4IR6ABUT...	4IL6ABUT...	2.80	2.2	3.5			



U Typ



Plattengrösse		Teilung	Bestellnummer		Abmessungen mm			Unterlegplatte		Klemmhalter
IC	L mm	G/Z	RH	LH	h min	X	Y	RH	LH	
1/2"U	22	4	4UIR4ABUT...	4UIL4ABUT...	4.21	2.4	9.8	YI4U-4B	YE4U-4B	AVR..-4U (LH)
5/8"U	27	3	5UIR3ABUT...	5UIL3ABUT...	5.61	3.1	12.1	YI5U-3B	YE5U-3B	AVR..-5U (LH)

V Typ



Plattengrösse		Teilung	Bestellnummer		Abmessungen mm			Klemmhalter	
IC	L mm	G/Z	RH	LH	h min	X	Y		T
5/8"V	27	4	5VIR4ABUT...	5VIL4ABUT...	4.21	0.6	1.8	6	NVR..-5V (LH)
		3	5VIR3ABUT...	5VIL3ABUT...	5.61	0.6	2.2	8	
		2.5	5VIR2.5ABUT...	5VIL2.5ABUT...	6.73	0.6	2.7	10	

British Buttress

Aussen

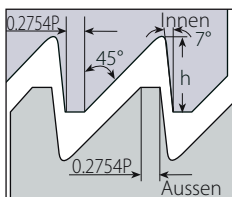

Norm: B.S. 1657: 1950
Toleranzklasse: Medium Class

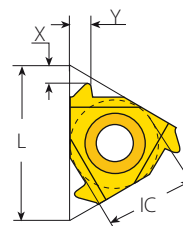

Standard

Standard



Plattengrösse		Teilung	Bestellnummer		Abmessungen mm			Unterlegplatte		
IC	L mm	G/Z	RH	LH	h min	X	Y	RH	LH	Klemmhalter
3/8"	16	16	3ER16BBUT...	3EL16BBUT...	0.80	1.1	1.6	YE3	YI3	AL..-3 (LH)
		12	3ER12BBUT...	3EL12BBUT...	1.07	1.4	2.1			
		10	3ER10BBUT...	3EL10BBUT...	1.28	1.4	2.2			
		8	3ER8BBUT...	3EL8BBUT...	1.61	1.6	2.5			
1/2"	22	8	4ER8BBUT...	4EL8BBUT...	1.61	1.6	2.5	YE4	YI4	AL..-4 (LH)

British Buttress

Innen

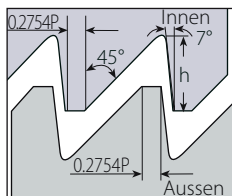

Norm: B.S. 1657: 1950
Toleranzklasse: Medium Class

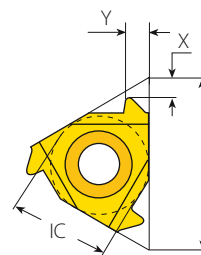

Standard

Standard



Plattengrösse		Teilung	Bestellnummer		Abmessungen mm			Unterlegplatte		
IC	L mm	G/Z	RH	LH	h min	X	Y	RH	LH	Klemmhalter
3/8"	16	16	3IR16BBUT...	3IL16BBUT...	0.80	1.1	1.6	YI3	YE3	AVR..-3 (LH)
		12	3IR12BBUT...	3IL12BBUT...	1.07	1.4	2.1			
		10	3IR10BBUT...	3IL10BBUT...	1.28	1.4	2.2			
		8	3IR8BBUT...	3IL8BBUT...	1.61	1.6	2.5			
1/2"	22	8	4IR8BBUT...	4IL8BBUT...	1.61	1.6	2.5	YI4	YE4	AVR..-4 (LH)

Metrisch Säge (Sägengewinde)

Aussen / Innen

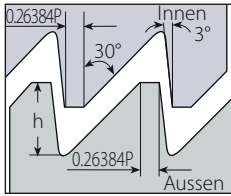

Norm: DIN 513
Toleranzklasse: Medium Class

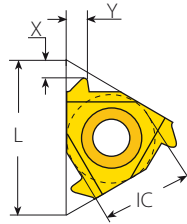

Aussen
Standard

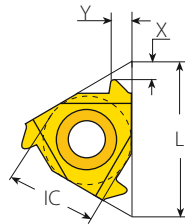

Innen
Standard

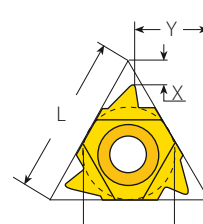

Aussen
U Typ

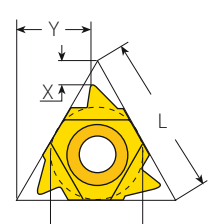

Innen
U Typ

Aussen - Standard



Plattengrösse		Teilung	Bestellnummer		Abmessungen mm			Unterlegplatte		
IC	L mm	mm	RH	LH	h min	X	Y	RH	LH	Klemmhalter
3/8"	16	2.0	3ER2.0SAGE...	3EL2.0SAGE...	1.74	1.5	2.1	YE3	YI3	AL..-3 (LH)
		2.0	4ER2.0SAGE...	4EL2.0SAGE...	1.74	1.5	2.1			
1/2"	22	3.0	4ER3.0SAGE...	4EL3.0SAGE...	2.60	1.8	2.6	YE4	YI4	AL..-4 (LH)
		4.0	4ER4.0SAGE...	4EL4.0SAGE...	3.55	1.75	3.1			
5/8"	27	4.0	5ER4.0SAGE...	5EL4.0SAGE...	3.55	1.9	3.2	YE5 082/038	YI5 082/039	AL..-5 (LH)

U Style - External



Plattengrösse		Teilung	Bestellnummer		Abmessungen mm			Unterlegplatte		
IC	L mm	mm	RH	LH	h min	X	Y	RH	LH	Klemmhalter
1/2"U	22	5	4UER5.0SAGE...	4UEL5.0SAGE...	4.41	1.27	10.35	YE4U-SAGE5	YI4U-SAGE5	AL..-4U (LH)
		6	4UER6.0SAGE...	4UEL6.0SAGE...	5.29	1.25	10.28	YE4U-SAGE6	YI4U-SAGE6	

Innen - Standard



Plattengrösse		Teilung	Bestellnummer		Abmessungen mm			Unterlegplatte		
IC	L mm	mm	RH	LH	h min	X	Y	RH	LH	Klemmhalter
3/8"	16	2.0	3IR2.0SAGE...	3IL2.0SAGE...	1.50	1.5	2.2	YI3	YE3	AVR..-3 (LH)
		3.0	4IR3.0SAGE...	4IL3.0SAGE...	2.25	1.7	2.9	YI4	YE4	AVR..-4 (LH)
1/2"	22	4.0	4IR4.0SAGE...	4IL4.0SAGE...	3.09	2.03	3.25			
		4.0	5IR4.0SAGE...	5IL4.0SAGE...	3.09	2.1	3.2	YI5 082/039	YE5 082/038	AVR..-5 (LH)

U Typ - Innen



Plattengrösse		Teilung	Bestellnummer		Abmessungen mm			Unterlegplatte		
IC	L mm	mm	RH	LH	h min	X	Y	RH	LH	Klemmhalter
1/2"U	22	5	4UIR5.0SAGE...	4UIL5.0SAGE...	3.76	1.8	10.3	YI4U-5S	YE4U-5S	AVR..-4U (LH)
		6	4UIR6.0SAGE...	4UIL6.0SAGE...	4.54	1.9	10.15	YI4U-6S	YE4U-6S	

API

Aussen / Innen

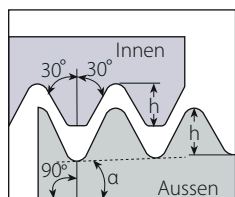

$$\alpha = \arctg (IPF/24)$$

Norm: API SPEC. 7:1990
Toleranzklasse: Standard API

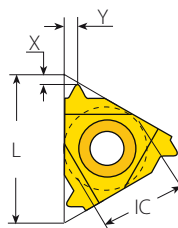

Aussen - Norm

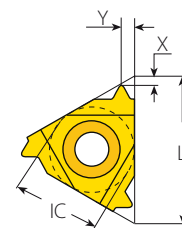

Innen - Norm

Aussen - Standard

Plattengrösse		Teilung	Gewinde	Konus	Bestellnummer	Grösse	Abmessungen mm			Unterlegplatte	
IC	L mm	G/Z		IPF	RH		h min	X	Y	RH	Klemmhalter
1/2"	22	4	V-0.038R	2	4ER4API382...	NC23-NC50	3.09	2.1	2.8	YE4	AL..-4 (LH)
		4	V-0.038R	3	4ER4API383...	NC56-NC77	3.08	2.1	2.8		
		4	V-0.050	2	4ER4API502...	6 5/8" REG	3.75	2.0	2.9		
		4	V-0.050	3	4ER4API503...	5 1/2", 7 5/8", 8 5/8" REG	3.74	2.0	2.9		
		5	V-0.040	3	4ER5API403...	2 3/8"-4 1/2" REG	2.99	1.8	2.6		
		6	V-0.055	1.5	4ER6API551...	NC10-NC16	1.41	2.6	2.0		
5/8"	27	4	V-0.038R	2	5ER4API382...	NC23-NC50	3.09	2.1	2.8	YE5OIL	AL..-5 OIL (LH)
		4	V-0.038R	3	5ER4API383...	NC56-NC77	3.08	2.1	2.8		
		4	V-0.050	2	5ER4API502...	6 5/8" REG	3.75	2.1	3.1		
		4	V-0.050	3	5ER4API503...	5 1/2", 7 5/8", 8 5/8" REG	3.74	2.1	3.1		
		5	V-0.040	3	5ER5API403...	2 3/8"-4 1/2" REG	2.99	1.9	2.7		



Innen - Standard

Plattengrösse		Teilung	Gewinde	Konus	Bestellnummer	Grösse	Abmessungen mm			Unterlegplatte	
IC	L mm	G/Z		IPF	RH		h min	X	Y	RH	Klemmhalter
1/2"	22	4	V-0.038R	2	4IR4API382...	NC23-NC50	3.09	2.1	2.8	YI4	AVR..-4 (LH)
		4	V-0.038R	3	4IR4API383...	NC56-NC77	3.08	2.1	2.8		
		4	V-0.050	2	4IR4API502...	6 5/8" REG	3.75	2.1	3.1		
		4	V-0.050	3	4IR4API503...	5 1/2", 7 5/8", 8 5/8" REG	3.74	2.0	2.9		
		5	V-0.040	3	4IR5API403...	2 3/8"-4 1/2" REG	2.99	1.8	2.6		
		6	V-0.055	1.5	4IR6API551...	NC10-NC16	1.41	2.6	2.0		
5/8"	27	4	V-0.038R	2	5IR4API382...	NC23-NC50	3.09	2.1	2.8	YI5OIL	AVR..-5 OIL (LH)
		4	V-0.038R	3	5IR4API383...	NC56-NC77	3.08	2.1	2.8		
		4	V-0.050	2	5IR4API502...	6 5/8" REG	3.75	2.1	3.1		
		4	V-0.050	3	5IR4API503...	5 1/2", 7 5/8", 8 5/8" REG	3.74	2.1	3.1		
		5	V-0.040	3	5IR5API403...	2 3/8"-4 1/2" REG	2.99	1.9	2.7		



API Buttress Casing

Aussen

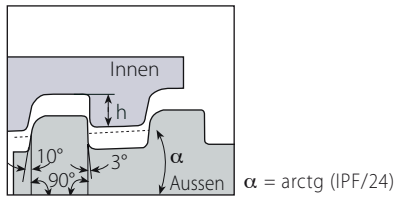

Norm: STD.5B:1979
Toleranzklasse: Standard API

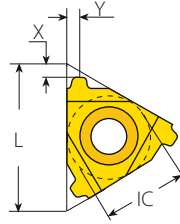

Standard

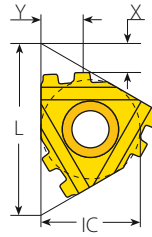

M+ Typ

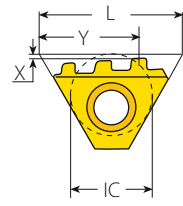

T+ Typ

Standard



Plattengrösse		Teilung	Konus	Bestellnummer	Grösse	Abmessungen mm			Unterlegplatte	
IC	L mm	G/Z	IPF	RH		h min	X	Y	RH	Klemmhalter
1/2"	22	5	0.75	4ER5BUT75...	4 1/2"-13 3/8"	1.55	3.1	1.9	YE4	AL..-4
		5	1	4ER5BUT1...	16"-20"	1.55	3.1	1.9		

M+ Typ



Plattengrösse		Teilung	Konus	Zähne	Bestellnummer	Grösse	Abmessungen mm			Unterlegplatte	
IC	L mm	G/Z	IPF		RH		h min	X	Y	RH	Klemmhalter
5/8"	27	5	0.75	2	5ER5BUT752M+...	4 1/2"-13 3/8"	1.55	4.8	6.8	YE5M	AL..-5M

T+ Typ



Plattengrösse		Teilung	Konus	Zähne	Bestellnummer	Grösse	Abmessungen mm			Unterlegplatte	
IC	L mm	G/Z	IPF		RH		h min	X	Y	RH	Klemmhalter
1/2" T	22	5	0.75	3	4ER5BUT753T+...	4 1/2"-13 3/8"	1.55	0.1	16.1	Y4T	AL..-4T

API Buttress Casing

Innen

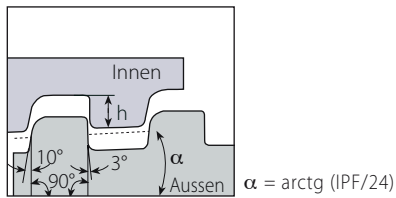

Norm: STD.5B:1979
Toleranzklasse: Standard API

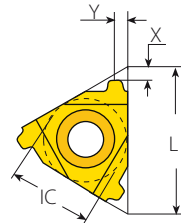

Standard

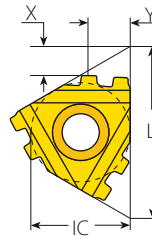

M+ Typ

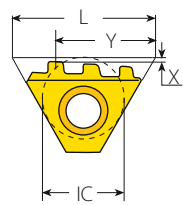

T+ Typ

Standard

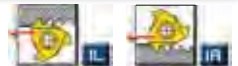

Plattengrösse		Teilung	Konus	Bestellnummer	Grösse	Abmessungen mm			Unterlegplatte	
IC	L mm	G/Z	IPF	RH		h min	X	Y	RH	Klemmhalter
1/2"	22	5	0.75	4IR5BUT75...	4 1/2"-13 3/8"	1.55	2.8	1.9	YI4	AVR..-4
		5	1	4IR5BUT1...	16"-20"	1.55	2.8	1.9		

M+ Typ



Plattengrösse		Teilung	Konus	Zähne	Bestellnummer	Grösse	Abmessungen mm			Unterlegplatte	
IC	L mm	G/Z	IPF		RH		h min	X	Y	RH	Klemmhalter
5/8"	27	5	0.75	2	5IR5BUT752M+...	4 1/2"-13 3/8"	1.55	4.8	6.7	YI5M	AVR..-5M

T+ Typ



Plattengrösse		Teilung	Konus	Zähne	Bestellnummer	Grösse	Abmessungen mm			Unterlegplatte	
IC	L mm	G/Z	IPF		RH		h min	X	Y	RH	Klemmhalter
1/2" T	22	5	0.75	3	4IR5BUT753T+...	4 1/2"-13 3/8"	1.55	0.1	16.1	Y4T	AVR..-4T

API Round Casing & Tubing

Aussen

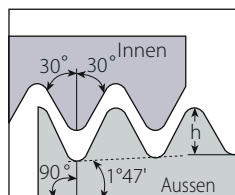

Norm: API STD. 5B:1979
Toleranzklasse: Standard API RD

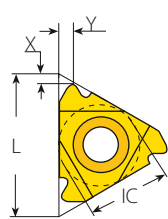

Standard

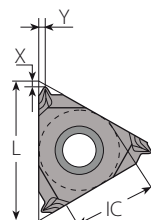

SCB
Gesinterter
Spanbrecher

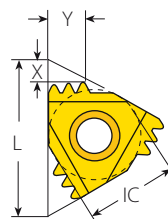

M+ Typ

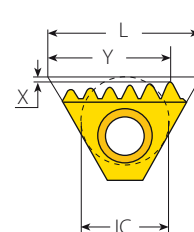

T+ Typ

Standard



SCB

Plattengrösse		Teilung	Bestellnummer		Abmessungen mm			Unterlegplatte	
IC	L mm	G/Z	RH		h min	X	Y	RH	Klemmhalter
3/8"	16	10	3ER10APIRD...		1.41	1.2	1.4	YE3	AL..-3
		8	3ER8APIRD...		1.81	1.3	1.5		
3/8" SCB	16	10	3JER10APIRD...		1.41	1.2	1.5	YE3	AL..-3
		8	3JER8APIRD...		1.81	1.3	1.5		

M+ Typ

Multiplus



Plattengrösse		Teilung	Zähne	Bestellnummer		Abmessungen mm			Unterlegplatte	
IC	L mm	G/Z	RH		h min	X	Y	RH	Klemmhalter	
5/8"	27	10	3	5ER10APIRD3M+...		1.41	3.9	6.3	YE5M	AL..-5M
		8	2	5ER8APIRD2M+...		1.81	2.9	4.5		

T+ Typ

Multiplus



Plattengrösse		Teilung	Zähne	Bestellnummer		Abmessungen mm			Unterlegplatte	
IC	L mm	G/Z	RH		h min	X	Y	RH	Klemmhalter	
1/2"T	22	10	6	4ER10APIRD6T+...		1.41	0.2	16.2	Y4T	AL..-4T
		8	3	4ER8APIRD3T+...		1.81	0.2	14.2		
		8	5	4ER8APIRD5T+...		1.81	0.2	16.7		

API Round Casing & Tubing (Fortsetzung)

Innen

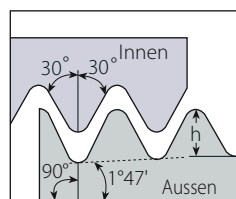

Norm: API STD. 5B:1979
Toleranzklasse: Standard API RD

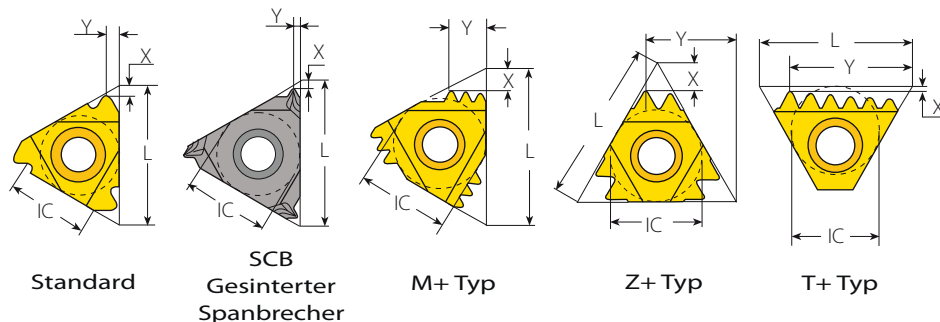

Standard



Plattengröße		Teilung	Bestellnummer		Abmessungen mm			Unterlegplatte	
IC	L mm	G/Z	RH		h min	X	Y	RH	Klemmhalter
3/8"	16	10	3IR10APIRD...		1.41	1.2	1.4	Y13	AVR...-3
		8	3IR8APIRD...		1.81	1.3	1.5		
3/8" SCB	16	10	3JIR10APIRD...		1.41	1.2	1.5	Y13	AVR...-3
		8	3JIR8APIRD...		1.81	1.3	1.5		

M+ Typ



Plattengröße		Teilung	Zähne	Bestellnummer		Abmessungen mm			Unterlegplatte	
IC	L mm	G/Z	RH		h min	X	Y	RH	Klemmhalter	
1/2"	22	10	2	4IR10APIRD2M+...		1.41	2.4	3.7	Y14M	AVR...-4
		8	2	4IR8APIRD2M+...		1.81	2.9	4.5		
5/8"	27	10	3	5IR10APIRD3M+...		1.41	3.9	6.3	Y15M	AVR...-5M
		8	2	5IR8APIRD2M+...		1.81	2.9	4.5		

Z+ Typ



Plattengröße		Teilung	Zähne	Bestellnummer		Abmessungen mm			Unterlegplatte	
IC	L mm	G/Z	RH		h min	X	Y	RH	Klemmhalter	
1/2"	22	8	2	4IR8APIRD2Z+...		1.81	3.7	9.6	Y14Z	AVR...-4Z

T+ Typ



Plattengröße		Teilung	Zähne	Bestellnummer		Abmessungen mm			Unterlegplatte	
IC	L mm	G/Z	RH		h min	X	Y	RH	Klemmhalter	
1/2" ^T	22	10	6	4IR10APIRD6T+...		1.43	0.2	16.8	Y4T	AVR...-4T
		8	3	4IR8APIRD3T+...		1.81	0.2	14.2		
		8	5	4IR8APIRD5T+...		1.81	0.2	16.7		

VAM

Aussen / Innen

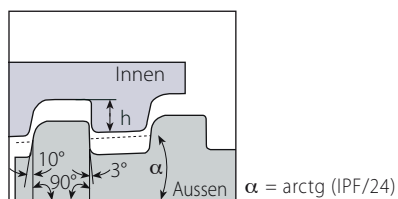

Norm: VAM
Toleranzklasse: Standard VAM

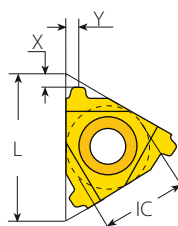

Aussen - Norm

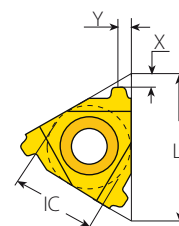

Innen - Norm

Aussen - Standard



Plattengrösse		Teilung	Konus	Bestellnummer	Grösse	Abmessungen mm			Unterlegplatte	
IC	L mm	G/Z	IPF	RH		h min	X	Y	RH	Klemmhalter
3/8"	16	8	0.75	3ER8VAM...	2 3/8", 2 7/8"	0.97	1.7	1.8	YE3	AL...-3
1/2"	22	6	0.75	4ER6VAM...	3 1/2"	0.97	2.4	2.4	YE4	AL...-4
		5	0.75	4ER5VAM...	5"-9 5/8"	1.54	2.4	2.7		

Innen - Standard



Plattengrösse		Teilung	Konus	Bestellnummer	Grösse	Abmessungen mm			Unterlegplatte	
IC	L mm	G/Z	IPF	RH		h min	X	Y	RH	Klemmhalter
3/8"	16	8	0.75	3IR8VAM...	2 3/8", 2 7/8"	0.97	1.7	1.8	YI3	AVR...-3
1/2"	22	6	0.75	4IR6VAM...	3 1/2"	0.97	2.5	2.5	YI4	AVR...-4
		5	0.75	4IR5VAM...	5"-9 5/8"	1.54	2.4	2.5		

EL-Extreme Line

Aussen / Innen

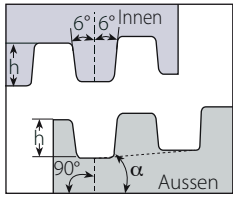

$\alpha = \arctg (IPF/24)$

Norm: API STD,5B:1979
Toleranzklasse: Standard

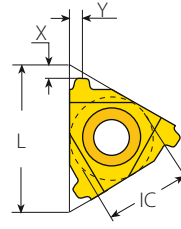

Aussen - Norm

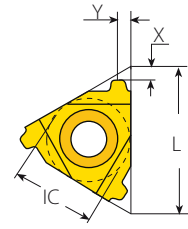

Innen - Norm

Aussen - Standard



Plattengrösse		Teilung	Konus	Bestellnummer	Grösse	Abmessungen mm			Unterlegplatte	
IC	L mm	G/Z	IPF	RH		h min	X	Y	RH	Klemmhalter
1/2"	22	6	1.5	4ER6EL15...	5"-7 5/8"	1.21	1.9	1.9	YE4	AL...-4 (LH)
		5	1.25	4ER5EL125...	8 5/8"-10 3/4"	1.71	2.3	2.4		

Innen - Standard



Plattengrösse		Teilung	Konus	Bestellnummer	Grösse	Abmessungen mm			Unterlegplatte	
IC	L mm	G/Z	IPF	RH		h min	X	Y	RH	Klemmhalter
1/2"	22	6	1.5	4IR6EL15...	5"-7 5/8"	1.39	1.8	1.9	YI4	AVR...-4 (LH)
		5	1.25	4IR5EL125...	8 5/8"-10 3/4"	1.91	2.2	2.4		

Hughes H-90

Aussen / Innen

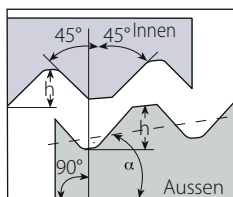

$$\alpha = \arctg (IPF/24)$$

Norm: API STD,5B:1979
Toleranzklasse: Standard

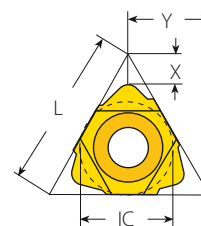

U Typ

U Style - External



Plattengrösse		Teilung	Konus	Bestellnummer	Grösse	Abmessungen mm			Unterlegplatte	
IC	L mm	G/Z	IPF	RH		h min	X	Y	RH	Klemmhalter
1/2" U	22	3.5	2	4UER3.5H902...	3 1/2"-6 5/8"	2.50	4.2	11	YE4U-H90	AL...-4U (LH)
		3.5	3	4UER3.5H903...	7"-8 5/8"	2.50	4.2	11		
5/8" U	27	3	1.25*	5UER3H90SL...	2 3/8"-3 1/2"	2.24	5.5	13.7	YE5U-H90	AL...-5U (LH)

* H-90 Slimline

U Typ - Innen



Plattengrösse		Teilung	Konus	Bestellnummer	Grösse	Abmessungen mm			Unterlegplatte	
IC	L mm	G/Z	IPF	RH		h min	X	Y	RH	Klemmhalter
1/2" U	22	3.5	2	4UIR3.5H902...	3 1/2"-6 5/8"	2.50	4.2	11	YI4U-H90	AVR...-4U (LH)
		3.5	3	4UIR3.5H903...	7"-8 5/8"	2.50	4.2	11		
5/8" U	27	3	1.25*	5UIR3H90SL...	2 3/8"-3 1/2"	2.24	5.5	13.7	YI5U-H90	AVR...-5U (LH)

* H-90 Slimline

Pg

Aussen / Innen

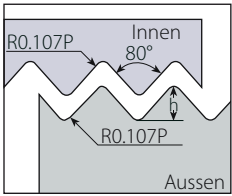

Norm: DIN 40430
Toleranzklasse: Standard

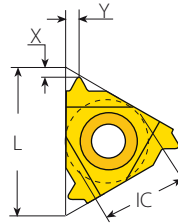

Aussen Standard

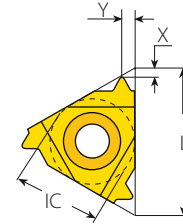

Innen Standard

Aussen - Standard



Plattengrösse		Teilung	Gewinde	Bestellnummer		Abmessungen mm			Unterlegplatte		
IC	L mm	G/Z		RH	LH	h min	X	Y	RH	LH	Klemmhalter
1/4"	11	20	Pg7	2ER20PG...	2EL20PG...	0.61	0.8	0.9	-	-	NL..-2 (LH)
		18	Pg9/11/13.5/16	2ER18PG...	2EL18PG...	0.67	0.8	1.0			
		16	Pg21/29/36/42/48	2ER16PG...	2EL16PG...	0.76	0.9	1.1			
3/8"	16	20	Pg7	3ER20PG...	3EL20PG...	0.61	0.8	0.9	YE3	YI3	AL..-3 (LH)
		18	Pg9/11/13.5/16	3ER18PG...	3EL18PG...	0.67	0.8	1.0			
		16	Pg21/29/36/42/48	3ER16PG...	3EL16PG...	0.76	0.9	1.1			

Innen - Standard



Plattengrösse		Teilung	Gewinde	Bestellnummer		Abmessungen mm			Unterlegplatte		
IC	L mm	G/Z		RH	LH	h min	X	Y	RH	LH	Klemmhalter
1/4"	11	20	Pg7	2IR20PG...	2IL20PG...	0.64	0.8	0.9	-	-	NVR..-2 (LH)
		18	Pg9/11/13.5/16	2IR18PG...	2IL18PG...	0.67	0.8	1.0			
		16	Pg21/29/36/42/48	2IR16PG...	2IL16PG...	0.76	0.9	1.1			
3/8"	16	20	Pg7	3IR20PG...	3IL20PG...	0.64	0.8	0.9	YI3	YE3	AVR..-3 (LH)
		18	Pg11/13.5/16	3IR18PG...	3IL18PG...	0.67	0.8	1.0			
		16	Pg21/29/36/42/48	3IR16PG...	3IL16PG...	0.76	0.8	1.1			

Pg



Innen

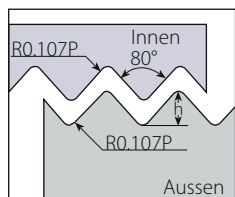

Norm: DIN 40430
Toleranzklasse: Standard

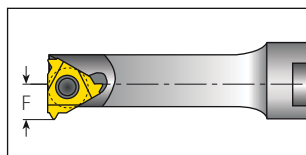
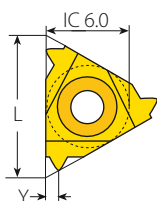

Mini3-Gewinde

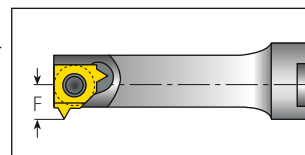
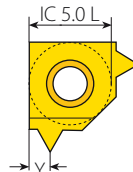

Mini-L-Gewinde

Mini-3 - Gewinde



Plattengröße		Teilung	Gewinde	Bestellnummer	Abmessungen mm			Min. Bohrungsdurchmesser	Klemmhalter
IC	L mm	G/Z		RH	h min	Y	F	mm	
6.0	10	20	Pg7	6.0IR20PG...	0.61	0.8	5.3	10.0	.NVR1..-6.0
		18	Pg9/11/13.5/16	6.0IR18PG...	0.67	0.9	5.3		

Mini-L - Gewinde



Plattengröße		Teilung	Gewinde	Bestellnummer	Abmessungen mm			Min. Bohrungsdurchmesser	Klemmhalter
IC		G/Z		RH	h min	Y	F	mm	
5.0L		20	Pg7	5LIR20PG...	0.61	0.8	4.65	8.0	.NVR10..-5L
		18	Pg9/11/13.5/16	5LIR18PG...	0.67	0.9	4.65		



Gewindedrehen



> Klemmhalter

■ Vardex Bestellnummernsystem.....	Seite 99
------------------------------------	----------

Klemmhalter für die Aussenbearbeitung

■ Standard.....	Seite 100
■ Standard mit Spannfinger.....	Seite 101
■ API.....	Seite 101
■ U typ.....	Seite 102
■ U Typ mit Spannfinger.....	Seite 102
■ Slim Throat.....	Seite 103
■ V typ.....	Seite 104
■ Z+ typ.....	Seite 104
■ M+ typ.....	Seite 105
■ T+ typ.....	Seite 105
■ Versetzter Kopf (FQ).....	Seite 106
■ Abgekröpfter Kopf (CQ).....	Seite 106
■ Miniaturhalter mit rechteckigem Schaft (Klemmhalter für die Aussen- und Innenbearbeitung).....	Seite 107
■ Miniaturhalter mit rundem Schaft (Klemmhalter für die Aussen- und Innenbearbeitung).....	Seite 107

Klemmhalter für die Innenbearbeitung

■ Standard.....	Seite 108
■ Standard für V6.....	Seite 109
■ Standard für Regelgewinde.....	Seite 110
■ U typ für Regelgewinde.....	Seite 110
■ Standard mit Spannfinger.....	Seite 111
■ U typ.....	Seite 111
■ U Typ mit Spannfinger.....	Seite 112
■ V typ.....	Seite 112
■ Z+ typ.....	Seite 113
■ M+ typ.....	Seite 113
■ T+ typ.....	Seite 114
■ API.....	Seite 114
■ Bohrstangen mit Hartmetallschaft.....	Seite 115
■ Gewindedrehsets.....	Seite 116
■ Mini-3-Thread.....	Seite 118
■ Mini-3 verstellbar.....	Seite 118
■ Mini-L-Thread.....	Seite 119
■ Mini-L-Thread verstellbar.....	Seite 119
■ Micro - Zweiseitig.....	Seite 120
■ Micro - Einseitig.....	Seite 121
■ Microscope Sets.....	Seite 122
■ Ersatzteile.....	Seite 123

Vardex Bestellnummernsystem

Klemmhalter für die Aussenbearbeitung

A	L	32	-	4	U	C			
1	2	3		4	5	6	7	8	9

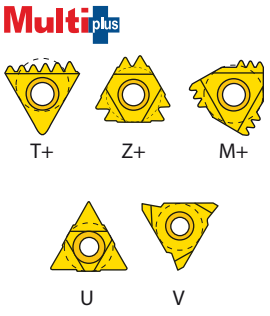
1 - Unterlegplatte A - Unterlegplatte erforderlich N - Ohne Unterlegplatte O - Miniaturhalter	2 - Halter L - Aussen V - Miniaturhalter mit rechteckigem Schaft V - Miniaturhalter mit rundem Schaft	3 - Schaftquerschnitt [mm] 8, 10, 12, 16, 20, 25, 32, 40, 50, 60	4 - Plattengrösse 2 - IC1/4" 3 - IC3/8" 4 - IC1/2" 5 - IC5/8"
5 - Plattentyp 	6 - Spannfinger C - mit Spannfinger	7 - Plattenbreite (für IC5/8"V) 6, 8, 10	
8 - Werkzeug CQ - abgekröpfter Kopf FQ - versetzter Kopf Oil - für API Platten	9 - RH/LH Leer - Rechts LH - Links		

Klemmhalter für die Innenbearbeitung

C	A	VR	C	20		-	3					
1	2	3	4	5	6		7	8	9	10	11	12

1 - Schaft B - Antivibrationssystem C - Hartmetallschaft S - Mini-halter	2 - Unterlegplatte A - Unterlegplatte erforderlich N - Ohne Unterlegplatte O - Miniaturhalter	3 - Werkzeug VR - Runder Schaft, innen	5 - Werkzeugdurchmesser 10, 10D, 12, 13, 16 16D, 20, 25, 25D, 32, 40, 50 6.2 (Mini Adjust) 8.0 (Mini Adjust)	6 - Halterlänge (Mini-Halter) U - Ultra kurz S - Kurz M - Mittel L - Lang T - Verstellbar
7 - Plattengrösse 5L - IC5.0L mm 4.0K - IC4.0 mm 6.0 - IC6.0 mm 2 - IC1/4" 3 - IC3/8" 4 - IC1/2" 5 - IC5/8"	8 - Plattentyp U V T M Z L	9 - Spannfinger C - mit Spannfinger	4 - Kühlung C - mit Kühlkanal	
		10 - Erdölgewinde Oil - für API Platten	11 - RH/LH Leer - Rechts LH - Links	12 - Konstruktionsnummer 156/... (Halter für Regelgewinde) 206/... (V6 Halter)

Micro, Microscope & verstellbare Klemmhalter (Hülsen)

S	M	C	16	-	3
1	2	3	4		5

1 - Halterform S - Hülse (Zweiseitig) M - Microscope (Einseitig)	2 - Halter V - Verstellbare Halter für Mini M - Micro (Zweiseitig) H - Microscope Halter (Einseitig)	3 - Kühlung C - Kühlkanal	4 - Spanndurchmesser 10, 12, 16, 20	5 - Bohrungsgrösse Spanndurchmesser 3, 4, 5, 6, 7, 8, 10 Verstellbare Halter (für Mini) 6.2 8
---	--	-------------------------------------	---	---

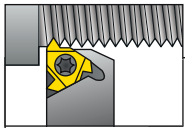

Klemmhalter für die Aussenbearbeitung

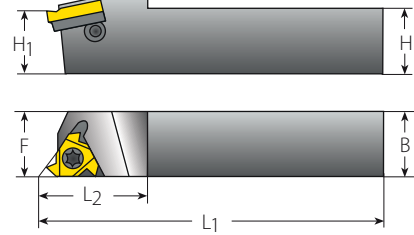

AL...-3 Klemmhalter sind mit Standardunterlegplatten (siehe Ersatzteiltabelle) ausgestattet. Für V6-Gewindeschneidplatten verwenden Sie die V6-Unterlegplatte YE3-6C. Weitere Informationen finden Sie auf Seite 131.

Standard

Ersatzteile

Plattengröße		Bestellnummer				Abmessungen mm					Ersatzteile				
IC	RH/LH	H=H1=B	F	L1	L2	Klemmschraube	Schraube f. U-Platte	Torx Schlüssel	Unterlegplatte RH	Unterlegplatte LH					
1/4"	NL8-2	8	11	136.4	17.5	SN2T	-	K2T	-	-					
	NL10-2	10	11	70	17.5										
	NL12-2	12	12	80	17.5										
3/8"	NL12-3	12	16	83.2	22	SA3T	-	K3T	-	-					
	AL3/8-3	9.52	16	63.6	20.5										
	AL12-3	12	16	83.2	22										
	AL16-3	16	16	100.0	20.5										
	AL20-3	20	20	128.6	30										
	AL25-3	25	25	153.6	30										
1/2"	AL32-3	32	32	173.6	30	SA4T	SY4T	K4T	YE4	Y14					
	AL25-4	25	25	155.7	36										
	AL32-4	32	32	175.7	36										
5/8"	AL40-4	40	40	205.7	36	SA5T	SY5T	K5T	YE5	Y15					
	AL25-5	25	32	151.6	35										
	AL32-5	32	32	176.6	40										
	AL40-5	40	40	206.6	40										
	AL50-5	50	50	256.6	40										

Die oben aufgeführten Klemmhalter besitzen einen Teilungswinkel von 1.5°. Andere Teilungswinkel auf Seite 131. Klemmhalter mit Präfix "N" werden ohne Unterlegplatte benutzt.

Klemmhalter für die Aussenbearbeitung

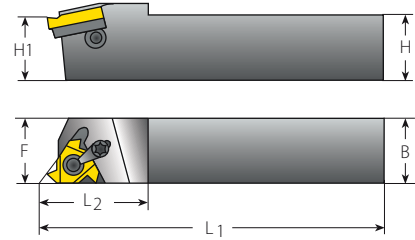
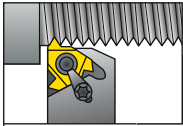

AL...-3 Klemmhalter sind mit Standardunterlegplatten (siehe Ersatzteiltabelle) ausgestattet. Für V6-Gewindeschneidplatten verwenden Sie die V6-Unterlegplatte YE3-6C. Weitere Informationen finden Sie auf Seite 131.

Standard mit Spannfinger

(Duales System, Schraube und Spannfinger)

Ersatzteile

Plattengröße	Bestellnummer	Abmessungen mm									
IC	RH/LH	H=H1=B	F	L1	L2	Klemmschraube	Schraube f. U-Platte	Spannfinger	Torx Schlüssel	Unterlegplatte RH	Unterlegplatte LH
3/8"	AL16-3C	16	16	100.0	20.5	SA3T	SY3T	C3	K3CT	YE3	YI3
	AL20-3C	20	20	128.6	30						
	AL25-3C	25	25	153.6	30						
	AL32-3C	32	32	173.6	30						
1/2"	AL25-4C	25	25	155.7	36	SA4T	SY4T	C4	K4T	YE4	YI4
	AL32-4C	32	32	175.7	36						
	AL40-4C	40	40	205.7	36						
5/8"	AL25-5C	25	32	151.6	35	SA5T	SY5T	C5	K5T	YE5	YI5
	AL32-5C	32	32	176.6	40						
	AL40-5C	40	40	206.6	40						
	AL50-5C	50	50	256.6	40						

Klemmhalter für die Aussenbearbeitung

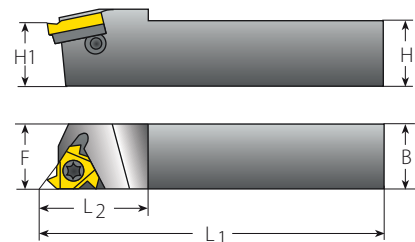
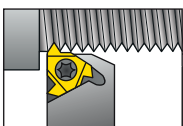

Standard für API

Ersatzteile

Plattengröße	Bestellnummer	Gewindeform	Mutternummer od. Grösse	Abmessungen mm							
IC	RH/LH			H=H1=B=F	L1	L2	Klemmschraube	Schraube f. U-Platte	Torx Schlüssel	Unterlegplatte RH	Unterlegplatte LH
5/8"	AL32-5OIL	V0.038R	V0.050 NC23-NC77 all sizes	32	175.9	40	SA5T	SY5T	K5T	YE5OIL	YI5OIL
	AL40-5OIL	V0.038R	V0.050 NC23-NC77 all sizes	40	205.9	40					

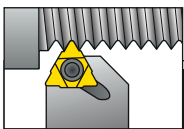

Klemmhalter für die Aussenbearbeitung

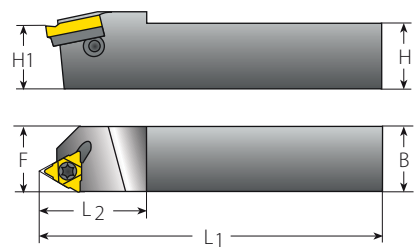

U Typ

Plattengrösse		Bestellnummer				Abmessungen mm					Ersatzteile				
IC	RH/LH	H=H1=B	F	L1	L2	Klemmschraube	Schraube f. U-Platte	Torx Schlüssel	Unterlegplatte RH	Unterlegplatte LH					
1/2"U	AL25-4U	25	25	178.4	38	SA4T	SY4T	K4T	YE4U	YI4U					
	AL32-4U	32	32	178.4	38										
	AL40-4U	40	40	208.4	38										
5/8"U	AL25-5U	25	25	179.1	40	SA5T	SY5T	K5T	YE5U	YI5U					
	AL32-5U	32	32	179.1	40										
	AL40-5U	40	40	209.1	40										
	AL50-5U	50	50	259.1	40										

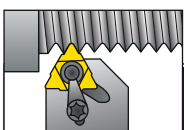

Klemmhalter für die Aussenbearbeitung

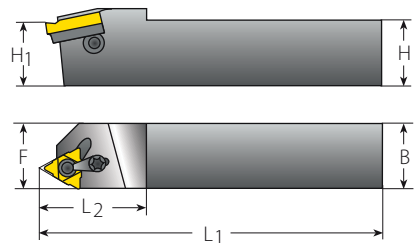

U Typ mit Spannfinger

(Duales System, Schraube und Klammer)

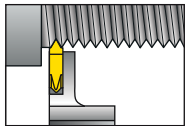

Plattengrösse		Bestellnummer				Abmessungen mm						Ersatzteile					
IC	RH/LH	H=H1=B	F	L1	L2	Klemmschraube	Schraube f. U-Platte	Spannfinger	Torx Schlüssel	Unterlegplatte RH	Unterlegplatte LH						
1/2"U	AL32-4UC	32	32	178.4	38	SA4T	SY4T	C4	K4T	YE4U	YI4U						
	AL40-4UC	40	40	208.4	38												
	AL32-5UC	32	32	179.1	40												
5/8"U	AL40-5UC	40	40	209.1	40	SA5T	SY5T	C5	K5T	YE5U	YI5U						
	AL50-5UC	50	50	259.1	40												

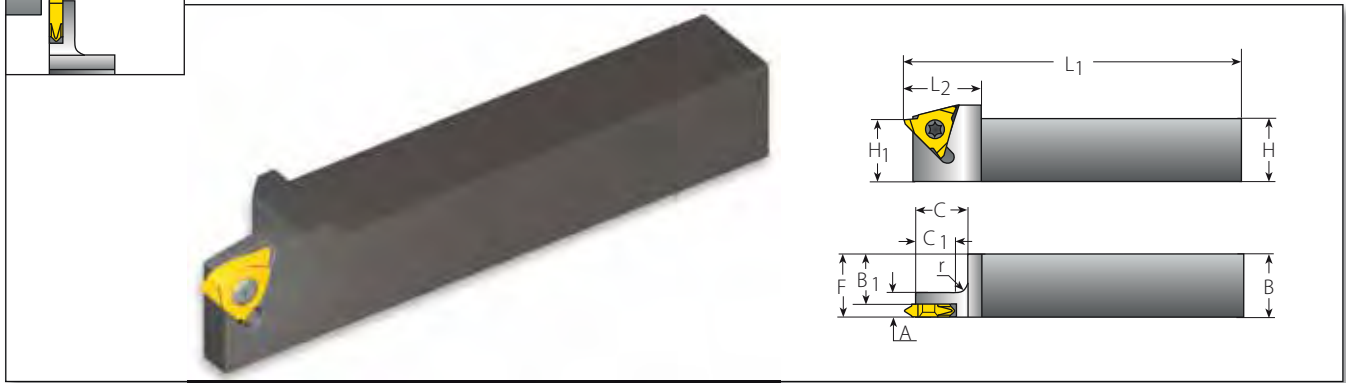

Klemmhalter für die Aussenbearbeitung



Slim Throat

Plattengröße		Abmessungen mm									Ersatzteile	
IC	RH/LH	H=B=F	H1	A	B1	C	C1	L1	L2	r		
1/4"V	NL8-2V	8	10	7	4.8	12.5	11.5	60	14.0	1	SN2T	K2T
	NL10-2V	10	10	7	6.8	12.5	11.5	70	14.0	1		
	NL12-2V	12	12	7	8.8	14.5	11.5	80	14.0	3		
	NL16-2V	16	16	7	12.8	14.5	11.5	100	14.0	3		
3/8"V	NL10-3V	10	14	7	6.4	14.5	11.5	70	18.5	3	SN3TV	K3T
	NL12-3V	12	14	7	8.4	14.5	11.5	80	18.5	3		
	NL16-3V	16	16	7	12.4	14.5	11.5	100	25.0	3		
	NL20-3V	20	20	7	16.4	16.5	11.5	125	30.0	3		
	NL25-3V	25	25	7	21.4	16.5	11.5	150	30.0	5		
	NL32-3V	32	32	7	28.4	16.5	11.5	170	30.0	5		
1/2"V	NL25-4V	25	25	12	20.2	16.5	11.5	150	30.0	5	SN4T	K4T
	NL32-4V	32	32	12	27.2	16.5	11.5	170	30.0	5		
	NL40-4V	40	40	12	35.2	16.5	11.5	200	30.0	5		

Alle Slim Throat-Klemmhalter besitzen einen Teilungswinkel von 1.5°

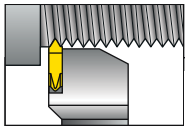

Klemmhalter für die Aussenbearbeitung

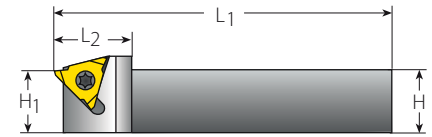

V Typ

Plattengröße		Bestellnummer	Abmessungen mm				Ersatzteile	
IC	RH/LH	H=H1=B	B1	F	L1	L2	Klemmschraube	Torx Schlüssel
5/8"V	NL32-5V-6	32	25.5	32.0	170	40	SN6T	K6T
	NL32-5V-8	32	25.5	34.1	170	40		
	NL32-5V-10	32	25.5	35.8	170	40		
	NL32-5V-10ABUT*	32	25.5	35.8	170	40		
	NL40-5V-6	40	33.5	40.0	200	40		
	NL40-5V-8	40	33.5	42.1	200	40		
	NL40-5V-10	40	33.5	43.8	200	40		
NL40-5V-10ABUT*	40	33.5	43.8	200	40			

Alle Klemmhalter des Typs V besitzen einen Teilungswinkel von 1°.

Die oben aufgeführten Klemmhalter sind für RH-Platten. Bei LH-Platten fügen Sie bitte LH an die Bestellnummer des Klemmhalters an (Beispiel NL32-5V-6 **LH**), nur verwendbar mit Schneidplatte 5VER2.5ABUT...

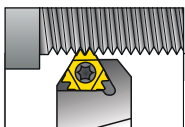

Klemmhalter für die Aussenbearbeitung

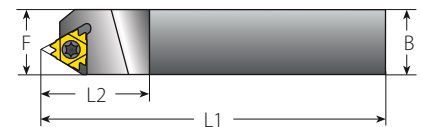

Z+ Typ

Plattengröße		Bestellnummer	Abmessungen mm				Ersatzteile				
IC	RH	H=H1=B	F	L1	L2	Klemmschraube	Schraube f. U-Platte	Torx Schlüssel	Unterlegplatte RH	Unterlegplatte LH	
1/2"Z	AL32-4Z	32	32	178.4	38	SA4T	SY4T	K4T	YE4Z	YI4Z	
	AL40-4Z	40	40	208.4	38						
5/8"Z	AL32-5Z	32	32	179.1	40	SA5T	SY5T	K5T	YE5Z	YI5Z	
	AL40-5Z	40	40	209.1	40						
	AL50-5Z	50	50	259.1	40						

Alle Klemmhalter des Typs Z besitzen einen Teilungswinkel von 1.5°.



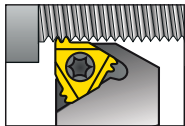

Klemmhalter für die Aussenbearbeitung

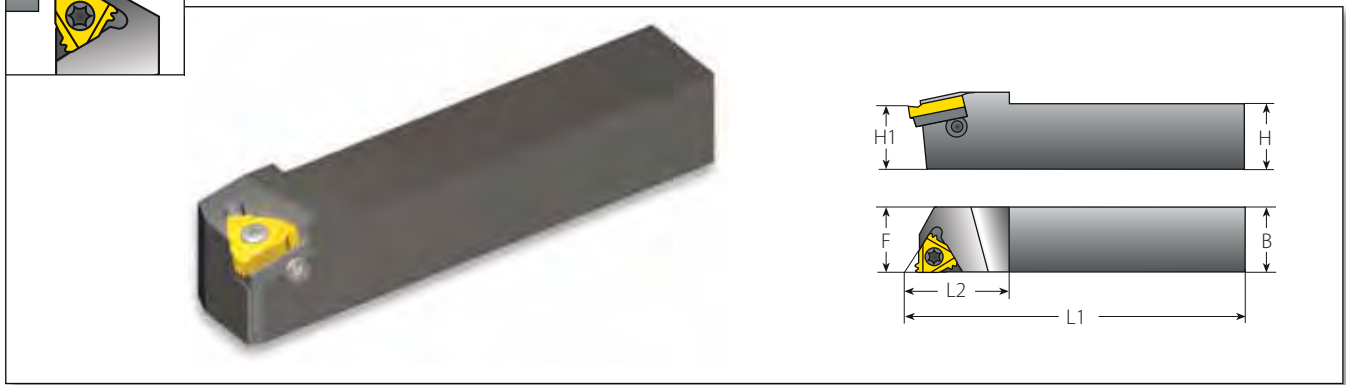

M+ Typ

Plattengröße		Bestellnummer				Abmessungen mm					Ersatzteile				
IC	RH	H=H1=B	F	L1	L2	Klemmschraube	Schraube f. U-Platte	Torx Schlüssel	Unterlegplatte RH	Unterlegplatte LH					
5/8"M	AL32-5M	32	32	176.6	40	SA5T	SY5T	K5T	YE5M	YI5M					
	AL40-5M	40	40	206.6	40										
	AL50-5M	50	50	256.6	40										

Alle Klemmhalter des Typs M besitzen einen Teilungswinkel von 1.5°.

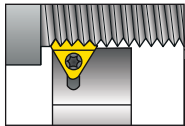

Klemmhalter für die Aussenbearbeitung



T+ Typ

Plattengröße		Bestellnummer				Abmessungen mm					Ersatzteile				
IC	RH	H=H1=B	F	L1	L2	Klemmschraube	Schraube f. U-Platte	Schlüssel f. WSP	Schlüssel f. U-Platte	Unterlegplatte RH/LH					
1/2"T	AL25-4T	25	27	150	30	SA4T	SY4K2	K4T	K2	Y4T					
	AL32-4T	32	34	170	30										
	AL40-4T	40	42	200	30										

Alle Klemmhalter des Typs T besitzen einen Teilungswinkel von 0°.

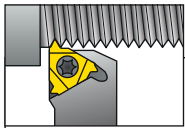

Klemmhalter für die Aussenbearbeitung

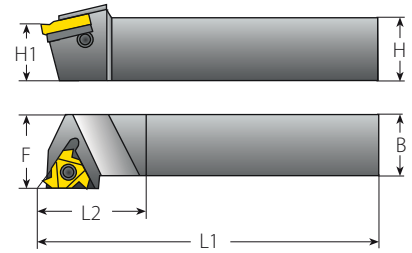

AL..-3 Klemmhalter sind mit Standardunterlegplatten (siehe Ersatzteiltabelle) ausgestattet. Für V6-Gewindeschneidplatten verwenden Sie die V6-Unterlegplatte YE3-6C. Weitere Informationen finden Sie auf Seite 131.

Versetzter Kopf (FQ)

Plattengröße		Bestellnummer		Abmessungen mm			Ersatzteile				
IC	RH/LH	H=H1=B	F	L1	L2	Klemmschraube	Schraube f. U-Platte	Torx Schlüssel	Unterlegplatte RH	Unterlegplatte LH	
3/8"	AL20-3FQ	20	25	125	25	SA3T	SY3T	K3T	YE3	YI3	
	AL25-3FQ	25	32	150	25						
	AL32-3FQ	32	40	170	32						
1/2"	AL25-4FQ	25	32	150	30	SA4T	SY4T	K4T	YE4	YI4	
	AL32-4FQ	32	40	170	30						
5/8"	AL32-5FQ	32	40	170	35	SA5T	SY5T	K5T	YE5	YI5	

AL-3 Klemmhalter sind mit Standard unterlegplatten (siehe Ersatzteiltabelle) ausgestattet. Für V6-Schneidplatten verwenden Sie die V6-Unterlegplatte YE3-6C. Weitere Informationen finden Sie auf Seite 131.

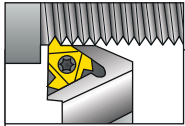

Klemmhalter für die Aussenbearbeitung

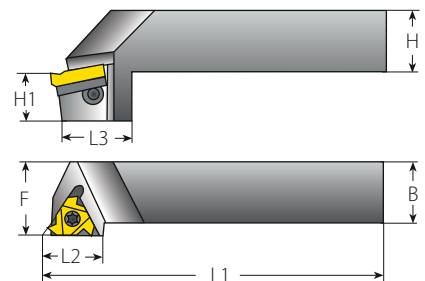

AL..-3 Klemmhalter sind mit Standardunterlegplatten (siehe Ersatzteiltabelle) ausgestattet. Für V6-Gewindeschneidplatten verwenden Sie die V6-Unterlegplatte YE3-6C. Weitere Informationen finden Sie auf Seite 131.

Abgekröpfter Kopf (CQ)

Plattengröße		Bestellnummer		Abmessungen mm				Ersatzteile				
IC	RH/LH	H=B	F	L1	L2	L3	H1	Klemmschraube	Schraube f. U-Platte	Torx Schlüssel	Unterlegplatte RH	Unterlegplatte LH
3/8"	AL20-3CQ	20	25	125	24	38	17.5	SA3T	SY3T	K3T	YE3	YI3
	AL25-3CQ	25	32	150	24	38	22.2					
	AL32-3CQ	32	40	170	24	38	22.2					
1/2"	AL25-4CQ	25	32	150	30	38	22.2	SA4T	SY4T	K4T	YE4	YI4
	AL32-4CQ	32	40	170	30	38	22.2					
5/8"	AL32-5CQ	32	40	170	33	43	25.4	SA5T	SY5T	K5T	YE5	YI5

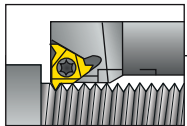

Klemhalter zur Innen-und Aussenbearbeitung

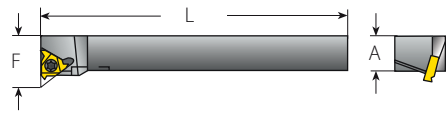

Miniaturhalter mit rechteckigem Schaft*

Ersatzteile

Plattengröße	Bestellnummer	Abmessungen mm				Min. Bohrungsdurchmesser		
IC	RH/LH	A	L	L1	F	mm	Klemmschraube	Torx Schlüssel
1/4"	OV 8-2	8	100	25	12	29.2	SN2T	K2T
	OV 10-2	10	100	25	14	36.1		

Miniatur-Halter besitzen einen Teilungswinkel von 0.5°.

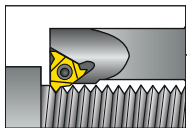

Klemhalter zur Innen-und Aussenbearbeitung



Miniaturhalter mit rundem Schaft*

Ersatzteile

Plattengröße	Bestellnummer	Abmessungen mm						Min. Bohrungsdurchmesser		
IC	RH/LH	A	L	L1	D	D1	F	mm	Klemmschraube	Torx Schlüssel
1/4"	OVR 12-2	11.4	100	25	12	10	7.4	13	SN2T	K2T
	OVR 15-2	14.3	100	32	15	13	8.9	16		
	OVR 16D-2	15.3	100	32	16	13	8.9	16		

Miniatur-Halter besitzen einen Teilungswinkel von 0.5°.

* Miniatur-Halter mit rechteckigem und rundem Schaft wurden für die Nutzung auf automatischen Drehbänken z.B. in der optischen Industrie entwickelt. Sie können sowohl zum Aussen- als auch zum Innengewindedrehen wie folgt verwendet werden:

Gewinde	ER	EL	IR	IL
Platte	ER	EL	IR	IL
Halter	LH	RH	RH	LH

Die oben aufgeführten Klemhalter sind für RH-Platten. Bei LH-Platten fügen Sie bitte LH an die Bestellnummer des Klemhalters an (Beispiel OV 8-2 LH).

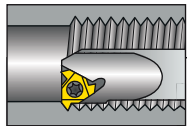

Klemmhalter für die Innenbearbeitung

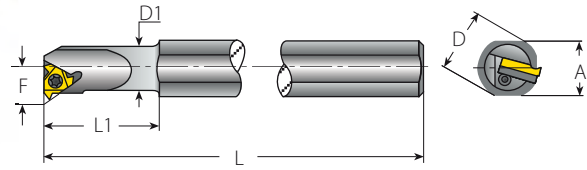

AVR..-3 Klemmhalter sind mit Standardunterlegplatten (siehe Ersatzteiltabelle) ausgestattet. Für V6-Gewindeschneidplatten verwenden Sie die V6-Unterlegplatte Y13-6C. Weitere Informationen finden Sie auf Seite 131.

Standard

Ersatzteile

Plattengröße Bestellnummer		Abmessungen mm						Min. Bohrungsdurchmesser					
IC	RH/LH	A	L	L1	D	D1	F	mm	Klemmschraube	Schraube f. U-Platte	Torx Schlüssel	Unterlegplatte RH	Unterlegplatte LH
1/4"	NVR10D-2	100	180	25	20	10.0	7.3	13	-	-	-	-	-
	NVR10-2	18.0	180	25	20	10.0	7.3	13	SN2T	-	K2T	-	-
	NVR13-2	18.0	180	32	20	13.0	8.9	16	-	-	-	-	-
3/8"	NVR13-3	18.0	180	32	20	12.7	10.3	17	-	-	-	-	-
	NVR16-3	18.0	180	40	20	16.0	11.5	20	SN3T	-	K3T	-	-
	NVR16D-3	15.2	150	32	16	16.0	11.3	20	-	-	-	-	-
	AVR20-3	18.0	180	40	20	20.0	13.4	24	-	-	-	-	-
	AVR25-3	29.0	250	60	32	25.0	16.3	29	-	-	-	-	-
	AVR25D-3	22.6	200	45	25	24.6	16.1	29	SA3T	SY3T	K3T	Y13	YE3
1/2"	AVR32-3	29.0	250	60	32	32.0	19.6	36	-	-	-	-	-
	AVR40-3	36.0	300	60	40	40.0	23.8	44	-	-	-	-	-
	NVR20-4	18.0	180	50	20	20.0	15.6	27	SN4T	-	K4T	-	-
	AVR25-4	29.0	250	60	32	25.0	17.4	32	-	-	-	-	-
	AVR25D-4	22.6	200	45	25	24.6	17.2	32	-	-	-	-	-
	AVR32-4	29.0	250	60	32	32.0	21.5	39	SA4T	SY4T	K4T	Y14	YE4
5/8"	AVR40-4	36.0	300	60	40	40.0	25.8	47	-	-	-	-	-
	AVR50-4	45.0	350	75	50	50.0	30.8	57	-	-	-	-	-
	AVR32-5	29.0	250	60	32	32.0	22.4	40	SN5T	SY5T	K5T	Y15	YE5
	AVR40-5	36.0	300	60	40	40.0	26.4	48	-	-	-	-	-
	AVR50-5	45.0	350	75	50	50.0	31.4	58	SA5T	SY5T	K5T	Y15	YE5
	AVR60-5	54.0	400	75	60	60.0	36.4	69	-	-	-	-	-

Die oben aufgeführten Klemmhalter besitzen einen Steigungswinkel von 1.5°. Andere Steigungswinkel auf Seite 131.
Klemmhalter mit Präfix "N" werden ohne Unterlegplatte benutzt.
Halter mit Kühlkanal sind als Standard erhältlich (Beispiel NVRC 10D-2)

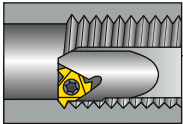

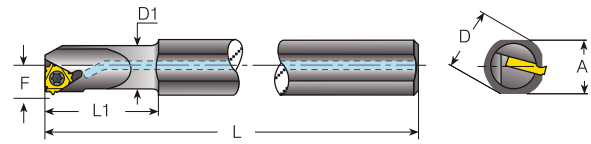

Klemmhalter für die Innenbearbeitung für V6 (ohne Unterlegplatte)*



speziell für V6 Schneidplatten ausgelegt

V6 Typ

Plattengröße	Bestellnummer	Abmessungen mm						Min. Bohrungsdurchmesser mm	Ersatzteile	
		A	L	L1	D	D1	F			
3/8" V6	NVRC 13-3 206/001	18	180	32	20	12.7	10.3	17	SN3TM	K3T
	NVRC 16-3 206/002	18	180	40	20	16	11.5	20	SN3T	
	NVRC 16D-3 206/003	15.2	150	40	16	16	11.3	20		

Die oben aufgeführten Klemmhalter besitzen einen Teilungswinkel von 1.5°

* V6 Schneidplatten können nicht auf Standardbohrstangen ohne Unterlegplatte eingesetzt werden.

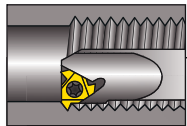

Klemmhalter für die Innenbearbeitung

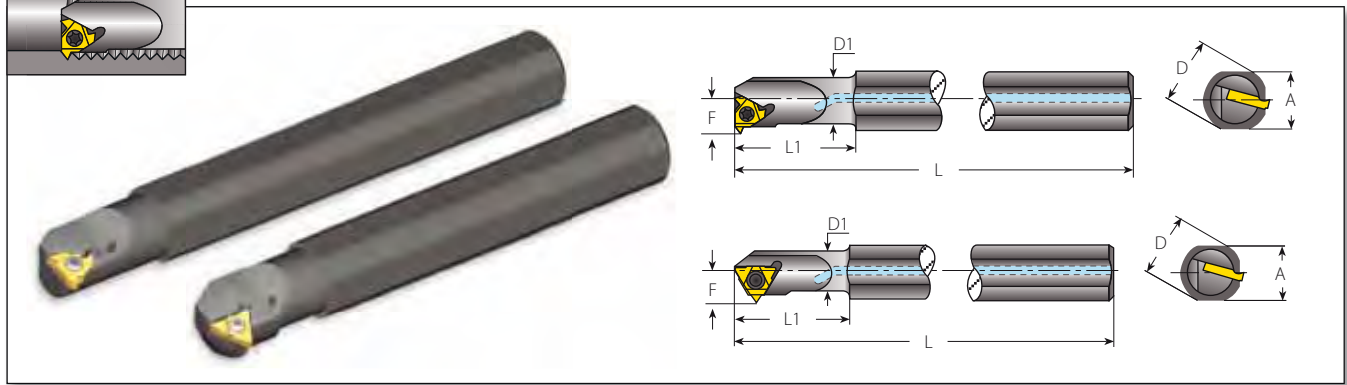

Standard für Regalgewinde

Plattengröße	Bestellnummer	Abmessungen mm					F	Teilungswinkel	Ersatzteile		
		A	L	L1	D	D1			mm	Grad	Klemmschraube
1/4"	NVRC10-2	156/001	18.0	180	25.0	20	10.1	6.53	3.0	SN2T	K2T
	NVRC11-3	156/005	18.0	180	25.4	20	11.2	8.30	4.5	SN3TM	K3T
3/8"	NVRC13-3	156/006	18.0	180	32.0	20	13.0	9.05	4.0	SN3T	K3T
	NVRC13-3	156/016	18.0	180	34.0	20	13.8	8.90	2.5		
1/2"	NVRC17-4	156/007	18.0	180	40.0	20	16.7	11.45	4.0	SN4TM	K4T
	NVRC20-4	156/008	18.0	180	50.0	20	19.6	12.55	3.5	SN4T	K4T
	NVRC20-4	156/009	18.0	180	50.0	20	19.6	12.55	3.0		
5/8"	NVRC25-5	156/012	29.0	250	60.0	32	25.0	16.78	3.3	SN5TM	K5T
	NVRC28-5	156/010	29.0	250	50.0	32	28.0	17.80	3.5		

U Typ für Regalgewinde

Plattengröße	Bestellnummer	Abmessungen mm					F	Teilungswinkel	Ersatzteile		
		A	L	L1	D	D1			mm	Grad	Klemmschraube
6.0U	NVRC8-6.0U	156/003	18.0	180	24.0	20	8.0	5.86	4.0	SN6MT	K6MT
1/4"U	NVRC10-2U	156/004	18.0	180	32.0	20	10.0	7.40	4.0	SM2T8	K2T
	NVRC11-2U	156/002	18.0	180	32.0	20	11.2	7.30	3.0		
3/8"U	NVRC11-3U	156/020	18.0	180	32.0	20	11.0	8.23	4.5	SN3TM	K3T
	NVRC14-3U	156/018	18.0	180	38.0	20	13.4	9.99	4.5		
	NVRC15-3U	156/019	18.0	180	38.0	20	15.4	10.99	4.0		
1/2"U	NVRC20-4U	156/011	18.0	180	40.0	20	19.2	13.68	4.0	SN4T	K4T
	NVRC25-4U	156/013	29.0	250	60.0	32	25.0	17.63	3.5		
	NVRC32-4U	156/014	29.0	250	60.0	32	29.7	18.76	3.3		
5/8"U	NVRC32-5U	156/015	29.0	250	60.0	32	31.6	20.96	3.2	SA5T	K5T

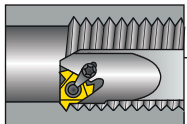

Klemmhalter für die Innenbearbeitung

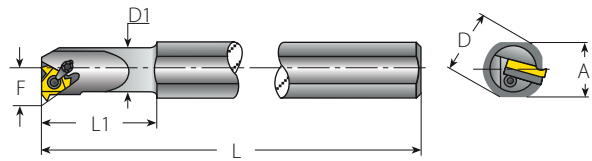
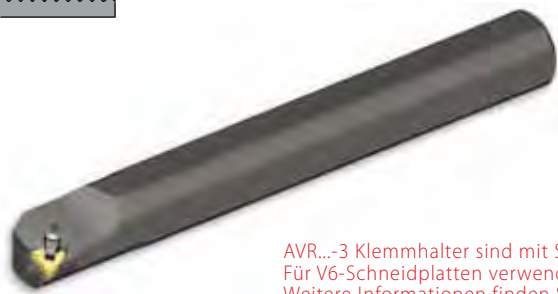

AVR...-3 Klemmhalter sind mit Standard unterlegplatten (siehe Ersatzteiltabelle) ausgestattet
Für V6-Schneidplatten verwenden Sie die V6-Unterlegplatte YE3-6C.
Weitere Informationen finden Sie auf Seite 131.

Standard mit Klammer

(Duales System, Schraube und Klammer)

Ersatzteile

Plattengröße		Bestellnummer							Abmessungen mm		Min. Bohrungsdurchmesser						
IC	RH/LH	A	L	L1	D	D1	F	mm									
3/8"	AVR20-3C	18.0	180	50	20	20.0	13.4	24									
	AVR25-3C	28.0	250	60	32	25.0	16.3	29									
	AVR25D-3C	22.6	200	45	25	24.6	16.1	29	SA3T	SY3T	C3	K3CT	YI3	YE3			
	AVR32-3C	29.0	250	60	32	32.0	19.6	36									
	AVR40-3C	36.0	300	60	40	40.0	23.8	44									
1/2"	AVR25-4C	29.0	250	60	32	25.0	17.4	32									
	AVR25D-4C	22.6	200	45	25	24.6	17.2	32	SA4T	SY4T	C4	K4T	YI4	YE4			
	AVR32-4C	29.0	250	60	32	32.0	21.5	39									
	AVR40-4C	36.0	300	60	40	40.0	25.8	47									
5/8"	AVR32-5C	29.0	250	60	32	32.0	22.4	40	SN5T	SY5T	C5	K5T	YI5	YE5			
	AVR40-5C	36.0	300	60	40	40.0	26.4	48									
	AVR50-5C	45.0	350	75	50	50.0	31.4	58	SA5T	SY5T	C5	K5T	YI5	YE5			
	AVR60-5C	54.0	400	75	60	60.0	36.4	69									

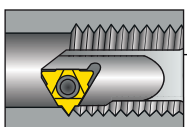

Klemmhalter für die Innenbearbeitung

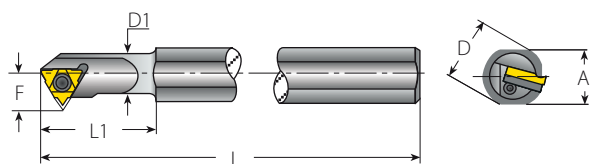

U Typ

Ersatzteile

Plattengröße		Bestellnummer							Abmessungen mm		Min. Bohrungsdurchmesser					
IC	RH/LH	A	L	L1	D	D1	F	mm								
1/2"U	AVR32-4U	29	250	60	32	32	25.5	42	SA4T	SY4T	K4T	YI4U	YE4U			
	AVR40-4U	36	300	60	40	40	29.5	51								
5/8"U	NVR32-5U	29	250	60	32	32	24.7	42	SN5T	-	K5T	-	-			
	AVR40-5U	36	300	60	40	40	29.4	53								
	AVR50-5U	45	350	75	50	50	34.3	63	SA5T	SY5T	K5T	YI5U	YE5U			
	AVR60-5U	54	400	75	60	60	39.3	74								

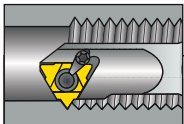

Klemmhalter für die Innenbearbeitung

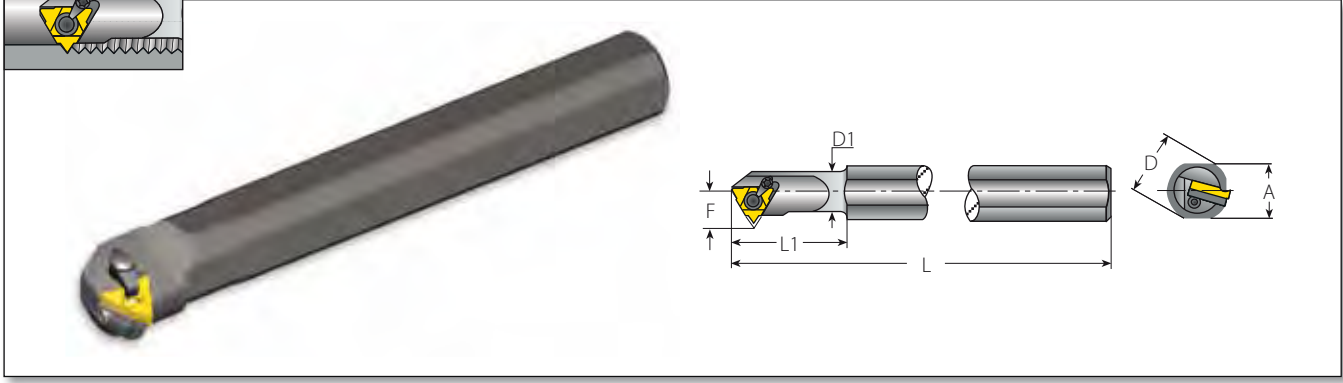

U Typ mit Klammer

(Duales System, Schraube und Klammer)

Ersatzteile

Plattengröße	Bestellnummer	Abmessungen mm						Min. Bohrungsdurchmesser						
IC	RH/LH	A	L	L1	D	D1	F	mm	Klemmschraube	Schraube f. U-Platte	Spannfinger	Torx Schlüssel	Unterlegplatte RH	Unterlegplatte LH
1/2"U	AVR32-4UC	29.0	250	60	32	32.0	25.5	42	SA4T	SY4T	C4	K4T	Y14U	YE4U
	AVR40-4UC	36.0	300	60	40	40.0	29.5	51						
5/8"U	AVR40-5UC	36.0	300	60	40	40.0	29.4	53	SA5T	SY5T	C5	K5T	Y15U	YE5U
	AVR50-5UC	45.0	350	75	50	50.0	34.4	63						
	AVR60-5UC	54.0	400	75	60	60.0	39.3	74						

Die oben aufgeführten Klemmhalter besitzen einen Teilungswinkel von 1.5°. Andere Teilungswinkel auf Seite 131.

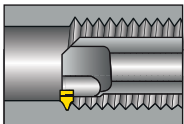

Klemmhalter für die Innenbearbeitung

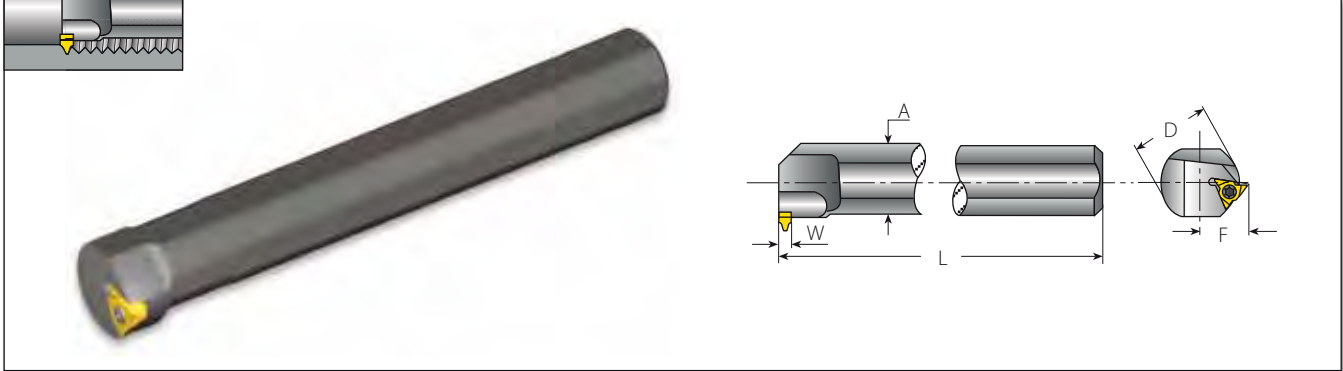

V Typ

Plattengröße	Bestellnummer	Abmessungen mm				
IC	RH/LH	A	L	D	F	W
5/8"V	NVR40-5V	36	300	40	28.4	6.5
	NVR50-5V	45	350	50	33.4	6.5
	NVR60-5V	54	400	60	38.0	6.5

Ersatzteile	
Klemmschraube	Torx Schlüssel
SN6T	K6T

Die oben aufgeführten Klemmhalter besitzen einen Teilungswinkel von 1.0°

Min. Bohrungsdurchmesser

	Teilung mm	6.0 ISO	8.0 ISO	10.0 ISO
	Teilung G/Z	4 UN	3 UN	2.5 W
NVR40-5V	48	54	62	68
NVR50-5V	58	58	62	68
NVR60-5V	68	68	68	68

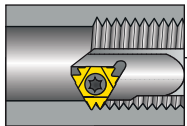

Klemmhalter für die Innenbearbeitung

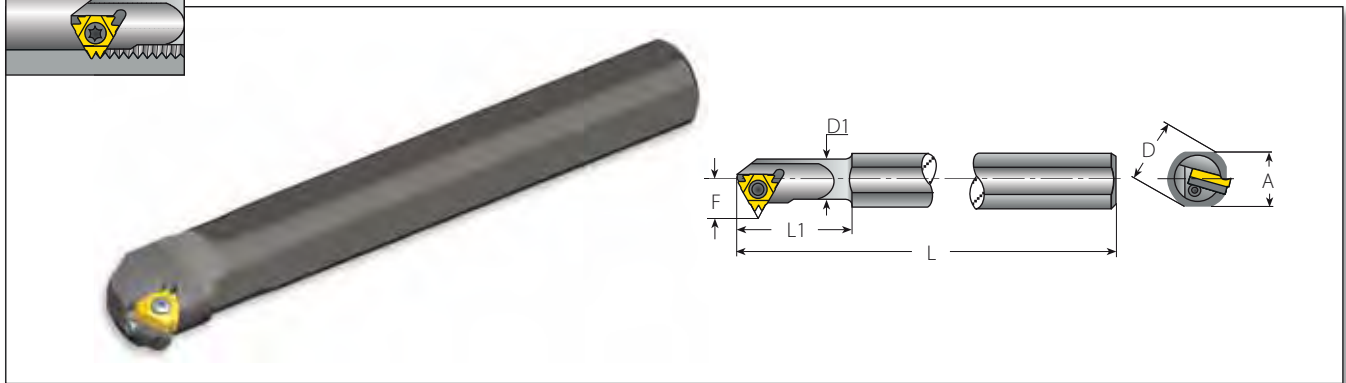

Z+ Typ

Plattengröße	Bestellnummer	Abmessungen mm						Min. Bohrungsdurchmesser	Ersatzteile				
IC		A	L	L1	D	D1	F	mm					
1/2"Z	AVR32-4Z	29	250	60	32	32	25.5	42	SA4T	SY4T	K4T	YI4Z	YE4Z
	AVR40-4Z	36	300	60	40	40	29.5	51					
5/8"Z	NVR32-5Z	29	250	60	32	32	24.7	42	SN5T	-	K5T	-	-
	AVR40-5Z	36	300	60	40	40	29.4	53					
	AVR50-5Z	45	350	75	50	50	34.3	63	SA5T	SY5T	K5T	YI5Z	YE5Z
	AVR60-5Z	54	400	75	60	60	39.3	74					

Alle Klemmhalter des Typs Z besitzen einen Teilungswinkel von 1.5°.

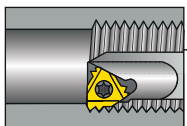

Klemmhalter für die Innenbearbeitung

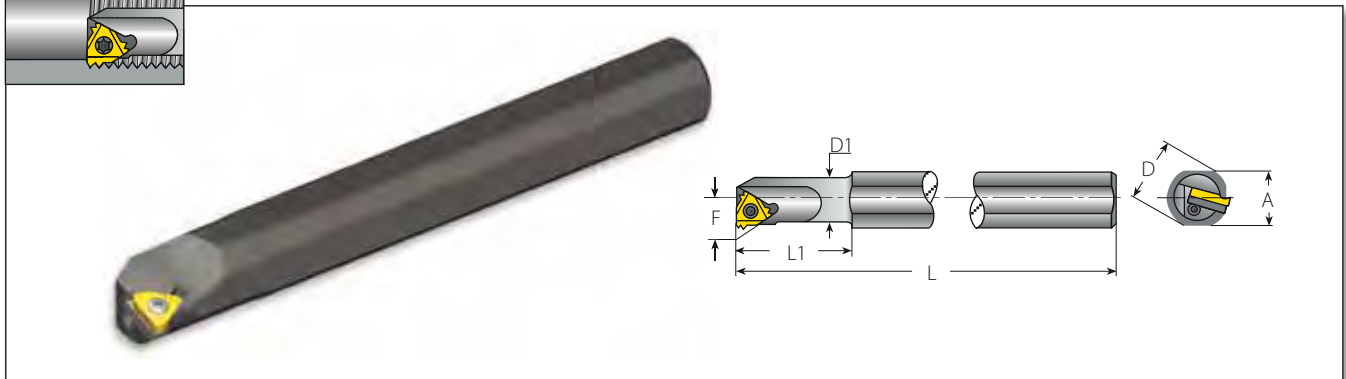

M+ Typ

Plattengröße	Bestellnummer	Abmessungen mm						Min. Bohrungsdurchmesser	Ersatzteile				
IC		A	L	L1	D	D1	F	mm					
5/8"M	AVR32-5M	29	250	60	32	32	22.4	40	SN5T	SY5T	K5T	YI5M	YE5M
	AVR40-5M	36	300	60	40	40	26.4	48					
5/8"M	AVR50-5M	45	350	75	50	50	31.4	58	SA5T	SY5T	K5T	YI5M	YE5M
	AVR60-5M	54	400	75	60	60	36.4	69					

Alle Klemmhalter des Typs M besitzen einen Teilungswinkel von 1.5°.

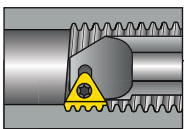

Klemmhalter für die Innenbearbeitung

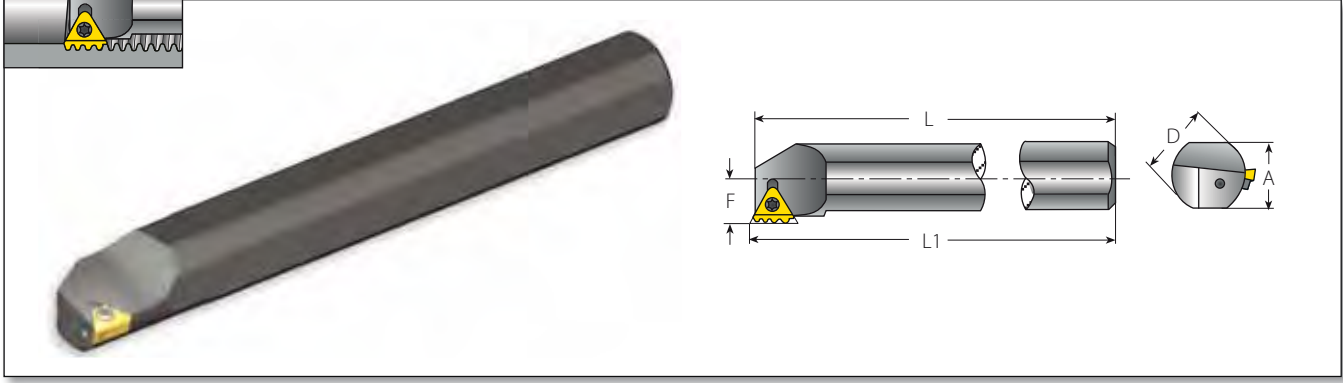

T+ Typ							Ersatzteile Multiplus					
Plattengröße	Bestellnummer	Abmessungen mm					Min. Bohrungsdurchmesser					
IC		A	L	L1	D	F	mm					
1/2" T	AVR40-4T	36	300	302	40	23.3	60					
	AVR50-4T	45	350	352	50	28.3	70	SA4T	SY4K2	K4T	K2	Y4T
	AVR60-4T	54	400	402	60	33.3	80					

Alle Klemmhalter besitzen einen Teilungswinkel von 0°. Halter mit Kühlkanal sind als Standard erhältlich (Beispiel: AVRC-4T)

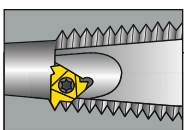

Klemmhalter für die Innenbearbeitung

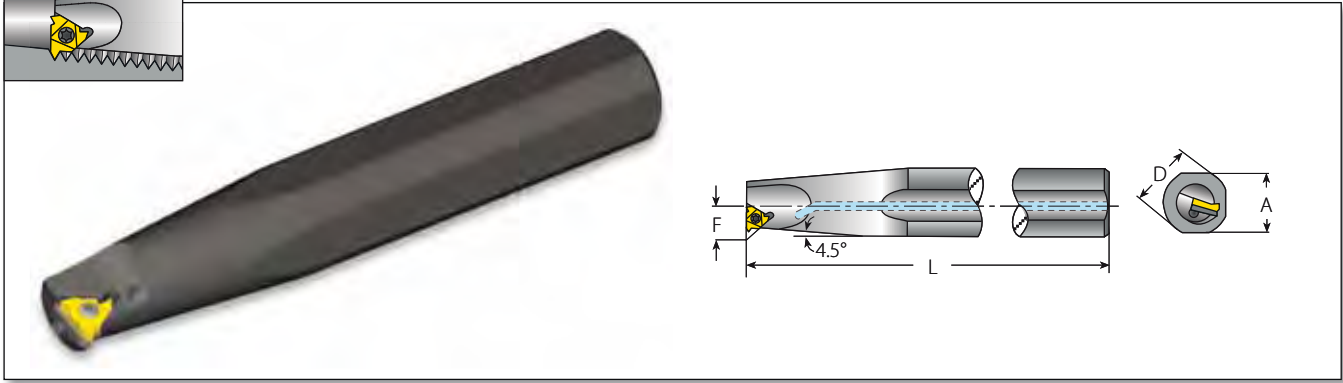

API						Ersatzteile						
Plattengröße	Bestellnummer	Gewindeform	Mutternummer od. Grösse	Abmessungen mm								
IC	RH/LH			A	L	D	F					
5/8"	AVR50-5OIL	V0.038R	NC23-NC38	45	300	50	22.6					
	AVRC50-5OIL	V0.038R	NC23-NC38									
	AVR80-5OIL	V0.050R	NC40-NC77	72	400	80	39.7	SA5T	SY5T	K5T	Y15OIL	YE5OIL
	AVRC80-5OIL	V0.050R	NC40-NC77									

Die oben aufgeführten Klemmhalter besitzen einen Teilungswinkel von 1.5°. Klemmhalter die mit einem internen Kühlkanal bestellt werden, besitzen ein BSP 1/2" Innengewinde zum Anschluss an die flexible Kühlmittelleitung. Die oben aufgeführten Klemmhalter sind für RH-Platten Bei LH-Platten fügen Sie bitte LH an die Bestellnummer des Klemmhalters an (Beispiel AVR50-5OIL LH).

Klemmhalter mit Hartmetallschaft

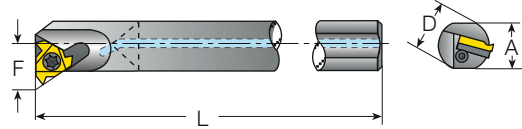
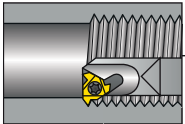

CAVRC...-3 Klemmhalter sind mit Standardunterlegplatten (siehe Ersatzteiltabelle) ausgestattet. Für V6-Gewindeschneidplatten verwenden Sie die V6-Unterlegplatte Y13-6C. Weitere Informationen finden Sie auf Seite 131.

Standard mit Hartmetallschaft

Ersatzteile

Plattengröße	Bestellnummer	Abmessungen mm					Min. Bohrungsdurchmesser	Ersatzteile				
IC	RH/LH	D	A	F	L	mm						
1/4"	CNVRC10-2	10	9.5	7.3	150	13	SN2T	-	K2T	-	-	
	CNVRC12-2	12	11.7	8.3	180	15	-	-	-	-	-	
3/8"	CNVRC16-3	16	15.6	11.5	200	20	SN3T	-	K3T	-	-	
	CAVRC20-3	20	19.5	13.4	250	24	SA3T	SY3T	K3T	Y13	YE3	
1/2"	CNVRC20-4	20	19.5	13.8	250	25	SN4T	-	K4T	-	-	

CAVRC...-3 Klemmhalter sind mit Standardunterlegplatten (siehe Ersatzteiltabelle) ausgestattet

Für V6-Schneidplatten verwenden Sie die V6-Unterlegplatte Y13-6C.

Weitere Informationen finden Sie auf Seite 131.

Klemmhalter mit Hartmetallschaft sollten verwendet werden, wenn höchste Präzision erforderlich ist oder wenn das Verhältnis der Schaftlänge zum Schaftdurchmesser 3:1 übersteigt.

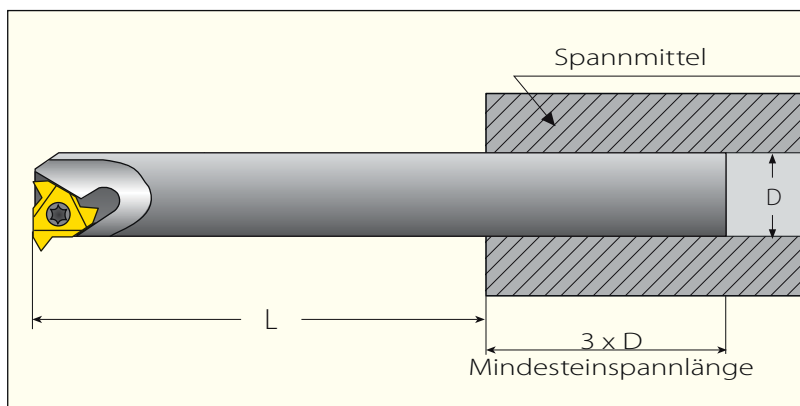

Das Verhältnis von Auskraglänge zu Schaftdurchmesser sollte so klein wie möglich sein, um das Auftreten von Vibrationen auszuschließen. Die min. Spannlänge des Halters in der Klemmvorrichtung sollte das Dreifache Schaftdurchmessers betragen.

Gewindedrehsets *



TT Set für Aussen + Innenbearbeitung



TT Set für Aussenbearbeitung



TT Set für Innenbearbeitung

TT Set für Aussen + Innenbearbeitung

Bestellnummer		Inhalt		
KHTT3EI- ...	Klemmhalter für Aussen- + Innenbearbeitung	10x Aussengewinde-drehplatte	10x Innengewinde-drehplatte	Torx Schlüssel 
	AL 20-3 AVRC 20-3	2ERA60...	3IRA60...	K3T
		2ERA60...	3IRG60...	
		3ER11W...	3IR11W...	
		3ER14W...	3IR14W...	
		3ER1.0ISO...	3IR1.0ISO...	
		3ER1.25ISO...	3IR1.25ISO...	
		3ER1.5ISO...	3IR1.5ISO...	
		3ER2.0ISO...	3IR2.0ISO...	
		3ER2.5ISO...	3IR2.5ISO...	
3ER3.0ISO...	3IR3.0ISO...			

TT Set für Aussenbearbeitung

Bestellnummer		Inhalt	
KHTT3E- ...	Klemmhalter für Aussenbearbeitung	10x Aussengewinde-drehplatte	Torx Schlüssel 
	AL 20-3	2ERA60...	K3T
		2ERA60...	
		3ER11W...	
		3ER14W...	
		3ER1.0ISO...	
		3ER1.25ISO...	
		3ER1.5ISO...	
		3ER2.0ISO...	
		3ER2.5ISO...	
3ER3.0ISO...			

TT Set für Innenbearbeitung

Bestellnummer		Inhalt	
KHTT3I- ...	Klemmhalter für Innenbearbeitung	10x Innengewinde-drehplatte	Torx Schlüssel 
	AVRC 20-3	3IRA60...	K3T
		3IRG60...	
		3IR11W...	
		3IR14W...	
		3IR1.0ISO...	
		3IR1.25ISO...	
		3IR1.5ISO...	
		3IR2.0ISO...	
		3IR2.5ISO...	
3IR3.0ISO...			

Schneidplattensets für Gewindedrehen*





TT Schneidplattenset

TT Set für Aussengewindedrehplatten

Bestellnummer	Inhalt	
KITT3E- ...	10 x Aussengewindedrehplatten	Torx Schlüssel  Klemmschraube 
	2ERA60...	K3T SA3T
	2ERA60...	
	3ER11W...	
	3ER14W...	
	3ER1.0ISO...	
	3ER1.25ISO...	
	3ER1.5ISO...	
	3ER2.0ISO...	
	3ER2.5ISO...	
3ER3.0ISO...		

TT Set für Innengewindedrehplatten

Bestellnummer	Inhalt	
KITT3I- ...	10 x Innengewindedrehplatten	Torx Schlüssel  Klemmschraube 
	3IRA60...	K3T SA3T
	3IRG60...	
	3IR11W...	
	3IR14W...	
	3IR1.0ISO...	
	3IR1.25ISO...	
	3IR1.5ISO...	
	3IR2.0ISO...	
	3IR2.5ISO...	
3IR3.0ISO...		

TT Set für V6-Schneidplatten

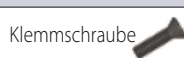
Bestellnummer	Inhalt		
KITT3V6EI- ...	5 x Innengewindedrehplatten	5x Aussengewindedrehplatte	Torx Schlüssel  Klemmschraube 
	3IRS60-6C...	3ERS60-6C...	K3T SA3T
	3IR1.0ISO-6C...	3ER1.0ISO-6C...	
	3IR1.25ISO-6C...	3ER1.25ISO-6C...	
	3IR1.5ISO-6C...	3ER1.5ISO-6C...	
	3IR2.0ISO-6C...	3ER2.0ISO-6C...	



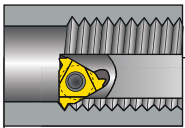

Klemmhalter für die Innenbearbeitung

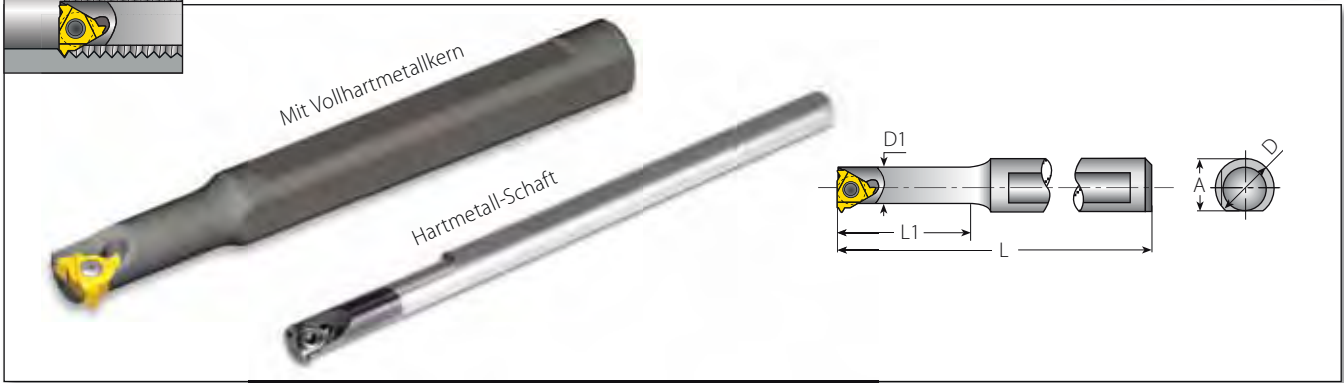

Mini-3 - Gewinde

Plattengröße		Bestellnummer	Abmessungen mm				Dämpfungssystem	Ersatzteile	
IC	RH/LH	A	L	L1	D	D1		Klemmschraube	Torx Schlüssel
4.0	CNVR 5-4.0K	5.2	100	26	6	5.1	Hartmetallschaft	SN4MT	K6MT
	SNVR 5-4.0K	11.0	100	12	12	5.1	ohne		
6.0	SNVR 12U-6.0	11.4	82	16	12	8	ohne	SN6MT	K6MT
	BNVR 10S-6.0	9.4	89	22	10	8	mit Hartmetallkern		
	BNVR 10M-6.0	9.4	98	31	10	8	mit Hartmetallkern		
	BNVR 10L-6.0	9.4	110	43	10	8	mit Hartmetallkern		

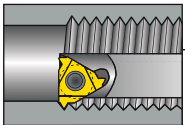

Klemmhalter für die Innenbearbeitung

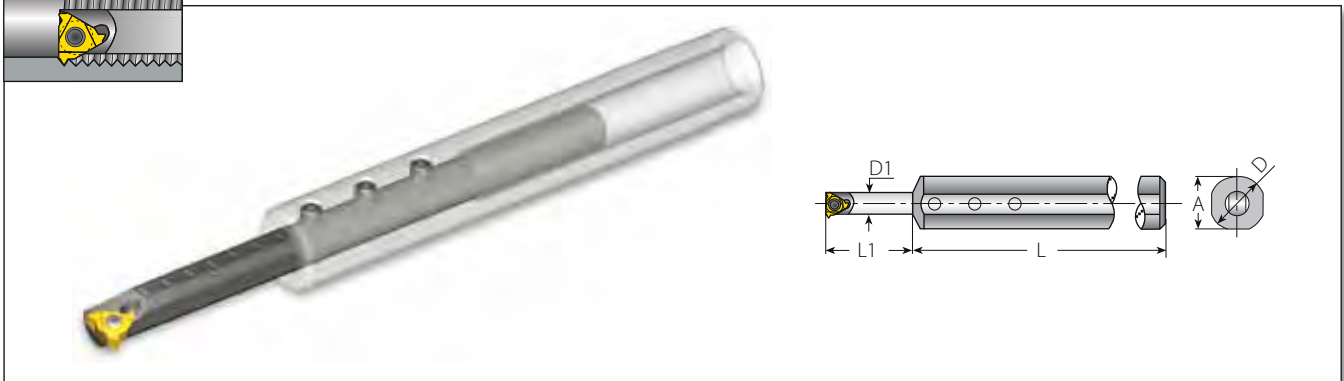

Mini-3 – Halter verstellbar

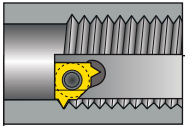

Plattengröße	Bestellnummer	Abmessungen mm				Ersatzteile					
IC	Hülse	Halter LH/RH	A	L	L1	D	D1	Klemmschraube	Torx-Schlüssel für Klemmschraube	Festschraube x3	Schlüssel für Festschraube
6.0	SV16-8.0	BNVR8.0T-6.0	15.6	100	8-56	16	8	SN6MT	K6MT	S4.0	K2.0

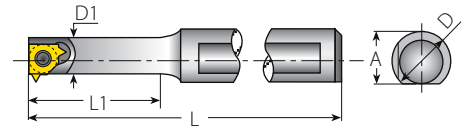

Klemmhalter für die Innenbearbeitung



Mini-L - Gewinde



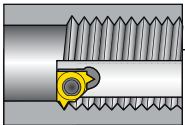

Plattengröße		Bestellnummer	Abmessungen mm				Dämpfungssystem	Ersatzteile	
IC	RH/LH	A	L	L1	D	D1			
5.0L	SNVR 10U-5L	9.4	81	16	10	6.2	ohne	SN5LT	K5LT
	BNVR 10S-5L	9.4	87	22	10	6.2	mit Hartmetallkern		
	BNVR 10M-5L	9.4	97	31	10	6.2	mit Hartmetallkern		
	BNVR 10L-5L	9.4	109	43	10	6.2	mit Hartmetallkern		

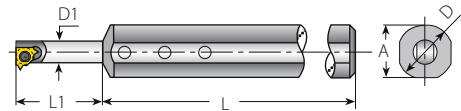

Klemmhalter für die Innenbearbeitung



Mini-L – Halter verstellbar

Plattengröße		Bestellnummer	Abmessungen mm					Ersatzteile			
IC	Hülse	Halter LH/RH	A	L	L1	D	D1				
5.0L	SV16-6.2	BNVR6.2T-5L	15.6	100	8-44	16	6.2	SN5LT	K5LT	S4.0	K2.0

Klemmhalter für die Innenbearbeitung



Gewindereihen
Klemmhalter



Micro - Zweiseitig



Micro-Gewinde Einsatzdurchmesser	Schaft durchmesser	Bestellnummer	Abmessungen mm			Justierschraube*			Befestigungsschraube x 3	
			d [mm]	D	L	L1	L0	Schraube	M	Schlüssel
3	10	SMC10-3.0	80	9- Kurz	89	4GISM8X28	28	K4.0	M4X0.7X4.0	K2.0
	12	SMC12-3.0		16- Mittel	96	4GISM8X21	21			
	16	SMC16-3.0	95	9- Kurz	104	4GISM8X49	49			
	20	SMC20-3.0		16- Mittel	111	4GISM8X42	42			
4	10	SMC10-4.0	80	9- Kurz	89	4GISM8X28	28			
	12	SMC12-4.0		16- Mittel	96	4GISM8X21	21			
	16	SMC16-4.0	95	21- Lang	101	4GISM8X16	16			
				9- Kurz	104	4GISM8X49	49			
6	12	SMC12-6.0	80	16- Mittel	96	4GISM8X21	21			
				21- Lang	101	4GISM8X16	16			
				9- Kurz	104	4GISM8X49	49			
	16	SMC16-6.0	95	16- Mittel	111	4GISM8X42	42			
21- Lang				116	4GISM8X37	37				

Jeder Klemmhalter Set enthält alle benötigten Justierschrauben

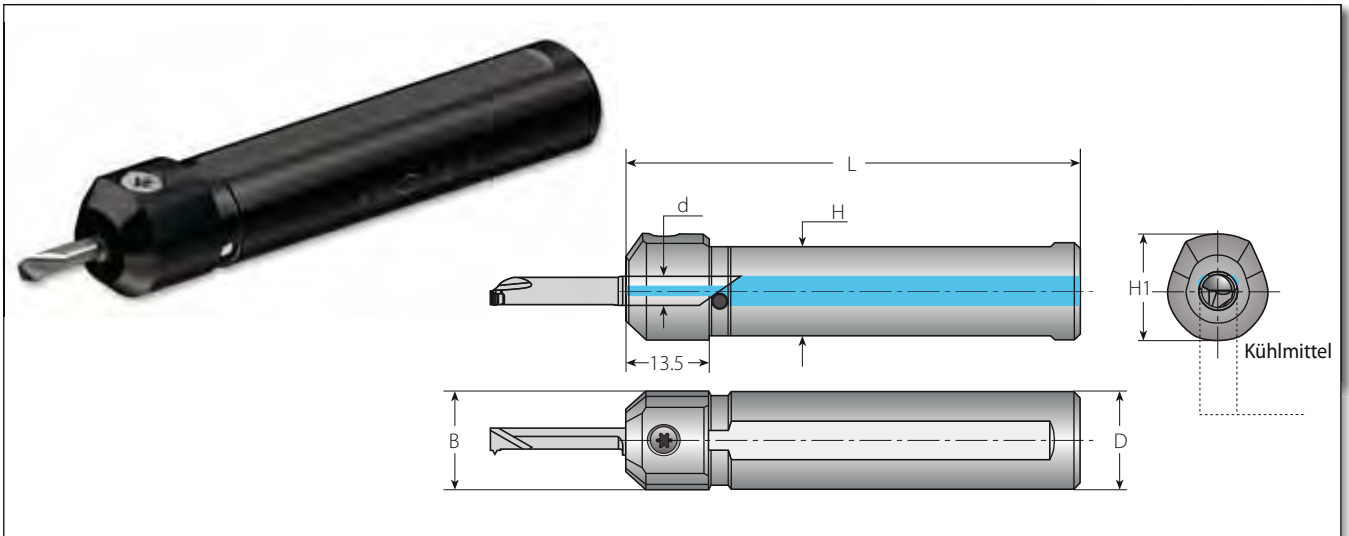

Klemmhalter für die Innenbearbeitung



Gewindedrehen
Klemmhalter

Micro - Einseitig

Ersatzteile **microscope**

Micro-Gewinde Einsatzdurchmesser	Bestellnummer	Abmessungen (mm)					
d [mm]		D=B	H1	H	L	Befestigungsschraube	Schlüssel
4.0	MHC 10-4	10	14	8.8	65	SL7DT15	KT15
	MHC 12-4	12	16	10.8	70		
	MHC 16-4	16	17.6	14.8	75		
	MHC 20-4	20	22	18.8	84		
5.0	MHC 10-5	10	14	8.8	65		
	MHC 12-5	12	16	10.8	70		
	MHC 16-5	16	18.6	14.8	75		
	MHC 20-5	20	22	18.8	84		
6.0	MHC 12-6	12	16	10.8	70		
	MHC 16-6	16	18.6	14.8	75		
	MHC 20-6	20	22	18.8	84		
7.0	MHC 16-7	16	18.6	14.8	75		
	MHC 20-7	20	22	18.8	84		

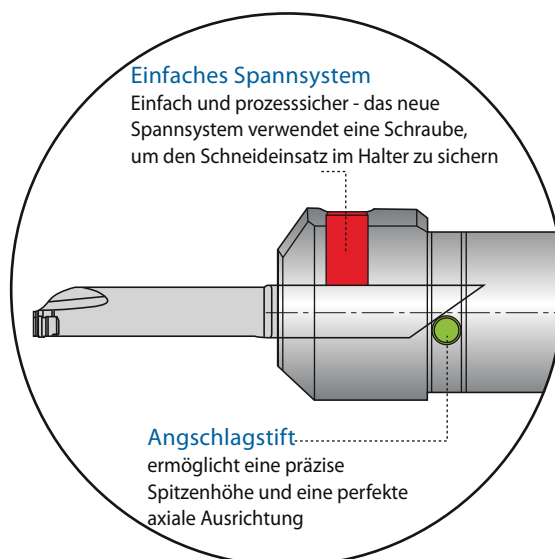

microscope Sets*



microscope Kit???

microscope Set 4

Bestellnummer	Inhalt			
	Halter			Torx Schlüssel 
KMS4-...	MHC16-4	M429TH F55 L16R...	Gewindedrehen	KT15
		M429TH F60 L16R...		
		M432BC R15 L16R...	Technische Daten	
		M422BC R10 L09R...		
		M442CL R15 L16R...	Kopieren	
		M442GS W100 L15R...	Einstecken	

microscope Set 5

Bestellnummer	Inhalt			
	Halter			Torx Schlüssel 
KMS5-...	MHC16-5	M542TH 0.75ISO L16R...	Gewindedrehen	KT15
		M549TH 1.00ISO L16R...		
		M552BC R20 L16R...	Technische Daten	
		M552BC R20 L26R...		
		M552CL R20 L25R...	Kopieren	
		M552GS W100 L15R...	Einstecken	

microscope Set 6

Bestellnummer	Inhalt			
	Halter			Torx Schlüssel 
KMS6-...	MHC16-6	M659TH A60 L16R...	Gewindedrehen	KT15
		M659TH A55 L16R...		
		M662BC R20 L21R...	Technische Daten	
		M662BC R20 L30R...		
		M662CL R20 L30R...	Kopieren	
		M662GS W100 L15R...	Einstecken	

Ersatzteile

Klemmhalter für Aussen - und Innenbearbeitung (ohne Micro und Microscope)

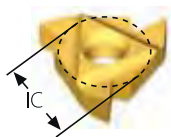

Plattengröße



Klemmschraube / Befestigungsschraube



Spannfinger



Schraube f. U-Platte & Scheibe



Schlüssel



Unterlegplatte



Klemmhalter	IC	Bestellnummer	Gewinde	Bestellnummer	Gewinde	EX RH / IN LH	IN RH / EX LH
Standard	1/4"	SN2T	M2.6x0.45x6.5	-	-	K2T	-
	3/8", 3/8"V6*	SA3T	UNC5x12.0	SY3T	UNC5x7.3	K3T	YE3/YE3-6C Y13/Y13-6C
	1/2"***	SA4T	UNC8x15.2	SY4T	UNC8x9.3	K4T	YE4 Y14
	5/8"	SA5T	M5x0.8x22.0	SY5T	M5x0.8x9.5	K5T	YE5 Y15
Standard mit Spannfinger	3/8"	SA3T/C3	UNC5x12.0/M5x0.8x22.0	SY3T	UNC5x7.3	K3CT	YE3 Y13
	1/2"	SA4T/C4	UNC8x15.2/M6x1.0x29.5	SY4T	UNC8x9.3	K4T	YE4 Y14
	5/8"	SA5T/C5	M5x0.8x22.0/M8x1.25x28.0	SY5T	M5x0.8x9.5	K5T	YE5 Y15
U Typ	1/2"U	SA4T	UNC8x15.2	SY4T	UNC8x9.3	K4T	YE4U Y14U
	5/8"U	SA5T	M5x0.8x22.0	SY5T	M5x0.8x9.5	K5T	YE5U Y15U
U Typ mit Spannfinger	1/2"	SA4T/C4	UNC8x15.2/M6x1.0x29.5	SY4T	UNC8x9.3	K4T	YE4U Y14U
	5/8"	SA5T/C5	M5x0.8x22.0/M8x1.25x28.0	SY5T	M5x0.8x9.5	K5T	YE5U Y15U
V Typ	1/4"V	SN2T	M2.6x0.45x6.5	-	-	K2T	-
	3/8"V	SN3TV	UNC5x7.5	-	-	K3T	-
	1/2"V	SN4T	UNC8x15.2	-	-	K4T	-
	5/8"V	SN6T	M6x1.0x29.5	-	-	K6T	-
Z+ Typ	1/2"Z	SA4T	UNC8x15.2	SY4T	UNC8x9.3	K4T	YE4Z Y14Z
	5/8"Z	SA5T	M5x0.8x22.0	SY5T	M5x0.8x9.5	K5T	YE5Z Y15Z
M+ Typ	3/8"M	SA3T	UNC5x12.0	SY3T	UNC5x7.3	K3T	YE3M Y13M
	1/2"M	SA4T	UNC8x15.2	SY4T	UNC8x9.3	K4T	YE4M Y14M
	5/8"M	SA5T	M5x0.8x22.0	SY5T	M5x0.8x9.5	K5T	YE5M Y15M
T+ Typ	1/2"T	SA4T	UNC8x15.2	SY4K2	UNC8x7.3	K4T/K2	Y4T Y4T
API	5/8"	SA5T/C5	M5x0.8x22.0/M8x1.25x28.0	SY5T	M5x0.8x9.5	K5T	YE5OIL Y15OIL
Mini-L - Gewinde	5.0L	SN5LT	M2x0.4x4.1	-	-	K5LT	-
Mini-3 - Gewinde	4.0mm	SN4MT	M2x0.4x4.0	-	-	K6MT	-
	6.0mm	SN6MT	M1.8x0.35x4.5	-	-	K6MT	-
Mini Thread verstellbare Klemmhalter	-	S4.0	M4x0.7x4.0	-	-	K2.0	-

* NVR16-3 erfordert Klemmschraube SN3T (UNC5x9.5) ** NVR20-4 erfordert Klemmschraube SN4T (UNC8x12.0) SN5T (M5x0.8x18) für Halter A/NVR32-5...

Für Micro und Microscope Werkzeughalter siehe Seiten 120-121.



Gewindedrehen

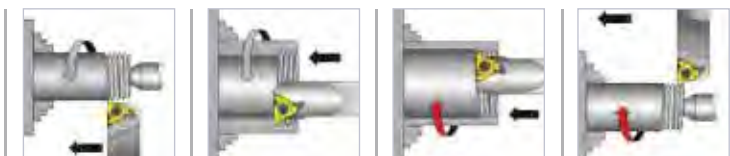

> Technische Daten

Technische Daten Gewindedrehen

■ Begriffe.....	Seite 127
■ Bearbeiten eines mehrgängigen Gewindes.....	Seite 128
■ Profilarten.....	Seite 128
■ Gewindedrehmethoden.....	Seite 129
■ Zustellungsmethoden - Gewindedrehen.....	Seite 129
■ Berechnung des Steigungswinkel und Wahl der richtigen Unterlegplatte.....	Seite 130
■ Unterlegplatten und Unterlegplatten- Sortimente.....	Seite 131
■ Sorten und ihre Anwendungen.....	Seite 132
■ Empfohlene Sorten und Schnittgeschwindigkeiten V_c (m/min.) - (ohne Mini und Micro).....	Seite 133
■ Empfohlene Sorten und Schnittgeschwindigkeiten V_c (m/min.) - (Mini und Micro).....	Seite 134
■ Anzahl der Durchgänge und Zustellung pro Durchgang.....	Seite 135
■ Schnittbedingungen abhängig von:.....	Seite 135
■ Anzahl der Durchgänge und Schnitttiefe pro Durchgang bei Multi+ platten.....	Seite 136
■ Gewindedrehen Schritt für Schritt – Beispiele.....	Seite 138
■ Werkstoffvergleichstabelle.....	Seite 142
■ Problemlösungen.....	Seite 146

Begriffe

Aussengewinde

Gewinde, das an der Aussenfläche eines Zylinders gebildet wird.

Aussengewinde

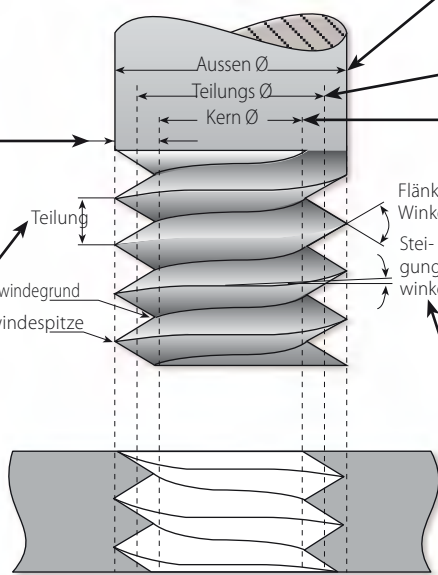

Aussendurchmesser

Durchmesser des imaginären Zylinders, der koaxial zum Gewinde liegt, und bei dem jede beliebige Mantellinie die Gewindespitzen des Aussengewindes bzw. den Gewindegrund des Innengewindes berührt.

Flankendurchmesser

Durchmesser des imaginären Zylinders, der koaxial zum Gewinde liegt, und bei dem jede beliebige Mantellinie das Gewindeprofil so schneidet, dass die durch Gewinderille und Gewindezahn gebildeten Abschnitte gleich sind.

Kerndurchmesser

Durchmesser des imaginären Zylinders, der koaxial zum Gewinde liegt, und bei dem jede beliebige Mantellinie den Gewindegrund des Aussengewindes bzw. die Gewindespitzen des Innengewindes berühren.

Steigungswinkel

Winkel, der gebildet wird durch die Tangente an die Schraubenlinie an einen am Flankendurchmesser des Gewindes liegenden Punkten und durch eine Ebene senkrecht zur Gewindeachse.

Gewindetiefe

Der achsensenkrechte Abstand zwischen Gewindespitze und Gewindegrund.

Teilung

Die Teilung bezeichnet den Abstand zweier unmittelbar benachbarter gleichgerichteter Gewindeflanken. Bei einer Schraube mit N-Gängen gilt für die Teilung $P=L/N$ (bei $N=1$ ist die Teilung=Steigung)

Nennendurchmesser

Der Durchmesser von welchem die Durchmessergrößen durch Anwendung der Abweichungszugaben und -toleranzen abgeleitet werden.

Gewinde, das auf der Innenfläche eines Zylinders oder Konus erzeugt wird.

Innengewinde

Zylindrisches Gewinde

Erzeugt auf einem Zylinder.

Konisches Gewinde

Erzeugt auf einem Kegel.

Linksgewinde

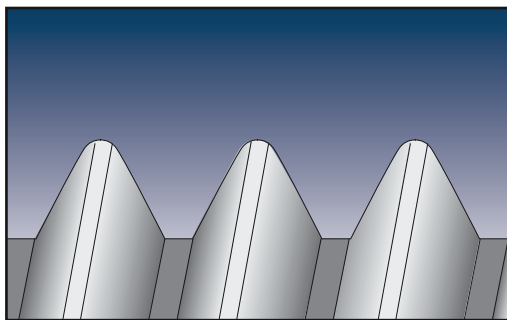

Gewinde, das sich, in Achsrichtung betrachtet, entgegen dem Uhrzeigersinn windet und in Achsrichtung verläuft (LH).

Rechtsgewinde

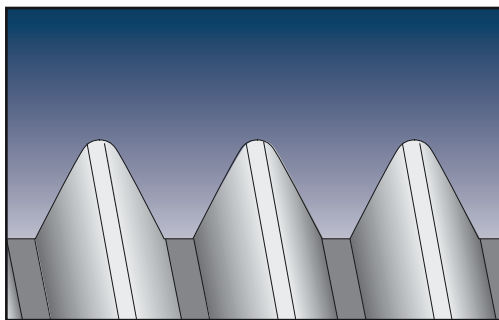

Gewinde, das sich, in Achsrichtung betrachtet, im Uhrzeigersinn windet und in Achsrichtung verläuft.

Der Steigungswinkel β

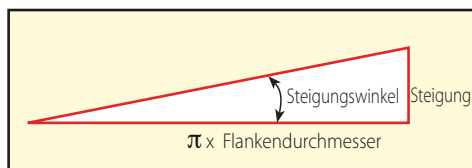

Steigung

Die Steigung bezeichnet den Weg, den ein Muttergewinde auf einem Bolzensgewinde bei einer 360°-Umdrehung in axialer Richtung zurücklegt. Steigung $L = \text{Teilung } P \times \text{Anzahl der Gänge } N$ (bei $N=1$ ist $P=L$)

Bearbeiten eines mehrgängigen Gewindes

Ein Gewinde dessen Steigung L einem ganzzahligen Mehrfachen der Teilung P entspricht.
 Ein mehrgängiges Gewinde erlaubt einen höheren Vorschub ohne eine grössere Gewindeform.

Erster bearbeiteter Durchgang

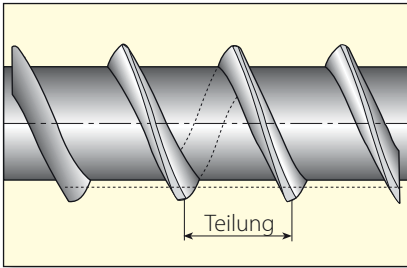

Zweiter bearbeiteter Durchgang

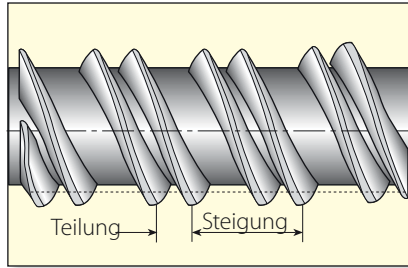

Dritter bearbeiteter Durchgang
(Ende, dreigängiges Gewinde)

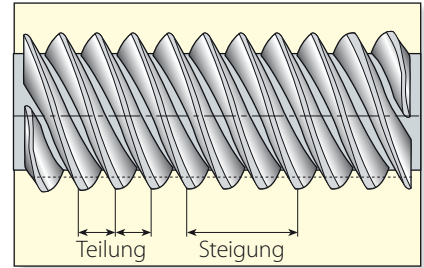

$Steigung = 3 \times Teilung$

Profilarten

Teilprofil

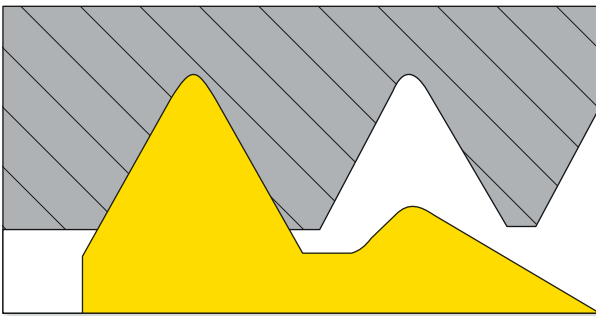

Die Teilprofilplatte schneidet den Aussendurchmesser (beim Aussengewinde) und den Innendurchmesser (beim Innengewinde) nicht mit. Die gleiche Platte kann für verschiedene Teilungen (innerhalb eines begrenzten Teilungsbereiches) eingesetzt werden.

Vollprofil

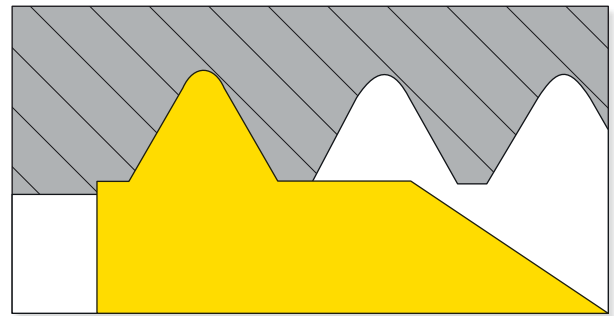

Die Vollprofilplatte schneidet das komplette Profil inklusive Spitze. Für jede GewindeTeilung und Norm ist eine andere Platte erforderlich.

Vollprofil für feine Teilungen

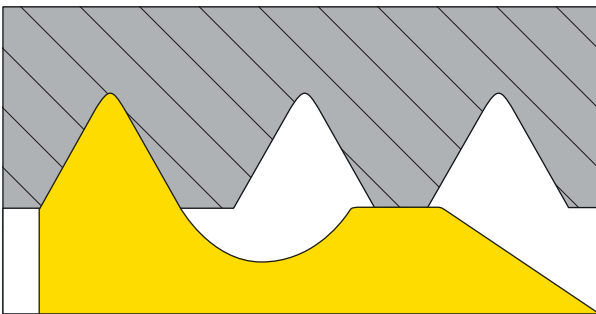

Die Spitze der Gewindeprofils wird durch den zweiten Zahn bearbeitet.

Semiprofil

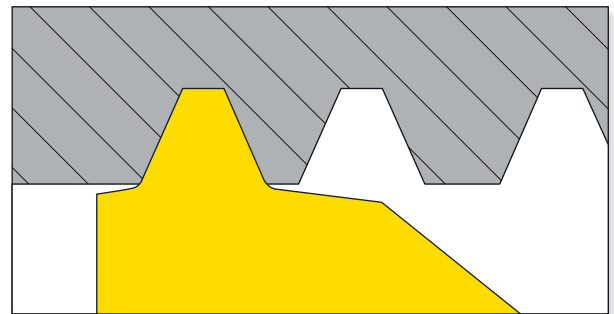

Die Semiprofilplatte schneidet das komplette Profil, entgratet die Spitze der Gewindeflanke, schneidet aber den Aussen / Innendurchmesser nicht mit. Wird hauptsächlich für Trapezgewinde verwendet.

Zustellungsmethoden - Gewindedrehen

Gewinde	WSP / Halter	Drehsinn	Vorschubrichtung	Gewindedrehen	Abb. Nr.
Aussen- Rechtsgewinde	EX RH	entgegen dem Uhrzeigersinn	In Richtung Futter	Regulär	1
	EX LH	Im Uhrzeigersinn	In Richtung Spitze	Umgekehrt	2
Innen- Rechtsgewinde	IN RH	entgegen dem Uhrzeigersinn	In Richtung Futter	Regulär	3
	IN LH	Im Uhrzeigersinn	In Richtung Spitze	Umgekehrt	4
Aussen- Linksgewinde	EX LH	Im Uhrzeigersinn	In Richtung Futter	Regulär	5
	EX RH	entgegen dem Uhrzeigersinn	In Richtung Spitze	Umgekehrt	6
Innen- Linksgewinde	IN LH	Im Uhrzeigersinn	In Richtung Futter	Regulär	7
	IN RH	entgegen dem Uhrzeigersinn	In Richtung Spitze	Umgekehrt	8

Aussen- Rechtsgewinde

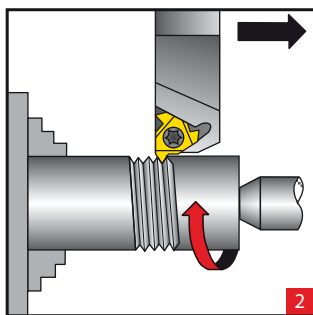
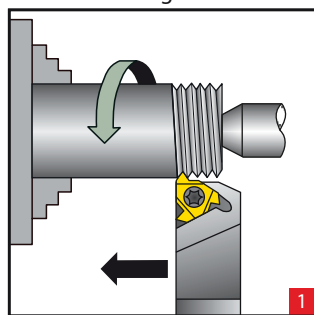

Aussen- Linksgewinde

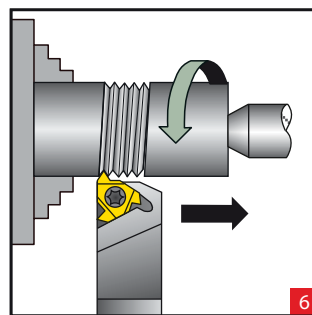
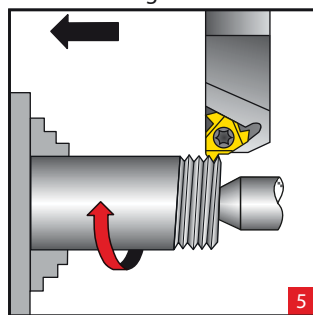

Innen- Rechtsgewinde

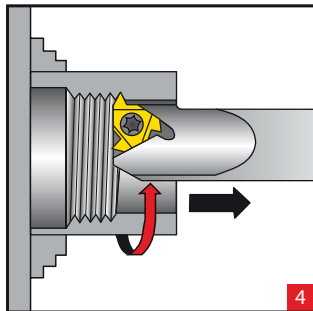
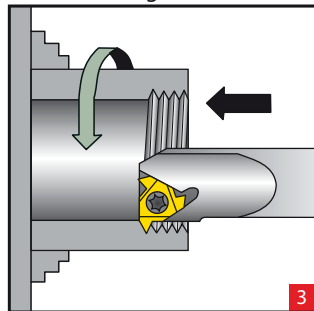

Innen- Linksgewinde

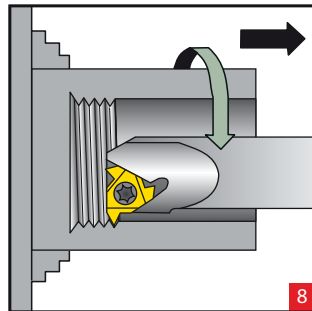
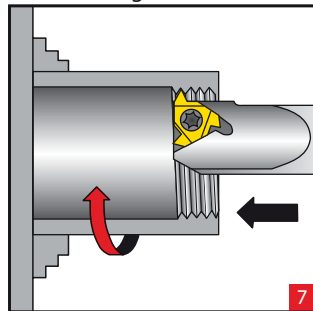

Durchgangsmethoden - Gewindedrehen

Radiale Zustellung

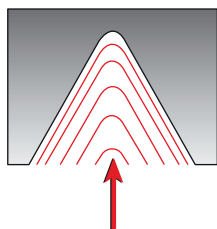

Radiale Zustellung ist die einfachste und schnellste Methode.

Zustellung erfolgt senkrecht zur Drehachse. Spanabhebende Bearbeitung durch beide Flanken der Platte.

Radiale Zustellung wird in drei Fällen empfohlen:

- bei Teilungen kleiner als 1 mm
- für kurzspanende Werkstoffe
- für die Bearbeitung gehärtete Werkstoffe

Zustellung entlang der Flanke

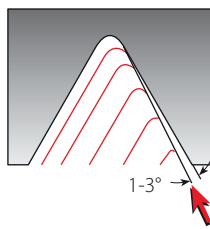

Zustellung entlang der Flanke wird in folgenden Fällen empfohlen:

- bei Steigungen grösser/gleich als 1 mm, da bei radialer Zustellung die effektive Schneidkantenlänge zu gross, was zum Rattern führen kann.
- bei TRAPEZ und ACME, wo das Spanen an drei Flanken für den Spanfluss von Nachteil ist.

Wechselseitige Zustellung

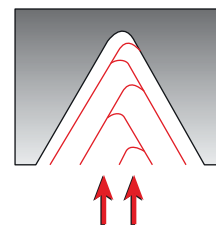

Die Anwendung der wechselseitigen Zustellungsmethode wird besonders bei grösseren Teilungen und bei langspanenden Werkstoffe empfohlen. Diese Methode verteilt die Bearbeitung gleichmässig auf beiden Flanken, was zu gleichmässigem Verschleiss der Schneidkanten führt. Die wechselseitige Zustellung erfordert einen komplizierteren Programmiervorgang und ist nicht auf allen Drehmaschinen möglich.

Berechnung des Steigungswinkels und Wahl der richtigen Unterlegplatte

Flankenfreiwinkel α (beispielhaft für Aussengewindedrehplatten)

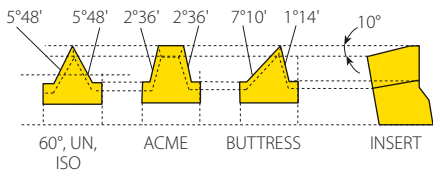

Vardex Klemmhalter wurden entwickelt um die Platte zu neigen, wenn Sie im Klemmhalter sitzt (10° für Aussen-Klemmhalter, 15° für Innen-Klemmhalter). Dies führt zu unterschiedlichen

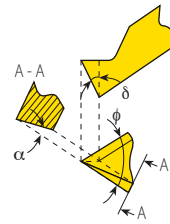

$$\alpha = \arctan(\tan(\frac{\phi}{2} \times \tan \delta))$$

Wo: α - Flankentriewinkel
 δ - Neigungswinkel
 ϕ - Flankenwinkel

Flankenfreiwinkeln, basierend auf der Geometrie der Schneidplatte. Um sicher zu stellen, dass die Seite der Schneidkante nicht auf dem Werkstück reibt, ist es sehr wichtig, dass der Steigungswinkel der Platte korrekt ist – speziell bei Profilen mit kleinen innenliegenden Flankenwinkeln. Diese Korrektur ist durch Vardex Unterlegplatten gegeben.

Berechnung des Steigungswinkel β

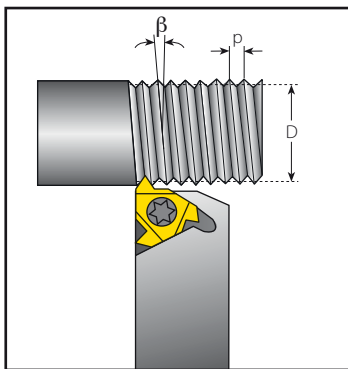

Der Steigungswinkel wird mit folgender Formel berechnet:

$$\beta = \arctan \frac{P \times N}{\pi \times D}$$

β - Steigungswinkel [°]
 P - Teilung [mm]
 N - Anzahl der Gänge
 D - Flankendurchmesser [mm]
 Steigung L = P x N

Der Steigungswinkel kann ebenfalls aus dem untenstehenden Diagramm abgelesen werden.

Steigungswinkeldiagramm

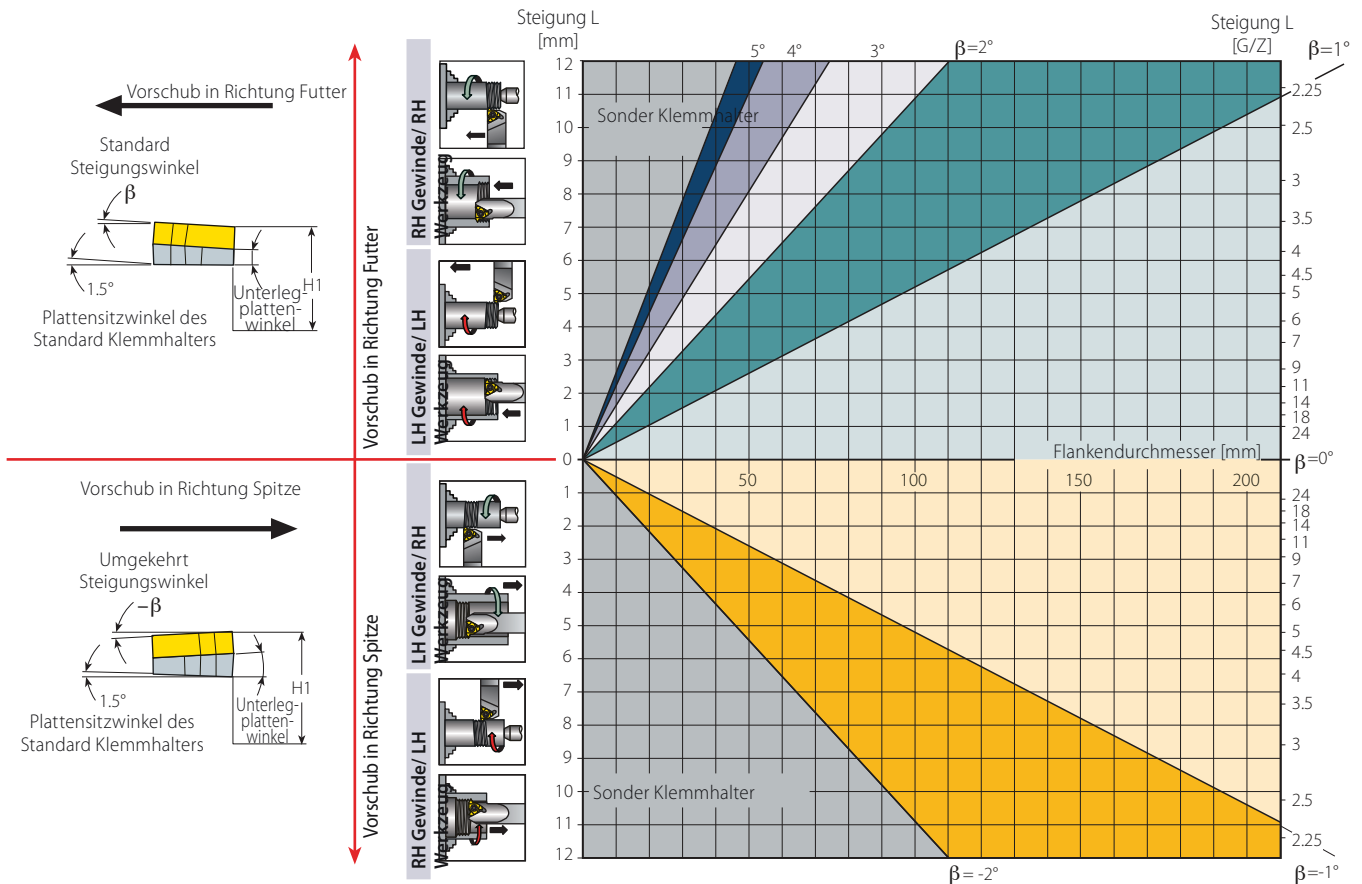

Unterlegplatten

Resultierender Steigungswinkel		4.5°	3.5°	2.5°	1.5°	0.5°	0°	-0.5°	-1.5°	
Plattengröße		Halter		Bestellnummer						
IC	L mm									
3/8"	16	ER/IL	YE3-3P	YE3-2P	YE3-1P	YE3	YE3-1N	YE3-1.5N	YE3-2N	YE3-3N
		EL/IR	YI3-3P	YI3-2P	YI3-1P	YI3	YI3-1N	YI3-1.5N	YI3-2N	YI3-3N
3/8" V6	16	ER	YE3-6C-3P	YE3-6C-2P	YE3-6C-1P	YE3-6C	YE3-6C-1N	YE3-6C-1.5N	YE3-6C-2N	YE3-6C-3N
		IR	YI3-6C-3P	YI3-6C-2P	YI3-6C-1P	YI3-6C	YI3-6C-1N	YI3-6C-1.5N	YI3-6C-2N	YI3-6C-3N
1/2"	22	ER/IL	YE4-3P	YE4-2P	YE4-1P	YE4	YE4-1N	YE4-1.5N	YE4-2N	YE4-3N
		EL/IR	YI4-3P	YI4-2P	YI4-1P	YI4	YI4-1N	YI4-1.5N	YI4-2N	YI4-3N
1/2"U	22	ER/IL	YE4U-3P	YE4U-2P	YE4U-1P	YE4U	YE4U-1N	YE4U-1.5N	YE4U-2N	YE4U-3N
		EL/IR	YI4U-3P	YI4U-2P	YI4U-1P	YI4U	YI4U-1N	YI4U-1.5N	YI4U-2N	YI4U-3N
5/8"	27	ER/IL	YE5-3P	YE5-2P	YE5-1P	YE5	YE5-1N	YE5-1.5N	YE5-2N	YE5-3N
		EL/IR	YI5-3P	YI5-2P	YI5-1P	YI5	YI5-1N	YI5-1.5N	YI5-2N	YI5-3N
5/8"U	27	ER/IL	YE5U-3P	YE5U-2P	YE5U-1P	YE5U	YE5U-1N	YE5U-1.5N	YE5U-2N	YE5U-3N
		EL/IR	YI5U-3P	YI5U-2P	YI5U-1P	YI5U	YI5U-1N	YI5U-1.5N	YI5U-2N	YI5U-3N
3/8"M	16	ER/IL			YE3M-1P	YE3M	YE3M-1N	YE3M-1.5N	YE3M-2N	
		EL/IR			YI3M-1P	YI3M	YI3M-1N	YI3M-1.5N		
1/2"M	22	ER/IL			YE4M-1P	YE4M	YE4M-1N	YE4M-1.5N	YE4M-2N	
		EL/IR			YI4M-1P	YI4M	YI4M-1N	YI4M-1.5N		
5/8"M	27	ER/IL				YE5M	YE5M-1N	YE5M-1.5N		
		EL/IR				YI5M	YI5M-1N	YI5M-1.5N		
1/2"Z	22	ER/IL			YE4Z-1P	YE4Z	YE4Z-1N			
		EL/IR			YI4Z-1P	YI4Z	YI4Z-1N			
5/8"Z	27	ER/IL				YE5Z				
		EL/IR				YI5Z				
1/2"T	22	ER / IL EL / IR					Y4T			

Standard Unterlegplatten		Unterlegplatte V6		U Typ Unterlegplatten		M Typ Unterlegplatten		Z Typ Unterlegplatten		T Typ Unterlegplatten	
ER/IL	EL/IR	ER	IR <small>V6 ist auf der Rückseite markiert</small>	ER/IL	EL/IR	ER/IL	EL/IR	ER/IL	EL/IR	ER/IL	EL/IR <small>Dieselbe unterlegplatte umgedreht</small>

Unterlegplatten- Sortimente

Unterlegplattengröße		Bestellnummer	Beigefügte Unterlegplatten:
IC	L mm		
3/8"	16	ABY3	YE3-2P, 1P, 1N, 2N, 3N
			YI3-2P, 1P, 1N, 2N, 3N
3/8" V6	16	ABY3-6C	YE3-6C-2P, 1P, 1N, 2N, 3N
			YI3-6C-2P, 1P, 1N, 2N, 3N
1/2"	22	ABY4	YE4-2P, 1P, 1N, 2N, 3N
			YI4-2P, 1P, 1N, 2N, 3N
1/2"U	22	ABY4U	YE4U-2P, 1P, 1N, 2N, 3N
			YI4U-2P, 1P, 1N, 2N, 3N
5/8"	27	ABYE5	YE5-2P, 1P, 1N, 2N, 3N
		ABYI5	YI5-2P, 1P, 1N, 2N, 3N
5/8"U	27	ABYE5U	YE5U-2P, 1P, 1N, 2N, 3N
		ABYI5U	YI5U-2P, 1P, 1N, 2N, 3N

Um sicherzustellen, dass jederzeit und für alle Bearbeitungsfälle die richtige Unterlegplatte zur Hand ist, empfehlen wir Ihnen diese Unterlegplatten- Sortimente.

Wichtig!

Verwenden Sie die V6 Unterlegplatte, wenn Sie die V6 Schneidplatte einsetzen.

Für rechte Außenplatte YE3-6C.

Für rechte Innenplatte YI3-6C.



Sorten und ihre Anwendungen

Allround		
VKX	VTX	VCB
 <p>Verschleißfeste Sorte für den universellen Einsatz. Sehr gut geeignet für Stahl und Edelstahl. Empfohlen für stabile Maschinenbedingungen. Geschliffene und gesinterte Spanleitstufen erhältlich. TiN-farbige PVD-Beschichtung</p>	 <p>Zähe, universelle Feinkornsorte. Bietet gute Bruchfestigkeit auch unter ungünstigen Bearbeitungsbedingungen. TiAlN-Beschichtung</p>	 <p>Gesinterte Spanleitstufe für langspanende Werkstoffe. TiAlN-Beschichtung</p>

Edelstahl	Nichteisen- Metallen, hitzebeständige Legierungen und Titan	
VM7	VK2	VK2P
 <p>Speziell ausgelegte Sorte für die Bearbeitung von rost- und säurebeständigen Stählen. PVD-Beschichtung</p>	 <p>Die unbeschichtete Sorte für Nichteisen-Metalle, Aluminium, hitzebeständige und Titanlegierungen.</p>	 <p>VK2 mit polierter Spanleitstufe zur Erzielung von verbesserten Oberflächen in Aluminium und zur Reduzierung der Aufbauschnittenbildung.</p>

MINIPRO

Micro & MicroScope	Mini "5L" & Mini IC 6.0	Mini IC 4.0
VMX	VHX	VTX
 <p>Universalsorte für 2-seitige Micro-Einsätze. TiN-farbige PVD-Beschichtung</p>	 <p>HSS-Sorte für Mini-L und Mini-3 6.0 Schneidplatten; für niedrige Schnittgeschwindigkeiten. TiN-farbige PVD-Beschichtung</p>	 <p>Hartmetallsorte für Mini-3 4.0. Für die Bearbeitung von rost- und säurebeständigen Stählen. TiAlN-Beschichtung</p>
VBX	VKP	VBX
 <p>Universelle Hartmetallsorte für MicroScope Schneideinsätze. TiCN-Beschichtung</p>	 <p>Universelle Hartmetallsorte für Mini-L und Mini-3 6.0 Schneidplatten. TiN-farbige PVD-Beschichtung</p>	 <p>Hartmetallsorte für Mini-3 4.0. Für die allgemeine Stahlbearbeitung. TiCN-Beschichtung</p>

Empfohlene Sorten und Schnittgeschwindigkeiten Vc [m/min] Ohne MiniPro

Materialgruppe	Vardex Nr.	Material	Brinell Härte HB	Vc [m/min]					
				Beschichtete				Unbeschichtet	
				VKX	VCB	VM7	VTX		VK2 / VK2P
P Stahl	1	Unlegierter Stahl	Geringer Kohlenstoffanteil (C=0.1-0.25%)	125	115-190	115-190		115-190	
	2		Mittlerer Kohlenstoffanteil (C= 0.25- 0.55%)	150	100-175	100-165		100-175	
	3		Hoher Kohlenstoffanteil (C= 0.55- 0.85%)	170	90-165	90-155		90-165	
	4	Niedriglegierter Stahl (Legierungs- Elemente ≤ 5%)	Ungehärtet	180	100-180	100-180		100-180	
	5		Gehärtet	275	75-140	75-140		75-140	
	6		Gehärtet	350	70-135	70-135		70-135	
	7	Hochlegierter Stahl (Legierungs-Elemente > 5%)	Vergütet	200	80-120	80-120		80-120	
	8		Gehärtet	325	50-100	50-100		50-100	
	9	Stahlguss	Niedriglegiert (Legierungs- Elemente ≤ 5%)	200	70-130	70-130		70-130	
	10		Hochlegiert (Legierungs- Elemente > 5%)	225	60-120	60-120		60-120	
M Edelstahl	11	Edelstahl Ferritisch	Ungehärtet	200	70-130	70-130	70-150	70-130	
	12		Gehärtet	330	60-115	50-95	60-125	60-115	
	13	Edelstahl Austenitisch	Austenitisch	180	90-140	80-120	90-160	90-140	
	14		Super- Austenitisch	200	40-110	30-100	40-120	40-110	
	15	Edelstahlguß Ferritisch	Ungehärtet	200	90-120	90-120	90-150	90-120	
	16		Gehärtet	330	65-110	65-110	65-120	65-110	
	17	Edelstahl- Guß Austenitisch	Austenitisch	200	85-110	85-110	85-120	85-110	
	18		Gehärtet	330	60-100	60-100	60-110	60-100	
K Gußeisen	28	Temperguss	Ferritisch (kurzspanig)	130	60-70	70-120		60-70	
	29		Perlitisch (langspanig)	230	60-145	70-120		60-145	
	30	Grauguss	Niedrigfest	180	70-130	70-130		70-130	
	31		Hochfest	260	60-115	60-100		60-115	
	32	Kugelgraphitguss	Ferritisch	160	125-160	125-160		125-160	
	33		Perlitisch	260	90-120	90-120		90-120	
N(K) Nichteisen- Metalle Metalle	34	Aluminium- Legierungen schmiedeeisern	ungealtert	60	100-365	100-250		100-365	100-250
	35		gealtert	100	80-220	80-180		80-220	80-160
	36	Aluminium- Legierungen	Guß	75	200-400	200-400		200-400	80-120
	37		Guß & gealtert	90	200-280	200-280		200-280	70-100
	38	Aluminium- Legierungen	Guß Si 13- 22%	130	60-180	60-150		60-180	50-120
	39	Kupfer und Kupferlegierungen	Messing	90	80-225	80-210		80-225	70-170
	40		Bronze und bleifreies Kupfer	100	80-255	80-210		80-255	70-170
S(M) Hitzebeständige Material	19	Hochtemperaturlegierungen	Vergütet (Eisen basiert)	200	45-60	45-60		45-60	30-50
	20		Gealtert (Eisen basiert)	280	30-50	30-50		30-50	25-40
	21		Vergütet (Nickel oder Cobalt basiert)	250	20-30	20-30		20-30	20-30
	22		Gealtert (Nickel oder Cobalt basiert)	350	15-25	15-25		15-25	15-25
	23	Titanlegierungen	Reines 99,5 Ti	400Rm	140-170	140-170		140-170	60-100
	24		α+ β Legierungen	1050Rm	50-70	50-70		50-70	40-60
H(K) Gehärtetes Material	25	Extra harter Stahl	Gehärtet & angelassen	45-50HRc	45-60	45-60		45-60	
	26			51-55HRc	40-50	40-50		40-50	

Gewindedrehen
Technische Daten

Berechnung von n [U/min.]

$$n = \frac{1000 \times V_c}{\pi \times D}$$

$$V_c = \frac{n \times \pi \times D}{1000}$$

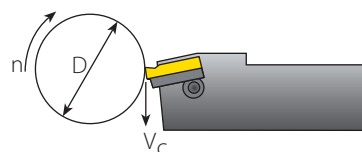

- n - n - Drehzahl [U/min]
- V_c - Schnittgeschwindigkeit [m/min.]
- D - Durchmesser des Werkstücks [mm]











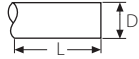





Empfohlene Sorten und Schnittgeschwindigkeiten Vc [m/min] Mini, Micro und Microscope

Materialgruppe	Vardex Nr.	Material	Brinell Härte HB	Vc [m/min]				
				Beschichtete				
				VMX (Micro)	VKP/VBX (Mini&Microscope)	VTX (Mini)	VHX (Mini)	
P Stahl	1	Unlegierter Stahl	Geringer Kohlenstoffanteil (C=0.1-0.25%)	125	50-120	140-200	150-200	20-50
	2		Mittlerer Kohlenstoffanteil (C= 0.25- 0.55%)	150	40-100	120-180	130-180	15-40
	3		Hoher Kohlenstoffanteil (C= 0.55- 0.85%)	170	30-80	110-180	120-180	15-30
	4	Niedriglegierter Stahl (Legierungs- Elemente ≤ 5%)	Ungehärtet	180	50-70	100-155	110-155	20-45
	5		Gehärtet	275	40-60	90-145	100-145	10-25
	6		Gehärtet	350	30-50	80-135	90-135	10-25
	7	Hochlegierter Stahl (Legierungs- Elemente > 5%)	Vergütet	200	30-50	65-115	70-115	
	8		Gehärtet	325	25-40	50-100	60-100	
	9	Stahlguss	Niedriglegiert (Legierungs- Elemente ≤ 5%)	200	30-50	30-50	30-50	25-40
	10		Hochlegiert (Legierungs- Elemente > 5%)	225	25-40	25-40	30-40	25-40
M Edelstahl	11	Edelstahl Ferritisch	Ungehärtet	200	60-100	80-120	90-120	
	12		Gehärtet	330	40-60	55-95	60-95	
	13	Edelstahl Austenitisch	Austenitisch	180	50-90	60-100	70-100	
	14		Super- Austenitisch	200	40-60	50-90	60-90	
	15	Edelstahlguß Ferritisch	Ungehärtet	200	40-60	60-80	70-80	
	16		Gehärtet	330	30-50	45-65	50-65	
	17	Edelstahl- Guß Austenitisch	Austenitisch	200	40-60	50-70	60-70	
	18		Gehärtet	330	30-50	40-60	40-60	
K Gußeisen	28	Temperguss	Ferritisch (kurzspanig)	130	50-70	60-80	70-80	
	29		Perlitisch (langspanig)	230	50-70	60-80	70-80	
	30	Grauguss	Niedrigfest	180	50-70	60-80	70-80	
	31		Hochfest	260	40-60	40-70	40-70	
	32	Kugelgraphitguss	Ferritisch	160	50-70	60-80	70-80	
	33		Perlitisch	260	60-80	70-90	80-90	
N(K) Nichteisen- Metalle Metalle	34	Aluminium- Legierungen schmiedeeisern	ungealtert	60	100-300	80-240	90-240	30-60
	35		gealtert	100	100-150	100-170	110-170	25-50
	36	Aluminium- Legierungen	Guß	75	100-150	100-150	110-150	25-50
	37		Guß & gealtert	90	60-100	60-100	70-100	20-40
	38	Aluminium- Legierungen	Guß Si 13- 22%	130	100-150	100-150	110-150	15-30
	39	Kupfer und Kupferlegierungen	Messing	90	60-100	80-200	90-200	15-35
40	Bronze und bleifreies Kupfer		100	60-100	80-200	90-200	15-35	
S(M) Hitzebestän- dige Material	19	Hochtemperaturlegie- rungen	Vergütet (Eisen basiert)	200	25-45	25-45	30-45	
	20		Gealtert (Eisen basiert)	280	20-30	20-30	20-30	
	21		Vergütet (Nickel oder Cobalt basiert)	250	15-20	15-20	15-20	
	22		Gealtert (Nickel oder Cobalt basiert)	350	10-15	10-15	15-20	
	23	Titanlegierungen	Reines 99,5 Ti	400Rm	60-100	60-100	70-100	
	24		α+β Legierungen	1050Rm	40-50	40-50	40-50	
H(K) Gehärtetes Material	25	Extra harter Stahl	Gehärtet & angelassen	45-50HRc	20-40	20-40	20-40	
	26			51-55HRc	20-40	20-40	20-40	

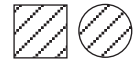
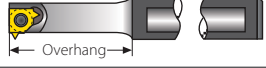
Anzahl der Durchgänge

Teilung	mm	0.50	0.75	1.00	1.25	1.50	1.75	2.00	2.50	3.00	3.50	4.00	4.50	5.00	5.50	6.00	8.00
	G/Z	48	32	24	20	16	14	12	10	8	7	6	5.5	5	4.5	4	3
Anzahl der Durchgänge		4-6	4-7	4-8	5-9	6-10	7-12	7-12	8-14	9-16	10-18	11-18	11-19	12-20	12-20	12-20	15-24
Anzahl der Durchgänge (SCB)		3-4	3-4	3-5	4-6	5-6	6-8	6-8	8-10	9-12	10-14						
Anzahl der Durchgänge (Micro / Scope & Mini)		6-9	6-11	6-12	8-14	9-15	11-18	11-18									

Schnittbedingungen abhängig von:

Werkstück	Werkstoff	
	Maße: Durchmesser und Länge	
	Spanbarkeit	
	Werkstoffhärte	
Gewinde	Außen oder innen	
	Norm	
	Oberflächengüte	
Maschine	Maschinenstabilität	
	Max. U/ Min.	
	Stabilität des Klemmsystems	
Kühlmittel	Kühlmittel	
Halter	Halterquerschnitt	
	Ausraglänge	
	Innenkühlung	
	Schaft: Hartmetall, Legierung, Hartmetallimplantat	
Platte	Sorte	
	Profilform: Teilung und Tiefe	
	Spitzenradius	
	Art des Spanbrechers	

Anzahl der Durchgänge und Schnitttiefe pro Durchgang bei Multi+ platten



Standard	Platte		Teilung	Zähne	Bestellnummer	Durchgänge	Schnitttiefe pro Durchgang					
	IC	L mm					RH					
ISO aussen	M+	3/8"	16	1.0 mm	3	3ER1.0ISO3M+...	2	0.32	0.30			
				1.5 mm	2	3ER1.5ISO2M+...	3	0.34	0.30	0.29		
				2.0 mm	2	3ER2.0ISO2M+...	3	0.45	0.40	0.38		
		1/2"	22	1.5 mm	3	4ER1.5ISO3M+...	2	0.48	0.45			
				2.0 mm	2	4ER2.0ISO2M+...	3	0.45	0.40	0.38		
				2.0 mm	3	4ER2.0ISO3M+...	2	0.64	0.59			
	T+	5/8"	27	2.5 mm	2	4ER2.5ISO2M+...	4	0.46	0.42	0.38	0.36	
				3.0 mm	2	5ER3.0ISO2M+...	4	0.53	0.47	0.45	0.39	
				1/2"	22	1.5 mm	8	4ER1.5ISO8T+...	1	0.93		
						2.0 mm	8	4ER2.0ISO8T+...	1	1.23		
ISO innen	M+	3/8"	16	1.0 mm	3	3IR1.0ISO3M+...	2	0.30	0.28			
				1.5 mm	2	3IR1.5ISO2M+...	3	0.31	0.28	0.27		
				2.0 mm	2	3IR2.0ISO2M+...	3	0.42	0.37	0.36		
		1/2"	22	1.5 mm	3	4IR1.5ISO3M+...	2	0.45	0.41			
				2.0 mm	2	4IR2.0ISO2M+...	3	0.42	0.37	0.36		
				2.0 mm	3	4IR2.0ISO3M+...	2	0.59	0.56			
	T+	5/8"	27	3.0 mm	2	5IR3.0ISO2M+...	4	0.49	0.45	0.42	0.37	
				1/2"	22	1.5 mm	8	4IR1.5ISO8T+...	1	0.86		
						2.0 mm	8	4IR2.0ISO8T+...	1	1.15		
				UN aussen	M+	3/8"	16	20 G/Z	3	3ER20UN3M+...	2	0.41
18 G/Z	2	3ER18UN2M+...	3					0.32	0.28	0.27		
18 G/Z	3	3ER18UN3M+...	2					0.45	0.42			
16 G/Z	2	3ER16UN2M+...	3					0.36	0.32	0.30		
14 G/Z	2	3ER14UN2M+...	3					0.43	0.38	0.37		
12 G/Z	2	3ER12UN2M+...	3					0.47	0.43	0.40		
1/2"	22	16 G/Z	3		4ER16UN3M+...	2	0.51	0.47				
		14 G/Z	2		4ER14UN2M+...	3	0.43	0.38	0.37			
		12 G/Z	2		4ER12UN2M+...	3	0.47	0.43	0.40			
		12 G/Z	3		4ER12UN3M+...	2	0.67	0.63				
5/8"	27	11 G/Z	2	4ER11UN2M+...	4	0.43	0.38	0.36	0.32			
		10 G/Z	2	4ER10UN2M+...	4	0.46	0.42	0.40	0.36			
UN innen	M+	3/8"	16	8 G/Z	2	5ER8UN2M+...	4	0.56	0.50	0.48	0.41	
				12 G/Z	2	3IR12UN2M+...	3	0.45	0.39	0.38		
				14 G/Z	2	3IR14UN2M+...	3	0.41	0.36	0.34		
		1/2"	22	16 G/Z	3	4IR16UN3M+...	2	0.47	0.44			
				14 G/Z	2	4IR14UN2M+...	3	0.41	0.36	0.34		
				12 G/Z	2	4IR12UN2M+...	3	0.45	0.39	0.38		
	5/8"	27	12 G/Z	3	4IR12UN3M+...	2	0.63	0.59				
	BSW aussen	M+	3/8"	16	8 G/Z	2	5IR8UN2M+...	4	0.52	0.47	0.44	0.38
					28 G/Z	2	3ER28W2M+...	3	0.23	0.20	0.20	
					19 G/Z	2	3ER19W2M+...	3	0.33	0.28	0.27	
19 G/Z					3	3ER19W3M+...	2	0.45	0.41			
1/2"			22	14 G/Z	2	3ER14W2M+...	3	0.43	0.38	0.35		
				14 G/Z	3	4ER14W3M+...	2	0.60	0.56			
11 G/Z	2	11 G/Z	2	4ER11W2M+...	4	0.44	0.38	0.36	0.30			

Gewindedrehen
Technische Daten

Anzahl der Durchgänge und Schnitttiefe pro Durchgang bei Multi+ platten



Standard	Platte	Plattengrösse		Teilung	Zähne	Bestellnummer	Durchgänge	Schnitttiefe pro Durchgang				
		IC	L mm					RH				
								1	2	3	4	
BSW innen	M+	3/8"	16	14	G/Z	2	3IR14W2M+...	3	0.43	0.38	0.35	
		1/2"	22	11	G/Z	2	4IR11W2M+...	4	0.44	0.38	0.36	0.30
NPT aussen	M+	3/8"	16	14	G/Z	2	3ER14NPT2M+...	3	0.52	0.45	0.43	
		1/2"	22	11.5	G/Z	2	4ER11.5NPT2M+...	4	0.46	0.43	0.42	0.40
		5/8"	27	11.5	G/Z	3	5ER11.5NPT3M+...	4	0.48	0.43	0.42	0.38
	8			G/Z	2	5ER8NPT2M+...	4	0.72	0.64	0.60	0.53	
	Z+	1/2"	22	11.5	G/Z	2	4ER11.5NPT2Z+...	4	0.46	0.43	0.42	0.40
				8	G/Z	2	4ER8NPT2Z+...	4	0.72	0.64	0.60	0.53
NPT innen	M+	3/8"	16	14	G/Z	2	3IR14NPT2M+...	3	0.52	0.45	0.43	
		1/2"	22	11.5	G/Z	2	4IR11.5NPT2M+...	4	0.46	0.43	0.42	0.40
		5/8"	27	11.5	G/Z	2	5IR11.5NPT3M+...	4	0.48	0.43	0.42	0.38
	8			G/Z	2	5IR8NPT2M+...	4	0.72	0.64	0.60	0.53	
	Z+	1/2"	22	11.5	G/Z	3	4IR11.5NPT2Z+...	4	0.46	0.43	0.42	0.40
				8	G/Z	2	4IR8NPT2Z+...	4	0.72	0.64	0.60	0.53
NPTF aussen	M+	3/8"	16	14	G/Z	2	3ER14NPTF2M+...	3	0.51	0.44	0.42	
NPTF innen	M+	3/8"	16	14	G/Z	2	3IR14NPTF2M+...	3	0.51	0.44	0.42	
APIBUT aussen	M+	5/8"	27	5	G/Z	2	5ER5BUT752M+...	4	0.46	0.41	0.39	0.33
	T+	1/2"	22	5	G/Z	3	4ER5BUT753T+...	3	0.57	0.52	0.50	
APIBUT innen	M+	5/8"	27	5	G/Z	2	5IR5BUT752M+...	4	0.46	0.41	0.39	0.33
	T+	1/2"	22	5	G/Z	3	4IR5BUT753T+...	3	0.57	0.52	0.50	
API RD aussen	M+	5/8"	27	10	G/Z	3	5ER10APIRD3M+...	2	0.74	0.69		
				8	G/Z	2	5ER8APIRD2M+...	3	0.66	0.60	0.58	
	T+	1/2"	22	10	G/Z	6	4ER10APIRD6T+...	2	0.71	0.71		
				8	G/Z	3	4ER8APIRD3T+...	2	0.94	0.90		
				8	G/Z	5	4ER8APIRD5T+...	2	0.94	0.90		
	API RD innen	M+	1/2"	22	10	G/Z	2	4IR10APIRD2M+...	3	0.52	0.46	0.45
8					G/Z	2	4IR8APIRD2M+...	3	0.66	0.60	0.58	
5/8"					27	10	G/Z	3	5IR10APIRD3M+...	3	0.48	0.48
		8	G/Z	2		5IR8APIRD2M+...	3	0.66	0.60	0.58		
Z+		1/2"	22	8	G/Z	2	4IR8APIRD2Z+...	3	0.66	0.60	0.58	
				10	G/Z	6	4IR10APIRD6T+...	2	0.71	0.71		
T+	1/2"	22	8	G/Z	3	4IR8APIRD3T+...	2	0.94	0.90			
			8	G/Z	5	4IR8APIRD5T+...	2	0.94	0.90			

Gewindedrehen
Technische Daten



M+ Typ Platte



T+ Typ Platte



Z+ Typ Platte

Gewindedrehen Schritt für Schritt – Beispiel 1

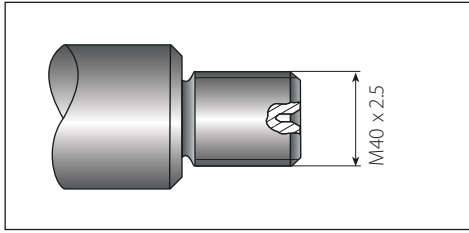

Anwendung:
 Gewinde: Aussen RH ISO metrisch M40x2.5
 Werkstoff: 42CrMo4 (25 HRC)

U Auswahl der Gewindedrehmethode

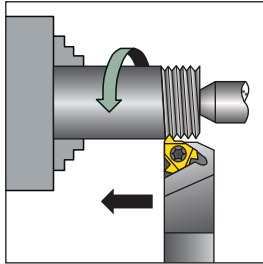

Vorschub in Richtung Futter wurde gewählt. Es werden eine Aussen- Rechtsplatte und ein Aussen- Rechtshalter verwendet.

V Wahl der Plattengröße

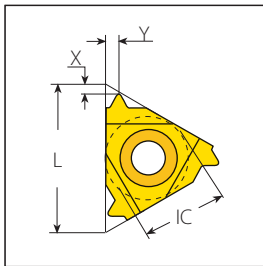

Gewählte Schneidplatte: 3ER2.5ISO

Plattengröße	Teilung	Bestellnummer	Unterlegplatte	Klemmhalter
IC	L mm	mm	RH	RH
3/8"	16	2.5	3ER2.5ISO ...	YE3 AL...-3 (LH)

W Wahl des Klemmhalters

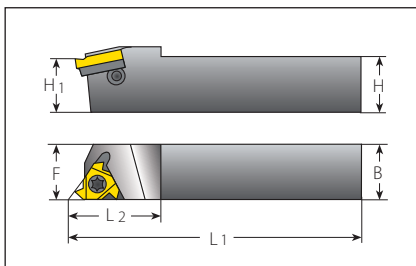

Gewählter Klemmhalter: AL 25-3

Plattengröße	Bestellnummer	Abmessungen mm			
IC	RH	H=H1=B	F	L1	L2
3/8"	AL 25-3	25	25	153.6	30

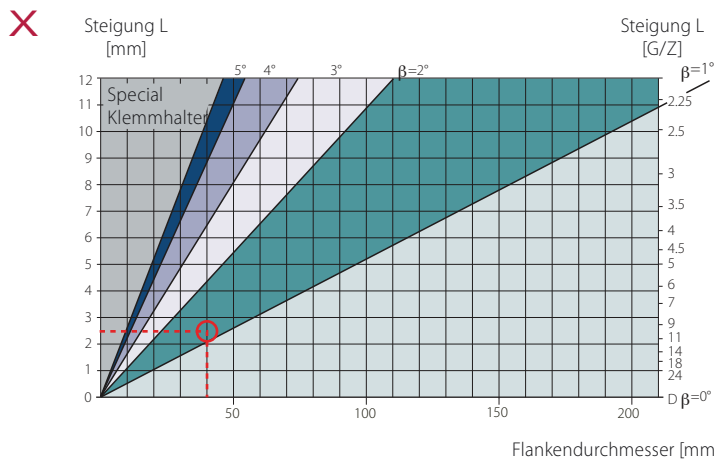

Bei einer Steigung von 2.5 mm (10 G/ Z) und einem Werkstückdurchmesser von 40 mm (1.57") können wir aus der Tabelle einen Steigungswinkel von 1.5° ablesen.

Y Wahl der richtigen Unterlegplatte

Gewählte Unterlegplatte: **YE3** Resultierender Steigungswinkel 3.5 2.5 **1.5** 0.5

Plattengröße	Bestellnummer	Halter	Bestellnummer	
IC	L mm		YE3-2P	YE3-1P
3/8"	16	ER/IL		YE3

U Wahl der Hartmetallsorte und Schnittgeschwindigkeit

Gewählte Hartmetallsorte:
VTX
Schnittgeschwindigkeit:
140 m/min

Werkstoff:	Härte Brinell HB	VTX	VCB
P Niedriglegierter Stahl (Legierungselemente ≤ 5%)	Ungehärtet	180	100-180
	Gehärtet	275	75-140
	Gehärtet	350	70-135

V Bestimmung der Anzahl der Durchgänge

Anzahl der Durchgänge: 10

ISO aussen

Teilung	mm	1.50	1.75	2.00	2.50	3.00	3.50	4.00
G/Z		16	14	12	10	8	7	6
Anzahl der Durchgänge		6-10	7-12	7-12	8-14	9-16	10-18	11-18

Zusammenfassung

Gewinde	ISO M40x2.5 aussen, RH
U Vorschubrichtung:	in Richtung Futter
V Schneidplatte und Sorte:	3ER2.5ISO VTX
W Klemmhalter:	AL 25 - 3
X Steigungswinkel:	1.5°
Y Unterlegplatte:	YE3
U Schnittgeschwindigkeit:	140 m/min
V Anzahl der Durchgänge:	14

Gewindedrehen Schritt für Schritt – Beispiel 2

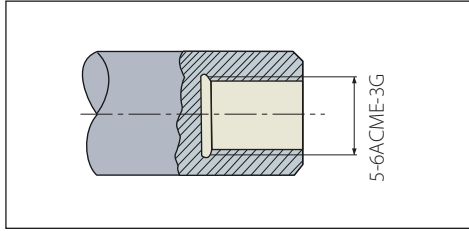

Anwendung:
 Gewinde: Innen, RH ACME
 Teilung: 6 G/Z
 Bohrungsdurchmesser: 5"
 Werkstoff: Edelstahl austenitisch

U Auswahl der Gewindedrehmethode

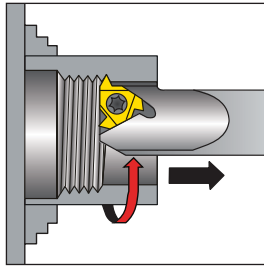

Um das Entfernen der Späne von aus Bohrung zu vereinfachen, wählen wir eine Vorschubrichtung vom Futter weg. Daher sind eine Innen- Linksplatte und ein Innen- Linksklemmhalter zu verwenden.

V Wahl der Plattengröße

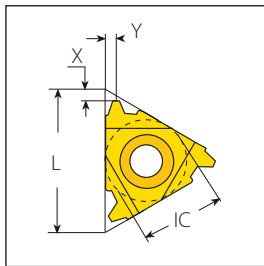

Gewählte Schneidplatte: **4IL6ACME**

Plattengröße		Teilung	Bestellnummer	Unterlegplatte	Klemmhalter
IC	L mm	G/Z	RH	LH	
1/2"	22	6	4IL6ACME...	YE4	AVR..-4 (LH)

W Wahl des Klemmhalters

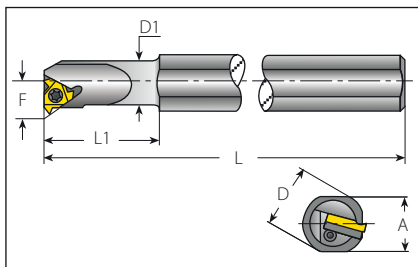

Gewählter Klemmhalter: **AVR 40-4LH**

Plattengröße	Bestellnummer	Abmessungen mm			Steigung	Min Ø		
IC	RH	A	L	L1	D	F	mm	
1/2"	AVR 40-4	36.0	300	60	40	40.0	25.8	47

X Bestimmung des Steigungswinkels

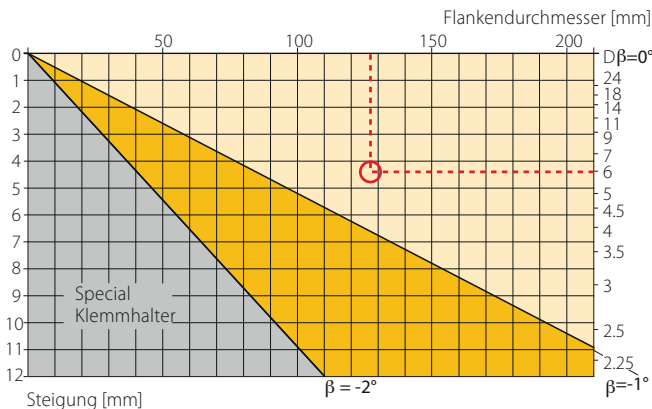

In diesem Fall wird ein Rechtsgewinde mit einem LH Klemmhalter gedreht. Die umgekehrte Teilungswinkelmethode wird angewandt. Unter Verwendung einer Steigung von 6 G/ Zoll und einem Bohrungsdurchmesser von 127 mm erhalten wir vom unteren Teil des Diagramms einen Steigungswinkel von **- 0.65°**

y Wahl der richtigen Unterlegplatte

Gewählte Unterlegplatte: YE4-2N

Resultierender Steigungswinkel	1.5	0.5	0	-0.5	-1.5		
Plattengröße		Bestellnummer					
IC	L mm	ER/IL	YE4	YE4-1N	YE4-1.5N	YE4-2N	YE4-3N
1/2"	22						

U Wahl der Hartmetallsorte und Schnittgeschwindigkeit

Gewählte Hartmetallsorte: VTX
Schnittgeschwindigkeit: 140 m/min

	Werkstoff:	Härte Brinell HB	VTX	VCB
M	Edelstahl Austenitisch	Austenitisch	180	80-120
		Super-Austenitisch	200	30-100

V Bestimmung der Anzahl der Durchgänge

Anzahl der Durchgänge: 18

ACME aussen & innen

Teilung	mm	3.00	3.50	4.00	4.50	5.00	5.50	6.00
	G/Z	8	7	6	5.5	5	4.5	4
Anzahl der Durchgänge		9-16	10-18	11-18	11-19	12-20	12-20	12-20

Zusammenfassung

Gewinde	5" x6 ACME innen, rechts
U Vorschubrichtung:	Vom Futter weg, Richtung Reitstock
V Schneidplatte und Sorte:	4IL6ACME VTX
W Klemmhalter:	AVR 40-4LH
X Steigungswinkel:	-0.65°
y Unterlegplatte:	YE4-2N
U Schnittgeschwindigkeit:	140 m/min
V Anzahl der Durchgänge:	18

Werkstoffvergleichstabelle

Materialgruppe	Vardex Nr.	USA AISI/SAE	Deutschland W.-Nr.	Deutschland DIN	Großbritannien BS	Frankreich AFNOR	Italien UNI
P Stahl	1	1015	1.0037	St37-2	Fe360B	E24-2	Fe360 B FU
	1	1020	1.0044	St44-2	Fe430B FN	E28-2	Fe430B FN
	2	ASTM A570Gr.50	1.0050	St50-2	Fe490-2 FN	A50-2	Fe490
	2	-	1.0070	St70-2	Fe690-2 FN	A70-2	Fe690
	1	1015	1.0401	C15	080M15	CC12	C15C16
	1	1020	1.0402	C22	050A20	CC20	C20C21
	2	1035	1.0501	C35	060A35	CC35	C35
	2	1045	1.0503	C45	080M46	CC45	C45
	2	1055	1.0535	C55	070M55	-	C55
	2	1060	1.0601	C60	080A62	CC55	C60
	1	1213	1.0715	9SMn28	230M07	S250	CF95Mn28
	1	12L13	1.0718	9SMnPb28	-	S250Pb	CF95MnPb28
	1	-	1.0722	10SPb20	-	10PbF2	CF10SPb20
	2	1140	1.0726	35S20	212M36	35MF4	-
	2	1215	1.0736	9SMn36	240M07	S300	CF95Mn36
	2	12L14	1.0737	9SMnPb36	-	S300Pb	CF95MnPb36
	2	9255	1.0904	55Si7	250A53	55S7	55Si8
	2	9262	1.0961	60SiCr7	-	60SC7	60SiCr8
	1	1015	1.1141	Ck15	080M15	XC1 2	C16
	2	1039	1.1157	40Mn4	150M36	35M5	-
	2	1025	1.1158	Ck25	-	-	-
	2	1335	1.1167	36Mn5	-	40M5	-
	2	1330	1.1170	28Mn6	150M28	20M5	C28Mn
	2	1035	1.1183	Cf35	060A35	XC38TS	C36
	2	1045	1.1191	Ck45	080M46	XC42	C45
	2	1055	1.1203	Ck55	070M55	XC55	C50
	3	1050	1.1213	Cf53	060A52	XC48TS	C53
	3	1060	1.1221	Ck60	080A62	XC60	C60
	8	1095	1.1274	Ck101	060A96	-	-
	9	-	1.3401	X120Mn12	Z120M12	Z120M12	XG120Mn12
	8	52100	1.3505	100Cr6	534A99	100C6	100Cr6
	8	ASTM A20Gr.A	1.5415	15Mo3	1501-240	15D3	16Mo3KW
	8	4520	1.5423	16Mo5	1503-245-420	-	16Mo5
	4	ASTMA350LF5	1.5622	14Ni6	-	16N6	14Ni6
	8	ASTM A353	1.5662	X8Ni9	1501-509; 510	-	X10Ni9
	8	2515	1.5680	12Ni19	-	Z18N5	-
	5	3135	1.5710	36NiCr6	640A35	35NC6	-
	5	3415	1.5732	14NiCr10	-	14NC11	16NiCr11
	5	3415; 3310	1.5752	14NiCr14	655M13; 655M12	12NC15	-
	5	9840	1.6511	36CrNiMo4	816M40	40NCD3	38NiCrMo4(KB)
	5	8620	1.6523	21NiCrMo2	805M20	20NCD2	20NiCrMo2
	5	8740	1.6546	40NiCrMo22	311-Type7	-	40NiCrMo2(KB)
	5	4340	1.6582	34CrNiMo6	817M40	35NCD6	35NiCrMo6(KB)
	5	-	1.6587	17CrNiMo6	820A16	18NCD6	-
	5	-	1.6657	14NiCrMo134	832M13	-	15NiCrMo13
	2	5015	1.7015	15Cr3	523M15	12C3	-
	5	5132	1.7033	34Cr4	530A32	32C4	34Cr4(KB)
	5	5140	1.7035	41Cr4	530M40	42C4	41Cr4
	5	5140	1.7045	42Cr4	-	-	-
	5	5115	1.7131	16MnCr5	(527M20)	16MC5	16MnCr5
5	5155	1.7176	55Cr3	527A60	55C3	-	
5	4130	1.7218	25CrMo4	1717CDS110	25CD4	25CrMo4(KB)	
5	4137; 4135	1.7220	34CrMo4	708A37	35CD4	35CrMo4	
5	4140; 4142	1.7223	41CrMo4	708M40	42CD4TS	41CrMo4	
5	4140	1.7225	42CrMo4	708M40	42CD4	42CrMo4	
5	-	1.7262	15CrMo5	-	12CD4	-	
5	ASTM A182; F11; F12	1.7335	13CrMo4 4	1501-620Gr.27	15CD3.5; 15CD4.5	14CrMo4 5	
5	-	1.7361	32CrMo12	722M24	30CD12	32CrMo12	
5	ASTM A182; F22	1.7380	10CrMo9 10	1501-622; Gr.31; 45	12CD9; 10	12CrMo9, 10	
5	-	1.7715	14MoV6 3	1503-660-440	-	-	
5	6150	1.8159	50CrV4	735A50	50CV4	50CrV4	
8	-	1.8509	41CrAlMo7	905M39	40CAD6, 12	41CrAlMo7	
8	-	1.8523	39CrMoV13 9	897M39	-	36CrMoV12	
5	W.110	1.1545	C105W1	-	Y1105	C98KU; C100KU	
5	W.112	1.1663	C125W	-	Y2120	C120KU	
8	L3	1.2067	100Cr6	BL3	Y100C6	-	
10	D3	1.2080	X210Cr12	BD3	Z200Cr12	X210Cr13KU	
10	-	-	-	-	-	X250Cr12KU	
10	-	1.2311	40CrMnMo7	-	-	35CrMo8KU	
10	-	1.2312	40CrMnMoS8-6	-	-	-	
10	H11	1.2343	X38CrMoV5-1	BH11	Z38CDV5	X37CrMoV51 1KU	
10	H13	1.2344	X40CrMoV5-1	BH13	Z40CDV5	X35CrMoV05KU	
10	-	-	-	-	-	X40CrMoV511KU	
10	A2	1.2363	X100CrMoV5-1	BA2	Z1 00CDV5	X100CrMoV51KU	
10	-	1.2367	X38CrMoV5-3	-	Z38CDV5-3	-	
10	D2	1.2379	X155CrVMo 12-1	BD2	Z160CDV12	X155CrVMo12 1 KU	
10	-	1.2419	105WCr6	-	105WC13	10WCr6; 107WCr5KU	
10	-	1.2436	X210CrW12	-	-	X215CrW121KU	
10	S1	1.2542	45WCrV17	B51	-	45WCrV8KU	
10	H21	1.2581	X30WCrV9 3	BH21	Z30WCV9	X30WCrV9 3KU	
10	-	1.2601	X165CrMoV12	-	-	X165CrMoV12KU	
10	L6	1.2713	55NiCrMoV6	-	55NCDV7	-	
10	-	1.2738	40CrMnNiMo8-6-4	-	-	-	
10	W210	1.2833	100V1	BW2	Y1105V; 100V2	-	
10	-	1.3243	S 6-5-2-5	-	Z85WDCV-06-05-05-04-02	HS 6-5-2-5	
10	T4	1.3255	S 18-1-2-5	BT4	Z80WKCV-18-05-04-01	X78WCo1805KU	
10	M2	1.3343	S 6-5-2	BM2	Z85WDCV-06-05-04-02	X82WCo0605KU	
10	M7	1.3348	S 2-9-2	-	Z100WDCV-09-04-02-02	HS 2-9-2	
10	T1	1.3355	S 18-0-1	BT1	Z80WCV-18-04-01	X75W18KU	

Gewindedrehen
Technische Daten

P

Schweden SS	Japan JIS	Russland GOST	Spanien UNE	Vardex Nr.
1311	STKM 12A;C	–	Fe360B	1
1412	SM400A;B;C	St4ps;sp	Fe430B FN	1
1550	SS490	St5ps;sp	A490-2	2
–	–	–	A690-2	2
1350	–	–	F0.111	1
1450	–	20	1 C 22 ; F.112	1
1550	–	30	F.113	2
1650	–	45	F0.114	2
1655	–	55	F0.115	2
–	–	60(G)	–	2
1912	SUM22	–	F.2111-11SMn28	1
1914	SUM22L	–	F.2112-11SMnPb28	1
–	–	–	F.2122-10SPb20	1
1957	–	–	F.210.G	2
–	–	–	F.2113-12SMn35	2
1926	–	–	F.2114-12SMnPb35	2
2085	–	55S2	F.1440-56Si7	2
–	–	–	F.1442-60SiCr8	2
1370	S15C	15	F.1110-C15k ; F.1511-C16k	1
–	–	40G	–	2
–	S25C	25	F.1120-C25k	2
2120	SMn438(H)	35G2 ; 35GL	F.1203-36Mn6 ; F.8212-36Mn5	2
–	SCM1	30G	28Mn6	2
1572	S35C	35	–	2
1672	S45C	45	F.1140-C45k ; F.1142-C48k	2
–	S55C	55	F.1150-C55k	2
1674	S50C	50	–	3
1678	S58C	60 ; 60G ; 60GA	–	3
1870	SUP4	–	–	8
–	SCMnH/1	110G13L	F.8251-AM-X120Mn12	9
2258	SUJ2	SchCh15	F.1310-100Cr6	8
2912	–	–	F.2601-16Mo3	8
–	–	–	F.2602-16Mo5	8
–	–	–	F.2641-15Ni6	4
–	–	–	F.2645-X8Ni09	8
–	–	–	–	8
–	SNC236	–	–	5
–	SNC415(H)	–	F.1540-15NiCr11	5
–	SNC81 5(H)	–	–	5
–	–	40ChN2MA ; 40ChGNM	F.1280-35NiCrMo4	5
2506	SNM220(H)	20ChGNM	F.1552-20NiCrMo2 ; F.1534-20NiMo31	5
–	SNM240	38ChGNM	F.1204-40NiCrMo2 ; F.1205-40NiCrMo2DF	5
2541	–	38Ch2N2MA	F.1272-40NiCrMo7 ; 34CrNiMo6	5
–	–	–	F.1560-14NiCrMo13	5
–	–	–	F.1560-14NiCrMo13 ; F.1569-14NiCrMo131	5
–	SCR415(H)	15Ch	–	2
–	SCR430(H)	35Ch	F.8221-35Cr4	5
–	SCR440(H)	40Ch	F.1211-41Cr4DF ; F.1202-42Cr4	5
2245	SCR440	40Ch	F.1202-42Cr4	5
2511	–	18ChG	F.1516-16MnCr5 ; F.1517-16MnCr5	5
–	SUP9(A)	50ChGA	F.1431-55Cr3	5
2225	SCM420	20ChM ; 30ChM	F.8372-AM26CrMo4;F.8330-AM25CrMo4;F.1256-30CrMo4-1	5
2234	SCM432; SCCRM3	AS38ChGM;35ChM;35ChML	F.8331-AM34CrMo4;F.823134CrMo4;F.1250-35CrMo4;F.1254-35CrMo4DF	5
2244	SCM440	40ChFA	F.8332-AM42CrMo4;F.8232-42CrMo4;F.1252-40CrMo4	5
2244	SCM440(H)	–	F.8332-AM42CrMo4;F.8232-42CrMo4;F.1252-40CrMo4	5
2216	SCM415(H)	–	F.1551-12CrMo4	5
–	–	12ChM ; 15ChM	F.2631-14CrMo45	5
2240	–	–	F.124.A	5
2218	–	12Ch8	TU.H	5
–	–	–	F.2621-13MoCrV6	5
2230	SUP10	50ChGFA ; 50ChFA	F.1430-51CrV4	5
2940	–	38ChMJuA	F.1740-41CrAlMo7	8
–	–	–	–	8
1880	–	U10A-1;2	F0.516	5
–	SK2	U13	F.5123 ; C120	5
–	–	Ch	F.5230 ; 100Cr6	8
–	SKD1	Ch12	F.5212 ; X210 Cr12	10
–	–	–	–	10
–	–	–	–	10
–	–	–	–	10
–	SKD6	4ChMFS	F.5317 ; X37 CrMoV5	10
2242	SKD61	4ChMF1S	F.5318 ; X40CrMoC5	10
–	–	–	–	10
2260	SKD12	–	F.5227 ; X100CrMoV5	10
–	–	–	–	10
2310	SKD11	–	F.520A	10
2140	SKS31;SKS2,SKS3	ChWG	F.5233 ; 105WCr5	10
2312	SKD2	–	F.5213 ; X210CrW12	10
2710	–	5ChW2SF	F.5241 ; 45WCrSi8	10
–	SKD5	3Ch2W8F	F.5323 ; X30WCrV9	10
2310	–	–	F.5211 ; X160CrMoV12	10
–	SKT4	5ChNM	F.520S	10
–	–	–	–	10
–	SKS43	–	–	10
2723	SKH55	2723	R6M5K5	10
–	SKH3	–	F.5530 ; 18-1-1-5	10
2722	SKH9	(R6AM5) ; R6M5	F.5603 ; 6-5-2	10
2782	–	–	F0.5607 ; 18-0-1	10
–	SKH2	R18	F0.5520 ; 18-0-1	10

Werkstoffvergleichstabelle (Fortsetzung)

Materialgruppe	VardeX Nr.	USA AISI/SAE	Deutschland W.-Nr.	Deutschland DIN	Großbritannien BS	Frankreich AFNOR	ItalienUNI
M Edelstahl	12	403	1.4000	X6Cr13	403S17	Z6C13	X6Cr13
	12	-	1.4001	X7Cr14	-	-	-
	12	410	1.4006	X10Cr13	410S21	Z10C14	X12Cr13
	12	430	1.4016	X6Cr17	430S15	Z8C17	X8Cr17
	12	-	1.4027	G-X20Cr14	420C29	Z20C13M	-
	12	-	1.4034	X46Cr13	420S45	Z40CM;Z38C13M	X40Cr14
	12	431	1.4057	X20CrNi172	431S29	Z15CNi6.02	X16CrNi16
	12	430	1.4104	X12CrMoS17	-	Z10CF17	X10CrS17
	12	434	1.4113	X6CrMo171	434S17	Z8CD17.01	X8CrMo17
	12	-	1.4313	X5CrNi134	425C11	Z4CND13.4M	-
	12	-	1.4408	G-X6CrNiMo18 10	316C16	-	-
	12	HW3	1.4718	X45CrSi93	401S45	Z45CS 9	X45CrSi8
	12	405	1.4724	X10CrAl13	403S17	Z10C13	X101CrAl12
	11	-	1.4742	X10CrAl18	430S15	Z12CAS18	X8Cr17
	12	HNV6	1.4747	X80CrNiSi20	443S65	Z80CSN20.02	X80CrSiNi20
	11	446	1.4762	X10CrAl24	-	Z10CAS24	X16Cr26
	13	304	1.4301	X5CrNi18 10	304S15	Z6CN18.09	X5CrNi1810
	13	303	1.4305	X10CrNiSi18 9	303S21	Z10CNF 18.09	X10CrNiS 18.09
	13	304L	1.4306	X2CrNi19 11	304S12;304C12	Z2CN18.10;Z3CN 19.10	X2CrNi18.11
	13	CF8	1.4308	G-X6CrNi18 9	304C15	Z6CN18.10M	-
	13	301	1.4310	X12CrNi177	301S21	Z12CN 17.07	X1 2CrNi1 707
	13	304LN	1.4311	X2CrNi18 10	304S62	Z2CN18.10	-
	13	316	1.4401	X5CrNiMo17122	316S16	Z6CND17.11	X5CrNiMo17 12
	13	316LN	1.4429	X2CrNiMoNi17133	-	Z2CND17.13	-
	13	316L	1.4435	X2CrNiMo18143	316S12	Z2CND17.13	X2CrNiMo17 13
	13	317L	1.4438	X2CrNiMo17133	317S12	Z2CND19.15	X2CrNiMo18 16
	13	329	1.4460	X8CrNiMo275	-	-	-
	12	321	1.4541	X6CrNiTi18 10	2337	Z6CNT18.10	X6CrNiTi18 11
	12	347	1.4550	X6CrNiNb18 10	347S17	Z6CNNb18.10	X6CrNiNb18 11
	12	316Ti	1.4571	X6CrNiMoTi17122	320S17	Z6NDT1 7.12	X6CrNiMoTi17 12
	12	-	1.4581	G-X5CrNiMoNb18 10	318C17	Z4CNDNb18 12M	XG8CrNiMo18 11
	12	318	1.4583	X10CrNiMoNb18 12	-	Z6CNDNb17 13B	X6CrNiMoNb17 13
	13	309	1.4828	X15CrNiSi20 12	309S24	Z15CNS20.12	-
	13	310S	1.4845	X12CrNi25 21	310S24	Z12CN25 20	X6CrNi25 20
	13	330	1.4864	X12NiCr36 16	-	Z12NCS35.16	-
13	-	1.4865	G-X40NiCrSi38 18	330C11	-	XG50NiCr39 19	
13	EV8	1.4871	X53CrMnNiN2 19	349S54;321S12	Z52CMN21.09	X53CrMnNiN219	
13	321	1.4878	X12CrNiTi18 9	321S320	Z6CNT18.12B	X6CrNiTi1811	
30	No 20 B	0.6010	GG10	-	Ft 10 D	-	
30	No 25 B	0.6015	GG15	Grade 150	Ft 15 D	-	
30	No 30 B	0.6020	GG20	Grade 220	Ft 20 D	-	
29	No 35 B; No 40 B	0.6025	GG25	Grade 260	Ft 25 D	-	
29	No 45 B	0.6030	GG30	Grade 300	R 30 D	-	
29	No 50 B	0.6035	GG35	Grade 350	Ft 35 D	-	
29	No 55 B	0.6040	GG40	Grade 400	Ft 40 D	-	
29	ASTM	-	DIN4694	3468: 1974	-	-	
29	A436-72	-	GGL-	-	A32-301	-	
29	Type 2	-	NiCr20 2	L-NiCr 20 2	L-NC 20 2	-	
30	60-40-18	0.7040	GGG 40	SNG 420/12	FCS 400-12	GS 370-17	
30	-	0.7043	GGG 40.3	SNG 370/17	FGS 370-17	-	
30	-	0.7033	GGG 35.3	-	-	-	
31	80-55-06	0.7050	GGG 50	SNG 500/7	FGS 500-7	GS 500	
31	-	0.7060	GGG 60	SNG 600/3	FGS 600-3	-	
31	100-70-03	0.7070	GGG70	SNG 700/2	FGS 700-2	GS 700-2	
31	-	-	DIN 1694	-	L-NM 13 7	-	
31	Type 2	-	GGG NiMn 13 7	L-NiMn 13 7	L-NC 20 2	-	
31	-	-	GGG NiCr 20 2	L-NC 20 2	-	-	
28	32510	0.8135	GTS-35	B 340/12	MN 35-10	-	
29	40010	0.8145	GTS-45	P 440/7	-	-	
29	50005	0.8155	GTS-55	P 510/4	MP50-5	-	
29	70003	0.8165	GTS-65	P 570/3	MP 60-3	-	
29	80002	0.8170	GTS-70	P690/2	MP 70-2	-	
36	-	-	G-AlSi12	LM20	-	-	
36	-	-	GD-AlSi12	-	-	-	
36	-	-	GD-AlSi8Cu3	LM24	-	-	
36	-	-	G-AlSi10Mg	LM9	-	-	
36	-	-	G-AlSi12	LM6	-	-	
19	330	1.4864	X12NiCrSi	-	Z12NCS35.16	-	
19	-	1.4865	G-X40NiCrSi	330C11	-	XG50NiCr	
19	5,390 A	2.4603	-	-	NC22FeD	-	
19	-	2.4630	NiCr20Ti	HR5, 203-4	NC20T	-	
19	5666	2.4856	NiCr22Mo9N	-	NC22FeDNB	-	
19	5537 C	LW2.496	CoCr20W15	-	KC20WN	-	
19	4676	2.4375	NiCu30Al	3072-76	-	-	
19	-	2.4631	NiCr20TiAk	Hr40,601	NC20TA	-	
19	AMS 5399	2.4973	NiCr19Co11	-	NC19KDT	-	
21	5391	LW2.467	S-NiCr13Al16	3146-3	NC12AD	-	
21	5660	LW2.466	NiCr19Fe19	HR8	NC19FeNb	-	
21	5383	LW2.466	NiCr19Fe19	-	NC20K14	-	
21	-	-	CoCr22W14	-	KC22WN	-	
21	-	LW2.467	NiCo15Cr10	-	-	-	
23	-	-	TiAl14Mo4Sn4Si0.5	-	-	-	
23	-	-	TiAl5Sn2.5	TA14/17	T-A5E	-	
23	-	-	TiAl6V4	TA10-13/TA2	T-A6V	-	
23	-	-	TiAl6V4ELI	TA11	-	-	

Gewindedrehen
Technische Daten

M
Edelstahl

K
Gußeisen

N(K)
Nichteisen-
Metalle
Metalle

S(M)
Hitzebe-
ständige
Material

Schweden SS	Japan JIS	Russland GOST	Spanien UNE	VardeX Nr.	
2301	SUS403	08Ch13	F.3110-X6Cr13 ; F.8401-AM-X12Cr13	12	M
-	-	08Ch13	F.3110-X6Cr13 ; F.8401-AM-X12Cr13	12	
2302	SUS410	12Ch13 ; 15Ch13L	F.3401-X10Cr13	12	
2320	SUS430	12Ch17	F.3113-X6Cr17	12	
-	SCS2	20Ch13L	-	12	
2304	SUS420J2	40Ch13	F.3405-X45Cr13	12	
2321	SUS431	20Ch17N2	F.3427-X19CrNi172	12	
2383	SUS430F	-	F.3117-X10CrS17 ; F.3413-X14CrMoS17	12	
2325	SUS434	-	F.3116-X6CrMo171	12	
-	SCS5	-	-	12	
-	SCS14	07Ch18N10G2S2M2L	F.8414-AM-X7CrNiMo2010	12	
-	SUH1	40Ch9S2	F.3220-X45CrSi09-03	12	
-	SUS405	10Ch13SJ	F.3152-X10CrAl13	12	
-	SUH21	15Ch18SJ	F.3153-X10CrAl18	11	
-	SUH4	-	F.3222-X80CrSiNi20-02	12	
2322	SUH446	-	F.3154-X10CrAl24	11	
2332	SUS304	08Ch18N10	F.3551-X5CrNi1811;F.3541-X5CrNi1810 ; F.3504-X6CrNi1910	13	
2346	SUS303	-	F.3508-X10CrNiS18-09	13	
2352	SCS19; SUS304L	03Ch18N11	F.3503-X2CrNi1810	13	
2333	SCS13	07Ch18N9L	-	13	
2331	SUS301	-	F.3517-X12CrNi177	13	
2371	SUS304LN	-	F.3541-X2CrNi1810	13	
2347	SUS316	-	F.3534-X5CrNiMo17122	13	
2375	SUS316LN	-	F.3543-X2CrNiMoN17133	13	
2353	SCS16	03Ch17N14M3	F.3533-X2CrNiMo17132	13	
2367	SUS317L	-	F.3539-X2CrNiMo18164	13	
2324	SUS329L;	-	F.3309-X8CrNiMo27-05; F.3552-X8CrNiMo266	13	
58B	SUS321	06Ch18N10T; 08Ch18N10T; 09Ch18N10T; 12Ch18N10T	F.3523-X6CrNiTi1810	12	
2338	SUS347	08Ch18N12B	F.3524-X6CrNiNb1810	12	
2350	-	10Ch17N13M2T	F.3535-X6CrNiMoTi17122	12	
-	SCS22	-	-	12	
-	-	-	-	12	
-	SUH309	20Ch20N14S2	F.3312-X15CrNiSi20-12	13	
2361	SUH310	20Ch23N18	-	13	
-	SUH330	-	F.3313-X12CrNiSi36-16	13	
-	SCH15	-	-	13	
-	SUH35,SUH36,SU321	55Ch20G9AN4	F.3217-X53CrMnNiN21-09	13	
-	-	-	-	13	
01 10	-	C410	FG10	30	
01 15	-	C415	FG15	30	
01 20	-	C420	FG20	30	
01 25	-	C425	FG25	29	
01 30	-	C430	FG30	29	
01 35	-	C435	FG35	29	
01 40	-	C440	-	29	
MB	-	-	-	29	
ISO -215	-	-	-	29	
523	-	-	-	29	
07 17-02	-	VC42-12	-	30	
07 17-12	-	VC42-12	-	30	
07 17-15	-	-	-	30	
07 27-02	-	VC50-2	-	31	
07 32-03	-	VC60-2	-	31	
07 37-01	-	VC70-2	-	31	
07 72	-	-	-	31	
07 76	-	-	-	31	
-	-	-	-	31	
08 15	-	-	-	28	
08 52	-	-	-	29	
08 54	-	-	-	29	
08 58	-	-	-	29	
08 62	-	-	-	29	
4260	-	-	-	36	
4247	-	-	-	36	
4250	-	-	-	36	
4253	-	-	-	36	
4261	-	-	-	36	
-	SUH 330	-	F.3313-X12CrNiSi36-16	19	
-	SCH 15	-	-	19	
-	-	-	-	19	
-	-	-	-	19	
-	-	-	-	19	
-	-	-	-	19	
-	-	-	-	19	
-	-	-	-	19	
-	-	-	-	19	
-	-	-	-	19	
-	-	-	-	19	
-	-	-	-	21	
-	-	-	-	21	
-	-	-	-	21	
-	-	-	-	21	
-	-	-	-	21	
-	-	-	-	23	
-	-	-	-	23	
-	-	-	-	23	
-	-	-	-	23	

K

N

S

Problemlösung

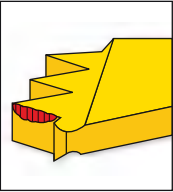
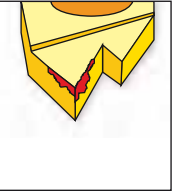
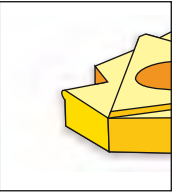
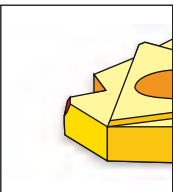
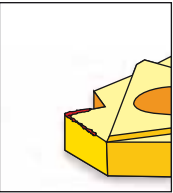
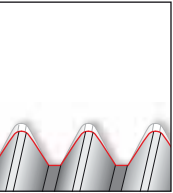
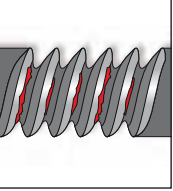
Problem	Mögliche Ursache	Lösung
 <p>Erhöhter Freiflächenverschleiß</p>	<p>Schnittgeschwindigkeit zu hoch -----></p> <p>Schnitttiefe zu gering/ zu viele Durchgänge -----></p> <p>Ungeeignete Hartmetallsorte -----></p> <p>Nicht ausreichende Kühlung -----></p>	<p>- Verringern Sie die Schnittgeschwindigkeit / Verwenden Sie eine beschichtete Platte</p> <p>- Erhöhen Sie die Schnitttiefe pro Durchgang</p> <p>- Verwenden Sie eine beschichtete Hartmetallsorte</p> <p>- Erhöhen Sie den Kühlmittelfluss</p>
 <p>Ungleichmäßiger Verschleiß entlang der Schneidkante</p>	<p>Falscher Teilungswinkel -----></p> <p>Falsche Zustellungsmethode -----></p>	<p>- Verwenden Sie die richtige Unterlegplatte</p> <p>- Wenden Sie die wechselseitige Zustellung an</p>
 <p>Extreme plastische Verformung</p>	<p>Schnitttiefe zu hoch -----></p> <p>Nicht ausreichende Kühlung -----></p> <p>Schnittgeschwindigkeit zu hoch -----></p> <p>Ungeeignete Hartmetallsorte -----></p> <p>Radius an Schneidecke zu klein -----></p>	<p>- Verringern Sie die Schnitttiefe / Erhöhen Sie die Anzahl der Durchgänge</p> <p>- Erhöhen Sie den Kühlmittelfluss</p> <p>- Reduzieren Sie die Schnittgeschwindigkeit</p> <p>- Verwenden Sie ein härteres Hartmetall</p> <p>- Benutzen Sie eine Platte mit einem größeren Radius, wenn möglich</p>
 <p>Bruch der Schneidkante</p>	<p>Schnitttiefe zu hoch -----></p> <p>Extreme plastische Verformung -----></p> <p>Nicht ausreichende Kühlung -----></p> <p>Ungeeignete Hartmetallsorte -----></p> <p>Instabilität -----></p>	<p>- Verringern Sie die Schnitttiefe / Erhöhen Sie die Anzahl der Durchgänge</p> <p>- Verwenden Sie ein härteres Hartmetall</p> <p>- Erhöhen Sie den Fluss und/oder korrigieren Sie die Flussrichtung</p> <p>- Verwenden Sie ein härteres Hartmetall</p> <p>- Überprüfen Sie die Stabilität des Systems</p>
 <p>Aufbauschniede</p>	<p>Falsche Schnittgeschwindigkeit -----></p> <p>Ungeeignete Hartmetallsorte -----></p>	<p>- Verändern Sie die Schnittgeschwindigkeit</p> <p>- Verwenden Sie beschichtetes Hartmetall</p>
 <p>Gewindeprofil zu flach</p>	<p>Das Werkzeug befindet sich nicht auf Spitzenhöhe -----></p> <p>Die Platte bearbeitet nicht die Gewindespitze -----></p> <p>Abgenutzte Platte -----></p>	<p>- Verändern Sie die Spitzenhöhe des Werkzeugs</p> <p>- Messen Sie den Werkstückdurchmesser</p> <p>- Wechseln Sie früher die Schneidkante</p>
 <p>Geringe Oberflächengüte</p>	<p>Schnittgeschwindigkeit zu niedrig -----></p> <p>Falsche Unterlegplatte -----></p> <p>Ungeeignete Zustellungsmethode -----></p>	<p>Erhöhen Sie die Schnittgeschwindigkeit</p> <p>Wählen Sie die richtige Unterlegplatte</p> <p>Verwenden Sie die wechselseitige oder die radiale Zustellung</p>



Einstecken





■ Vardex Bestellnummernsystem.....	Seite 149
■ Aussen - DIN 471 Sicherungsringe für Schäfte.....	Seite 150
■ Innen - DIN 472 Sicherungsringe für Bohrungen.....	Seite 151
■ Innen - DIN 472 Sicherungsringe für Bohrungen - Micro.....	Seite 152
■ Aussen/ Innen - DIN 7993 Runddraht- Sprengringe.....	Seite 154
■ Aussen/ Innen - DIN 7993 Runddraht- Sprengringe - Micro.....	Seite 155
■ Aussen - DIN 76 Gewindefreistiche.....	Seite 156
■ Innen - DIN 76 Gewindefreistiche.....	Seite 157
■ Innen - DIN 3770 - Stechen - Micro.....	Seite 157
■ Innen - DIN 471 DIN 472 - Axial- Stechen - Micro.....	Seite 158
■ Einstechen - Microscope.....	Seite 159
■ Einstechen Rund - Microscope.....	Seite 160
■ Axial einstechen - Microscope.....	Seite 161
■ Vorstechen - Microscope.....	Seite 162

Vardex Bestellnummernsystem

Einstechplatten

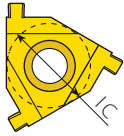
5	L	I	R	1.1	-	D472	-	1.3	VKP
1	2	3	4	5	6	7	6	8	9

1- Plattengrösse 5.0L - IC5,0L 2 - IC1/4" 3 - IC3/8" 4 - IC1/2" 5 - IC5/8" 	2 - Plattentyp L 	3 - Platte E - Aussen I - Innen	4 - RH / LH Platte R - Rechte Platte R - Linke Platte
---	---	--	--

5 - Norm Nutbreite 0.8 - 2.15 (mm)	6 - Profilart C - Vollprofil	7 - Norm DIN 471 Teilprofil DIN 471 DIN 472 Teilprofil DIN 472 DIN 7993 Teilprofil DIN 7993 DIN 76 ST, DIN 76 SH DIN 3770	8 - Stechtiefe 0.33 - 2.0 (mm)	9 - Hartmetallsorte VTX VKP (für Mini) VHX (für Mini)
--	--	--	--	---

Micro Stecheinsätze - Zweiseitig

4.0	S	I	R	0.7	A	-	D471/D472	-	1.4	VMX
1	2	3	4	5	6		7		8	9

1- Einsatz Ø 3.0 - 3.0 mm 4.0 - 4.0 mm 6.0 - 6.0 mm 8.0 - 8.0 mm 10.0 - 10.0 mm	2 - Plattentyp S - Micro Einsatz	3 - Platte I - Innen	4 - RH/LH Platte R - Rechte Platte R - Linke Platte	5 - Norm Nutbreite 0.9 - 2.15 (mm)
---	--	--------------------------------	--	--

6 - Einsatzlänge A - axial S - kurz M - mittel L - lang	7 - Norm DIN 471 DIN 472 DIN 7993 DIN 76SH, DIN 76ST DIN 3770S, DIN 3770D DIN 471/472 - Face Grooving	8 - Stechtiefe 0.5 - 1.5 (mm)	9 - Hartmetallsorte VMX
--	--	---	-----------------------------------

Einstechplatten microscope- Einseitig

M	4	42	GS	W	100	L16	R	VBX
1	2	3	4	5	6	7	8	9

1- Produktlinie M - Microscope	2- Plattengrösse 4, 5, 6, 7	3 - Min Bohrungsdurchmesser 4.2 - 7.2
--	---------------------------------------	---

4 - Anwendung GS - Einstechen GR - Einstechen Rund FG - Axial einstechen innen FP - Axial einstechen aussen PP - Vorstechen	5-6 - Breite / Radius <table border="1"> <tr> <th>Breite</th> <th>Radius</th> </tr> <tr> <td>1.0-3.0 (mm)</td> <td>0.5-1.0 (mm)</td> </tr> </table>	Breite	Radius	1.0-3.0 (mm)	0.5-1.0 (mm)	7 - Auskraglänge L10 - L35	8 - LH oder RH R - RH L - LH	9 - Hartmetallsorten VBX
Breite	Radius							
1.0-3.0 (mm)	0.5-1.0 (mm)							

DIN 471 Sicherungsringe für Schäfte

Aussen

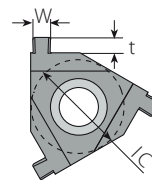
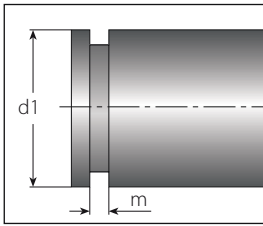

Standard
(Teilprofil)

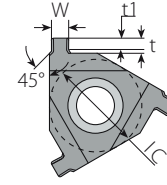

Standard
(Vollprofil)

Standard (Teilprofil)



Plattengrösse	Bestellnummer	Norm	Abmessungen mm			Unterlegplatte	Halter
IC	RH	m (H13)	W	t			
3/8"	3ER1.10-D471-1.30...	1.10	1.19	1.3	YE3M-1.5N	AL...-3	
	3ER1.30-D471-1.50...	1.30	1.39	1.5			
	3ER1.60-D471-1.85...	1.60	1.69	1.8			
	3ER1.85-D471-2.00...	1.85	1.94	2.0			

Profilangebot auch auf IC 1/4", 1/2" und 5/8" erhältlich, Platten auf Anfrage.

Standard (Vollprofil)



Plattengrösse	Bestellnummer	Norm	Abmessungen mm				Unterlegplatte	Halter
IC	RH	m (H13)	d1	W	t1	t		
3/8"	3ER1.10C-D471-0.35...	1.10	15	1.19	0.33	0.35	YE3M-1.5N	AL...-3
	3ER1.10C-D471-0.40...	1.10	16-17	1.19	0.36	0.40		
	3ER1.30C-D471-0.50...	1.30	18-22	1.39	0.44	0.50		
	3ER1.30C-D471-0.55...	1.30	24-26	1.39	0.45	0.55		
	3ER1.60C-D471-0.70...	1.60	28-30	1.69	0.60	0.70		
	3ER1.60C-D471-0.85...	1.60	32-34	1.69	0.75	0.85		
	3ER1.60C-D471-1.00...	1.60	35	1.69	0.85	1.00		
	3ER1.85C-D471-1.00...	1.85	36-38	1.94	0.85	1.00		
	3ER1.85C-D471-1.25...	1.85	40-48	1.94	1.10	1.25		
	3ER2.15C-D471-1.50...	2.15	50-63	2.24	1.35	1.50		

Profilangebot auch auf IC 1/4", 1/2" und 5/8" erhältlich, Platten auf Anfrage.

DIN 472 Sicherungsringe für Bohrungen

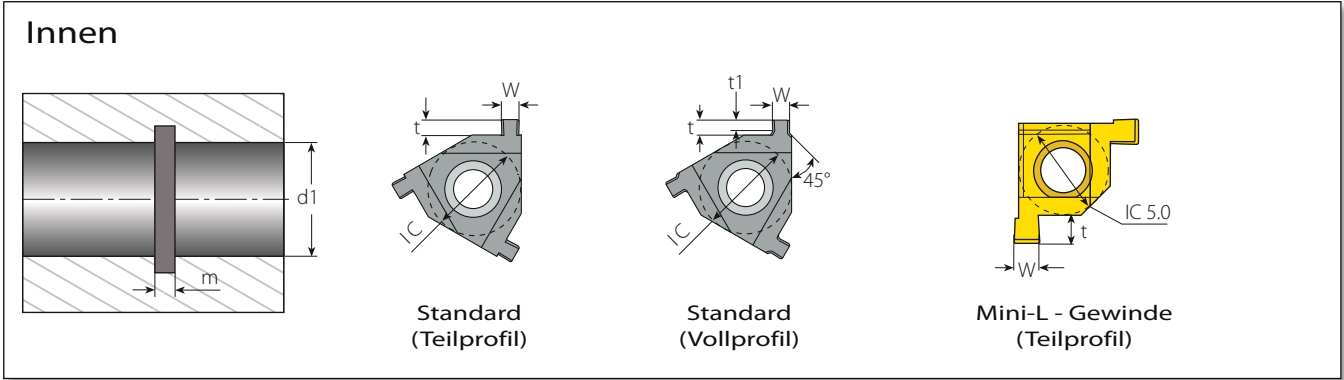

Standard (Teilprofil)



Plattengröße	Bestellnummer	Norm	Abmessungen mm		Unterlegplatte	Halter
IC		m (H13)	W	t		
3/8"	3IR1.10-D472-1.30...	1.10	1.19	1.30	Y13M-1.5N	AVR...-3
	3IR1.30-D472-1.50...	1.30	1.39	1.50		
	3IR1.60-D472-1.80...	1.60	1.69	1.80		
	3IR1.85-D472-2.00...	1.85	1.94	2.00		

Profilangebot auch auf IC 1/4", 1/2" und 5/8" erhältlich, Platten auf Anfrage.
Für minimalen Bohrungsdurchmesser bitte Seite 165 beachten.

Standard (Vollprofil)



Plattengröße	Bestellnummer	Norm	Abmessungen mm				Unterlegplatte	Halter
IC		m (H13)	d1	W	t1	t		
3/8"	3IR1.10C-D472-0.50...	1.10	18-22	1.19	0.36	0.50	Y13M-1.5N	AVR...-3
	3IR1.30C-D472-0.60...	1.30	24-26	1.39	0.44	0.60		
	3IR1.30C-D472-0.70...	1.30	28-30	1.39	0.60	0.70		
	3IR1.30C-D472-0.85...	1.30	31-34	1.39	0.75	0.85		
	3IR1.60C-D472-0.85...	1.60	34	1.69	0.75	0.85		
	3IR1.60C-D472-1.00...	1.60	35-38	1.69	0.85	1.00		
	3IR1.85C-D472-1.25...	1.85	40-48	1.94	1.10	1.25		
	3IR2.15C-D472-1.50...	2.15	50-63	2.24	1.35	1.50		

Profilangebot auch auf IC 1/4", 1/2" und 5/8" erhältlich, Platten auf Anfrage.
Für minimalen Bohrungsdurchmesser bitte Seite 165 beachten.

Mini- L Stechen (Teilprofil)



Plattengröße	Bestellnummer	Norm	Abmessungen mm		Min. Bohrungsdurchm. (mm)	Halter
IC		m (H13)	W	t		
5.0L	5LIR0.9-D472-0.7...	0.9	0.99	0.7	8.0	.NVR10...-5L
	5LIR1.1-D472-1.0...	1.1	1.19	1.0		
	5LIR1.3-D472-1.5...	1.3	1.39	1.5		

DIN 472 Sicherungsringe für Bohrungen



Innen

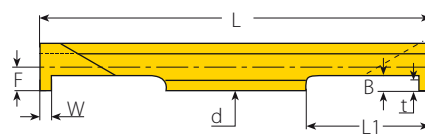
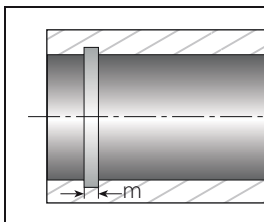

RH - Zweiseitig

Micro - Zweiseitig

Einsatzdurchmesser	Bestellnummer	Norm	Abmessungen mm						Min. Bohrungsdurchmesser	Halter
d [mm]	RH	m (H13)	W	L1	L	B	t	F	mm	
3.0	3.0SIR0.90S-D472-0.5...	0.90	0.99	9.0	36.0	0.8	0.5	1.40	3.2	SMC..-3.0
	3.0SIR0.90M-D472-0.5...	0.90	0.99	16.0	50.0					
	3.0SIR1.10S-D472-0.5...	1.10	1.19	9.0	36.0					
	3.0SIR1.10M-D472-0.5...	1.10	1.19	16.0	50.0					
4.0	4.0SIR0.90S-D472-1.1...	0.90	0.99	9.0	36.0	1.4	1.1	1.90	4.1	SMC..-4.0
	4.0SIR0.90M-D472-1.1...	0.90	0.99	16.0	50.0					
	4.0SIR0.90L-D472-1.1...	0.90	0.99	21.0	60.0					
	4.0SIR1.10S-D472-1.1...	1.10	1.19	9.0	36.0					
	4.0SIR1.10M-D472-1.1...	1.10	1.19	16.0	50.0					
	4.0SIR1.10L-D472-1.1...	1.10	1.19	21.0	60.0					
	4.0SIR1.30S-D472-1.1...	1.30	1.39	9.0	36.0					
	4.0SIR1.30M-D472-1.1...	1.30	1.39	16.0	50.0					
	4.0SIR1.30L-D472-1.1...	1.30	1.39	21.0	60.0					
	4.0SIR1.60S-D472-1.1...	1.60	1.69	9.0	36.0					
	4.0SIR1.60M-D472-1.1...	1.60	1.69	16.0	50.0					
	4.0SIR1.60L-D472-1.1...	1.60	1.69	21.0	60.0					
6.0	6.0SIR0.90S-D472-1.5...	0.90	0.99	9.0	36.0	1.8	1.5	2.90	6.1	SMC..-6.0
	6.0SIR0.90M-D472-1.5...	0.90	0.99	16.0	50.0					
	6.0SIR0.90L-D472-1.5...	0.90	0.99	21.0	60.0					
	6.0SIR1.10S-D472-1.5...	1.10	1.19	9.0	36.0					
	6.0SIR1.10M-D472-1.5...	1.10	1.19	16.0	50.0					
	6.0SIR1.10L-D472-1.5...	1.10	1.19	21.0	60.0					
	6.0SIR1.30S-D472-1.5...	1.30	1.39	9.0	36.0					
	6.0SIR1.30M-D472-1.5...	1.30	1.39	16.0	50.0					
	6.0SIR1.30L-D472-1.5...	1.30	1.39	21.0	60.0					
	6.0SIR1.60S-D472-1.5...	1.60	1.69	9.0	36.0					
	6.0SIR1.60M-D472-1.5...	1.60	1.69	16.0	50.0					
	6.0SIR1.60L-D472-1.5...	1.60	1.69	21.0	60.0					
	6.0SIR1.85S-D472-1.5...	1.85	1.94	9.0	36.0					
	6.0SIR1.85M-D472-1.5...	1.85	1.94	16.0	50.0					
	6.0SIR1.85L-D472-1.5...	1.85	1.94	21.0	60.0					
	6.0SIR2.15S-D472-1.5...	2.15	2.24	9.0	36.0					
	6.0SIR2.15M-D472-1.5...	2.15	2.24	16.0	50.0					
	6.0SIR2.15L-D472-1.5...	2.15	2.24	21.0	60.0					

Weiter Nächste Seite ►

DIN 472 Sicherungsringe für Bohrungen (Fortsetzung)

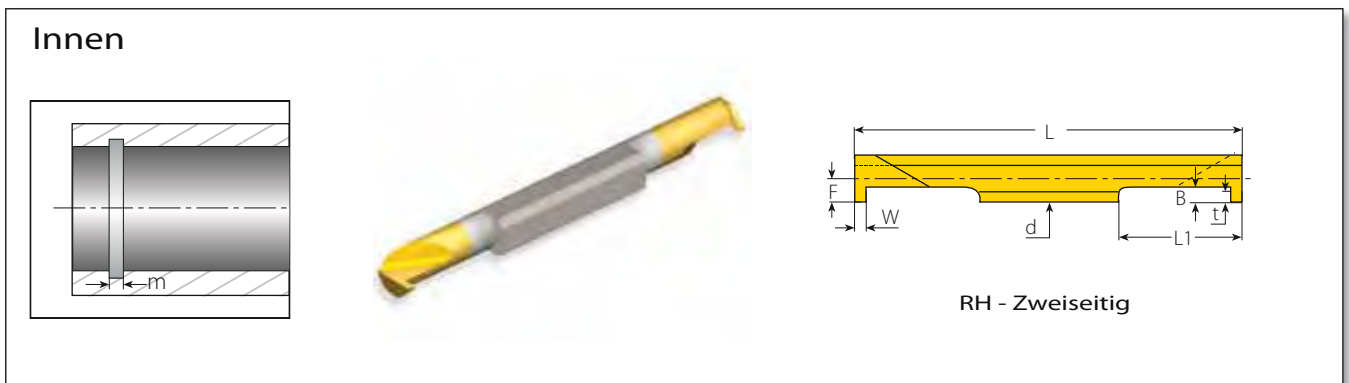

Micro - Zweiseitig (Fortsetzung)

Einsatzdurchmesser	Bestellnummer	Norm	Abmessungen mm					Min. Bohrungsdurchmesser	Halter	
d [mm]	RH	m (H13)	W	L1	L	B	t	F	mm	
8.0	8.0SIR1.10M-D472-2.0...	1.10	1.19	20	70	2.5	2.0	3.9	8.4	SMC.-8.0
	8.0SIR1.30M-D472-2.0...	1.30	1.39	20	70	2.5	2.0			
	8.0SIR1.60M-D472-2.5...	1.60	1.69	20	70	3.0	2.5			
	8.0SIR1.85M-D472-2.5...	1.85	1.94	20	70	3.0	2.5			
	8.0SIR2.15M-D472-3.0...	2.15	2.24	20	70	3.5	3.0			
	8.0SIR2.65M-D472-3.5...	2.65	2.74	20	70	4.0	3.5			
	8.0SIR3.15M-D472-3.5...	3.15	3.28	20	70	4.0	3.5			
10.0	10.0SIR1.30M-D472-3.5...	1.30	1.39	25	80	4.0	3.5	4.9	10.4	SMC.-10.0
	10.0SIR1.60M-D472-3.5...	1.60	1.69	25	80					
	10.0SIR1.85M-D472-3.5...	1.85	1.94	25	80					
	10.0SIR2.15M-D472-3.5...	2.15	2.24	25	80					
	10.0SIR2.65M-D472-3.5...	2.65	2.74	25	80					
	10.0SIR3.15M-D472-3.5...	3.15	3.28	25	80					
	10.0SIR4.15M-D472-3.5...	4.15	4.28	25	80					
10.0SIR5.15M-D472-3.5...	5.15	5.28	25	80						

Einstechplatten

DIN 7993 Runddraht- Sprengringe

Aussen

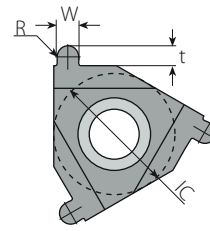
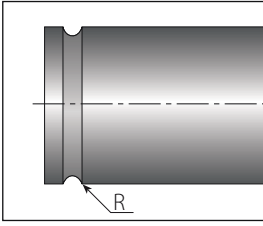

Standard
(Teilprofil)

Standard (Teilprofil für Schäfte)



Plattengröße	Bestellnummer	Abmessungen mm			Unterlegplatte	Halter
IC	RH	R	W	t		
3/8"	3ER0.40-D7993-0.60...	0.40	0.80	0.60	YE3M-1.5N	AL..-3
	3ER0.60-D7993-0.80...	0.60	1.20	0.80		
	3ER0.90-D7993-1.10...	0.90	1.80	1.10		
	3ER1.00-D7993-1.20...	1.00	2.00	1.20		

Profilangebot auch auf IC 1/4", 1/2" und 5/8" erhältlich, Platten auf Anfrage.

Einstechplatten

Innen

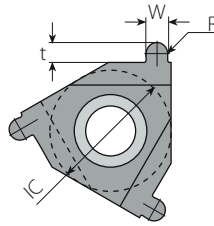
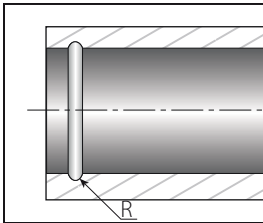

Standard
(Teilprofil)

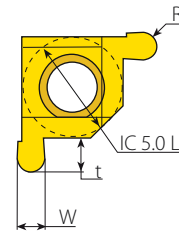

Mini-L - Gewinde
(Teilprofil)

Standard (Teilprofil für Bohrungen)



Plattengröße	Bestellnummer	Abmessungen mm			Unterlegplatte	Halter
IC	RH	R	W	t		
3/8"	3IR0.60-D7993-0.80...	0.60	1.20	0.80	Y13M-1.5N	AVR..-3
	3IR0.90-D7993-1.10...	0.90	1.80	1.10		
	3IR1.00-D7993-1.20...	1.00	2.00	1.20		

Profilangebot auch auf IC 1/4", 1/2" und 5/8" erhältlich, Platten auf Anfrage.
Für minimalen Bohrungsdurchmesser bitte Seite 165 beachten.

Mini-L (Teilprofil für Bohrungen)



Plattengröße	Bestellnummer	Abmessungen mm			Min. Bohrungsdurchmesser	Halter
IC	RH	R	W	t	mm	
5.0L	5LIR0.4-D7993-0.8...	0.4	0.8	0.8	8.0	.NVR10-5L
	5LIR0.6-D7993-1.0...	0.6	1.2	1.0		

DIN 7993 Runddraht- Sprengringe



Innen

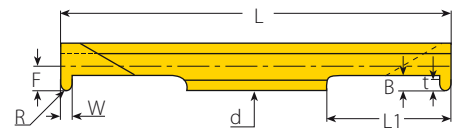
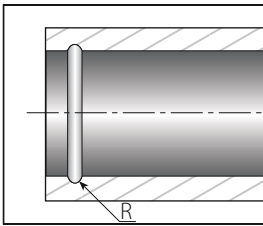

RH - Zweiseitig

Micro (Teilprofil) - Zweiseitig

Einsatzdurchmesser d [mm]	Bestellnummer RH	Norm R	Abmessungen mm						Min. Bohrungsdurchmesser mm	Halter
			W	L1	L	B	t	F		
3.0	3.0SIR0.4S-D7993-0.6...	0.40	0.80	9.0	36.0	0.8	0.6	1.40	3.2	SMC...-3.0
	3.0SIR0.4M-D7993-0.6...	0.40	0.80	16.0	50.0					
4.0	4.0SIR0.4S-D7993-0.6...	0.40	0.80	9.0	36.0	0.9	0.6	1.90	4.1	SMC...-4.0
	4.0SIR0.4M-D7993-0.6...	0.40	0.80	16.0	50.0					
	4.0SIR0.4L-D7993-0.8...	0.40	0.80	21.0	60.0	1.1	0.8			
	4.0SIR0.6S-D7993-0.8...	0.60	1.20	9.0	36.0					
	4.0SIR0.6M-D7993-0.8...	0.60	1.20	16.0	50.0	1.4	1.1			
	4.0SIR0.6L-D7993-0.8...	0.60	1.20	21.0	60.0					
	4.0SIR0.9S-D7993-1.1...	0.90	1.80	9.0	36.0	1.4	1.1			
	4.0SIR0.9M-D7993-1.1...	0.90	1.80	16.0	50.0					
4.0SIR0.9L-D7993-1.1...	0.90	1.80	21.0	60.0	1.4	1.1				
6.0SIR0.9S-D7993-1.1...	0.90	1.80	9.0	36.0						
6.0	6.0SIR0.9M-D7993-1.1...	0.90	1.80	16.0	50.0	1.5	1.2	2.90	6.1	SMC...-6.0
	6.0SIR0.9L-D7993-1.1...	0.90	1.80	21.0	60.0					
	6.0SIR1.0S-D7993-1.2...	1.00	2.00	9.0	36.0	1.6	1.3			
	6.0SIR1.0M-D7993-1.2...	1.00	2.00	16.0	50.0					
	6.0SIR1.0L-D7993-1.2...	1.00	2.00	21.0	60.0	1.6	1.3			
	6.0SIR1.1S-D7993-1.3...	1.10	2.20	9.0	36.0					
	6.0SIR1.1M-D7993-1.3...	1.10	2.20	16.0	50.0	1.6	1.3			
	6.0SIR1.1L-D7993-1.3...	1.10	2.20	21.0	60.0					
8.0	8.0SIR0.9M-D7993-2.0...	0.90	1.80	20.0	70.0	2.5	2.0	3.90	8.4	SMC...-8.0
	8.0SIR1.1M-D7993-2.0...	1.10	2.20	20.0	70.0					
	8.0SIR1.4M-D7993-2.0...	1.40	2.80	20.0	70.0					
10.0	10.0SIR1.4M-D7993-2.9...	1.40	2.80	25.0	80.0	3.4	2.9	4.90	10.4	SMC...-10.0
	10.0SIR1.8M-D7993-2.9...	1.80	3.60	25.0	80.0					

Einstechplatten

DIN 76 Gewindefreistiche

(Für metrische ISO Gewinde gemäß DIN 13)

Aussen

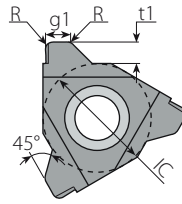
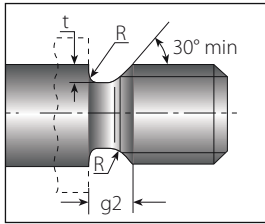

Normal - Typ A

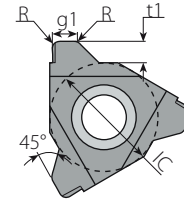

Kurz - Typ B

Standard (Regelfall - Typ A)

Plattengröße	Bestellnummer	Teilung	Abmessungen mm					Unterlegplatte	Halter
			mm	R	g1	g2	t		
3/8"	3ER0.50-D76ST-0.40...	0.50	0.2	1.10	1.50	0.40	2.50	YE3M-1.5N	AL.-3
	3ER0.60-D76ST-0.50...	0.60	0.4	1.30	1.80	0.50	2.40		
	3ER0.70-D76ST-0.55...	0.70	0.4	1.55	2.10	0.55	2.20		
	3ER0.80-D76ST-0.65...	0.80	0.4	1.75	2.40	0.65	2.10		
	3ER1.00-D76ST-0.80...	1.00	0.6	2.20	3.00	0.80	1.90		
5/8"	5ER1.25-D76ST-1.00...	1.25	0.6	2.80	3.80	1.00	3.60	YE5M-1.5N	AL.-5
	5ER1.50-D76ST-1.15...	1.50	0.8	3.35	4.50	1.15	3.30		
	5ER1.75-D76ST-1.30...	1.75	1.0	4.00	5.30	1.30	3.00		
	5ER2.00-D76ST-1.50...	2.00	1.0	4.50	6.00	1.50	2.70		



Standard (Kurz - Typ B)

Plattengröße	Bestellnummer	Teilung	Abmessungen mm					Unterlegplatte	Halter
			mm	R	g1	g2	t		
3/8"	3ER1.00-D76SH-0.80...	1.00	0.6	1.20	2.00	0.80	2.50	YE3M-1.5N	AL.-3
	3ER1.25-D76SH-1.00...	1.25	0.6	1.50	2.50	1.00	2.30		
	3ER1.50-D76SH-1.15...	1.50	0.8	1.85	3.00	1.15	2.10		
	3ER1.75-D76SH-1.30...	1.75	1.0	2.20	3.50	1.30	1.90		
5/8"	5ER2.00-D76SH-1.50...	2.00	1.0	2.50	4.00	1.50	3.80	YE5M-1.5N	AL.-5
	5ER2.50-D76SH-1.80...	2.50	1.2	3.20	5.00	1.80	3.50		
	5ER3.00-D76SH-2.20...	3.00	1.6	3.80	6.00	2.20	3.10		



Profilangebot auch auf IC 1/4" und 1/2" erhältlich, Platten auf Anfrage.

DIN 76 Gewindefreistiche

(Für metrische ISO Gewinde gemäß DIN 13)

Innen

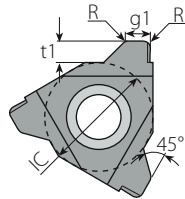
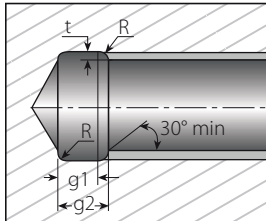

Normal - Typ C

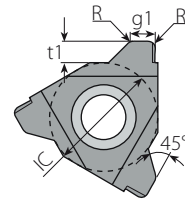

Kurz - Typ D

Standard (Regelfall - Typ C)



Plattengröße	Bestellnummer	Teilung	Abmessungen mm					Unterlegplatte	Halter
IC	RH	mm	R	g1	g2	t	t1		
3/8"	3IR0.50-D76ST-0.40...	0.50	0.2	1.10	1.50	0.40	2.50	Y13M-1.5N	AL...3
	3IR0.60-D76ST-0.50...	0.60	0.4	1.30	1.80	0.50	2.40		
	3IR0.70-D76ST-0.55...	0.70	0.4	1.55	2.10	0.55	2.20		
	3IR0.80-D76ST-0.65...	0.80	0.4	1.75	2.40	0.65	2.10		
	3IR1.00-D76ST-0.80...	1.00	0.6	2.20	3.00	0.80	1.90		

Profilangebot auch auf IC 1/4", 1/2" und 5/8" erhältlich, Platten auf Anfrage.
Für minimalen Bohrungsdurchmesser bitte Seite 165 beachten.

Standard (Kurz - Typ D)



Plattengröße	Bestellnummer	Teilung	Abmessungen mm					Unterlegplatte	Halter
IC	RH	mm	R	g1	g2	t	t1		
3/8"	3IR1.00-D76SH-0.80...	1.00	0.6	1.20	2.00	0.80	2.50	Y13M-1.5N	AL...3
	3IR1.25-D76SH-1.00...	1.25	0.6	1.50	2.50	1.00	2.30		
	3IR1.50-D76SH-1.15...	1.50	0.8	1.85	3.00	1.15	2.10		
	3IR1.75-D76SH-1.30...	1.75	1.0	2.20	3.50	1.30	1.90		

Profilangebot auch auf IC 1/4", 1/2" und 5/8" erhältlich, Platten auf Anfrage.
Für minimalen Bohrungsdurchmesser bitte Seite 165 beachten.

DIN 3770 - Stechen



Innen

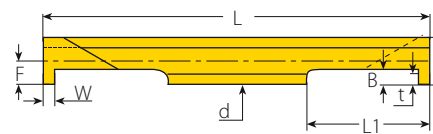
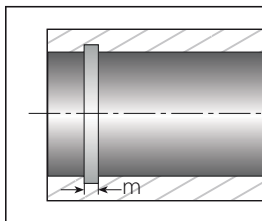

RH - Zweiseitig

Micro - Zweiseitig

Einsatzdurchmesser	Bestellnummer	Norm	Abmessungen mm						Min. Bohrungsdurchmesser	Halter
d [mm]	RH	m (H13)	W	L1	L	B	t	F	mm	
6.0	6.0SIR1.6S-D3770S-1.5...	1.6	1.98	9.0	36.0	1.8	1.5	2.9	6.1	SMC...-6.0
	6.0SIR1.6M-D3770S-1.5...	1.6	1.98	16.0	50.0					
	6.0SIR1.6L-D3770S-1.5...	1.6	1.98	21.0	60.0					
	6.0SIR2.0S-D3770D-1.8...	2.0	2.38	9.0	36.0	2.0	1.8	2.9		
	6.0SIR2.0M-D3770D-1.8...	2.0	2.38	16.0	50.0					
	6.0SIR2.0L-D3770D-1.8...	2.0	2.38	21.0	60.0					

DIN 471 DIN 472 - Axial- Stechen



Innen

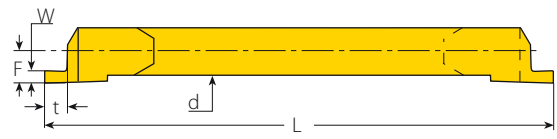
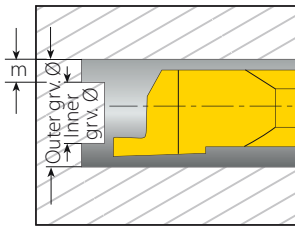

RH - Zweiseitig

Micro (Teilprofil) - Zweiseitig

Einsatzdurchmesser	Bestellnummer	Norm	Abmessungen mm				Innen Nut Ø	Aussen Nut Ø	
d [mm]	RH	m (H13)	W	t	L	F	Hülse		
4.0	4.0SIR0.7A-D471/472-1.4...	0.70	0.77	1.4	50	1.40	SMC...-4.0	3.50	5.00
	4.0SIR0.8A-D471/472-1.5...	0.80	0.87	1.5				3.40	5.20
	4.0SIR0.9A-D471/472-1.6...	0.90	0.97	1.6				3.30	5.30
	4.0SIR1.1A-D471/472-1.8...	1.10	1.19	1.8				3.10	5.50
	4.0SIR1.3A-D471/472-2.0...	1.30	1.39	2.0				2.90	5.70
	4.0SIR1.6A-D471/472-2.3...	1.60	1.69	2.3				2.60	6.00
6.0	6.0SIR0.7A-D471/472-1.4...	0.70	0.77	1.4	50	1.90	SMC...-6.0	5.50	7.00
	6.0SIR0.8A-D471/472-1.5...	0.80	0.87	1.5				5.40	7.20
	6.0SIR0.9A-D471/472-1.6...	0.90	0.97	1.6				5.30	7.30
	6.0SIR1.1A-D471/472-1.8...	1.10	1.19	1.8				5.10	7.50
	6.0SIR1.3A-D471/472-2.0...	1.30	1.39	2.0				4.90	7.70
	6.0SIR1.6A-D471/472-2.3...	1.60	1.69	2.3				4.60	8.00
	6.0SIR1.85A-D471/472-2.5...	1.85	1.94	2.5				4.40	8.20
	6.0SIR2.15A-D471/472-2.8...	2.15	2.24	2.8				4.10	8.50
8.0	8.0SIR1.1A-D471/472-1.8...	1.10	1.19	1.8	70	3.95	SMC...-8.0	8.06	10.44
	8.0SIR1.3A-D471/472-2.0...	1.30	1.39	2.0				7.66	10.44
	8.0SIR1.6A-D471/472-2.3...	1.60	1.69	2.3				7.06	10.44
	8.0SIR1.85A-D471/472-2.5...	1.85	1.94	2.5				6.56	10.44
	8.0SIR2.15A-D471/472-2.8...	2.15	2.24	2.8				5.96	10.44
	8.0SIR2.65A-D471/472-3.3...	2.65	2.74	3.3				4.96	10.44
10.0	10.0SIR1.3A-D471/472-2.0...	1.30	1.39	2.0	80	4.95	SMC...-10.0	9.66	12.44
	10.0SIR1.6A-D471/472-2.3...	1.60	1.69	2.3				9.06	12.44
	10.0SIR1.85A-D471/472-2.5...	1.85	1.94	2.5				8.56	12.44
	10.0SIR2.15A-D471/472-2.8...	2.15	2.24	2.8				7.96	12.44
	10.0SIR2.65A-D471/472-3.3...	2.65	2.74	3.3				6.96	12.44
	10.0SIR3.15A-D471/472-3.8...	3.15	3.24	3.8				5.96	12.44
	10.0SIR4.15A-D471/472-4.8...	4.15	4.24	4.8				3.96	12.44

Einstechplatten

Einstechen



Innen

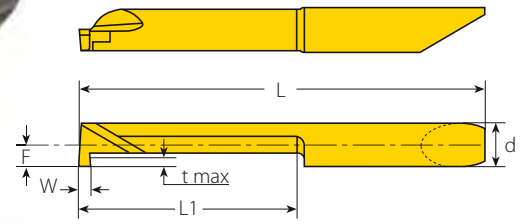
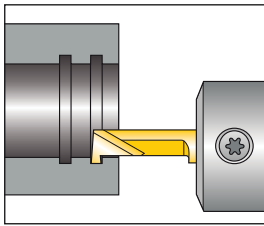

RH - Einseitig

Micro - Einseitig



Abmessung des Einstichs (mm)		Einsatzdurchmesser	Bestellnummer	Abmessungen mm			Min. Bohrungsdurchmesser	Halter
W± 0.025	t max	d [mm]	RH/LH	L1	L	F	mm	
1.0	0.8	4.0	M442GS W100 L10R/L	10	35	2.0	4.2	MHC...-4
			M442GS W100 L15R/L	15	41			
			M442GS W100 L20R/L	20	46			
1.0	1.0	5.0	M552GS W100 L10R/L	10	35	2.5	5.2	MHC...-5
			M552GS W100 L15R/L	15	41			
M552GS W100 L20R/L			20	46				
1.5			M552GS W150 L10R/L	10	35			
			M552GS W150 L15R/L	15	41			
2.0			M552GS W150 L20R/L	20	46			
	M552GS W200 L10R/L	10	35					
1.0	1.8	6.0	M662GS W100 L10R/L	10	36	3.0	6.2	MHC...-6
			M662GS W100 L15R/L	15	42			
M662GS W100 L20R/L			20	47				
1.5			M662GS W100 L30R/L	30	56			
			M662GS W150 L10R/L	10	36			
2.0			M662GS W150 L15R/L	15	42			
	M662GS W150 L20R/L	20	47					
	M662GS W150 L30R/L	30	56					
	M662GS W200 L10R/L	10	36					
1.0	2.5	7.0	M772GS W100 L10R/L	10	36	3.5	7.2	MHC...-7
			M772GS W100 L15R/L	15	41			
M772GS W100 L25R/L			25	51				
1.5			M772GS W100 L35R/L	35	61			
			M772GS W150 L10R/L	10	36			
2.0			M772GS W150 L15R/L	15	41			
	M772GS W150 L25R/L	25	51					
	M772GS W150 L35R/L	35	61					
	M772GS W200 L10R/L	10	36					
			M772GS W200 L15R/L	15	41			
			M772GS W200 L25R/L	25	51			
			M772GS W200 L35R/L	35	61			
			M772GS W200 L35R/L	35	61			

Microscope LH Werkzeug lieferbar auf Anfrage (Beispiel: M442GS W100L10L...)

Einstecken, Rund



Innen

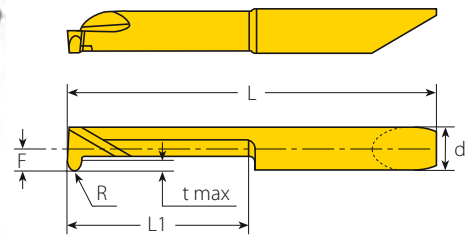
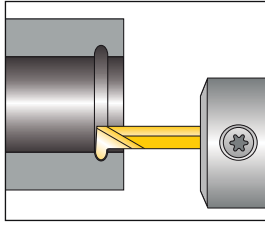

RH - Einseitig

Micro - Einseitig

microscope

Abmessung des Einstichs (mm)		Einsatzdurchmesser	Bestellnummer	Abmessungen (mm)				Min. Bohrungsdurchmesser	Halter		
W±0.025	t max			d [mm]	RH/LH	R	L1			L	F
1.0	0.8	4.0	M442GR R050 L15R/L	0.5	15	39	1.95	4.2	MHC ..-4		
1.0	1.0		M552GR R050 L20R/L	0.5						46	
1.5		6.0	M552GR R075 L20R/L	0.75	20	46	2.45			5.2	MHC ..-5
2.0			M552GR R100 L20R/L	1.0	46						
1.0	1.8	5.0	M662GR R050 L25R/L	0.5	25	52	2.95	6.2	MHC ..-6		
1.5			M662GR R075 L25R/L	0.75						52	
2.0			M662GR R100 L25R/L	1.0						52	

Microscope LH Werkzeug lieferbar auf Anfrage (Beispiel: M442GR R050L15L...)

Axial einstecken, innen



Micro - Einseitig

microscope

Abmessung des Einstichs (mm)		Einsatzdurchmesser	Bestellnummer	Abmessungen mm				Min. Bohrungsdurchmesser	Halter
W±0.025	t max	d [mm]	RH/LH	R	L1	L	F	mm	
1.0	2	6.0	M662FG W10 L15R/L	0.1	15	42	2.95	6.2	MHC ..-6
1.5	3		M662FG W15 L15R/L						
2.0	4		M662FG W20 L15R/L						
2.5	5		M662FG W25 L15R/L						
3.0	6		M662FG W30 L15R/L						

Einstechplatten

Axial einstecken, aussen



Micro - Einseitig

microscope

Abmessung des Einstichs (mm)		Einsatzdurchmesser	Bestellnummer	Abmessungen mm				Min. Bohrungsdurchmesser.	Halter
W±0.025	t max	d [mm]	RH/LH	R	L1	L	F	mm	
1.0	2	6.0	M662FP W10 L15R/L	0.1	15	42	2.95	6.2	MHC ..-6
1.5	3		M662FP W15 L15R/L						
2.0	4		M662FP W20 L15R/L						
2.5	5		M662FP W25 L15R/L						
3.0	6		M662FP W30 L15R/L						

Vorstechen



Micro - Einseitig



Abmessung des Einstichs (mm)		Einsatzdurchmesser	Bestellnummer	Abmessungen (mm)			Min. Bohrungsdurchmesser		
W±0.025	t max	d [mm]	RH/LH	t	L1	L	F	mm	Halter
1.0	0.7	5.0	M552PP W100 L15R/L	0.3	15	41	2.45	5.2	MHC...-5
			M552PP W100 L20R/L		20	46			
			M552PP W100 L25R/L		25	51			
			M552PP W100 L30R/L		30	55			

Microscope LH Werkzeug lieferbar auf Anfrage (Beispiel: M662FP W10 L15L...)



Einstecken



> Klemmhalter

Stechhalter

- Aussenbearbeitung Standard Seite 164
- Innenbearbeitung Standard Seite 165
- Innenbearbeitung Mini-L Seite 166
- Innenbearbeitung Mini-L, verstellbar Seite 166
- Micro Seite 167
- Microscope Seite 168





VARDEX Bestellnummernsystem siehe Seite 99.



Klemmhalter für die Aussenbearbeitung

Einstechen Klemmhalter

Standard

Standard						Ersatzteile				
Plattengröße	Bestellnummer	Abmessungen mm								*
IC	RH	H=H1=B	F	L1	L2	Klemmschraube	Schraube f. U-Platte	Torx Schlüssel	Unterlegplatte RH	
1/4"	NL8-2	8	11	136.4	17.5	SN2T	-	K2T	-	
	NL10-2	10	11	70.0	17.5					
	NL12-2	12	12	80.0	17.5					
3/8"	AL3/8-3	9.52	16	63.6	20.5	SA3T	SY3T	K3T	YE3M-1.5N	
	AL12-3	12	16	100.0	22.0					
	AL16-3	16	16	83.2	20.5					
	AL20-3	20	20	128.6	30.0					
	AL25-3	25	25	153.6	30.0					
1/2"	AL25-4	25	25	155.7	36.0	SA4T	SY4T	K4T	YE4M-1.5N	
	AL32-4	32	32	175.7	36.0					
	AL40-4	40	40	205.7	36.0					
5/8"	AL25-5	25	32	151.6	35.0	SA5T	SY5T	K5T	YE5M-1.5N	
	AL32-5	32	32	176.6	40.0					
	AL40-5	40	40	206.6	40.0					
	AL50-5	50	50	256.6	40.0					



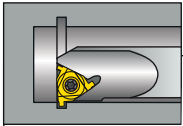

* Die Stechhalter werden mit Standardunterlegplatten geliefert. Zum Stechen verwenden Sie bitte die in der Tabelle angegebenen Unterlegplatten.

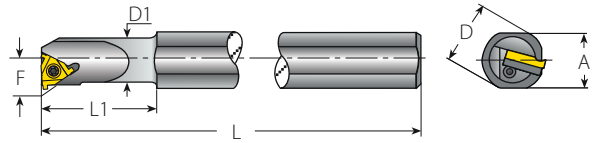

Klemmhalter für die Innenbearbeitung



Standard

Plattengröße		Bestellnummer	Abmessungen mm					Min. Bohrungsdurchmesser	Ersatzteile				
IC	RH	A	L	L1	D	D1	F	mm					*
1/4"	NVR10D-2	100	180	25	20	10.0	7.3	13					
	NVR10-2	18.0	180	25	20	10.0	7.3	13	SN2T	-	K2T	-	
	NVR13-2	18.0	180	32	20	13.0	8.9	16					
3/8"	NVR13-3	18.0	180	32	20	12.7	10.3	17					
	NVR16-3	18.0	180	40	20	16.0	11.5	20	SN3T	-	K3T	-	
	NVR16D-3	15.2	150	32	16	16.0	11.3	20					
	AVR20-3	18.0	180	40	20	20.0	13.4	24					
	AVR25-3	29.0	250	60	32	25.0	16.3	29					
	AVR25D-3	22.6	200	45	25	24.6	16.1	29	SA3T	SY3T	K3T	YI3M-1.5N	
	AVR32-3	29.0	250	60	32	32.0	19.6	36					
1/2"	AVR40-3	36.0	300	60	40	40.0	23.8	44					
	NVR20-4	18.0	180	50	20	20.0	15.6	27	SN4T	-	K4T	-	
	AVR25-4	29.0	250	60	32	25.0	17.4	32					
	AVR25D-4	22.6	200	45	25	24.6	17.2	32	SA4T	SY4T	K4T	YI4M-1.5N	
	AVR32-4	29.0	250	60	32	32.0	21.5	39					
5/8"	AVR40-4	36.0	300	60	40	40.0	25.8	47					
	AVR32-5	29.0	250	60	32	32.0	22.4	40	SN5T	SY5T	K5T	YI5M-1.5N	
	AVR40-5	36.0	300	60	40	40.0	26.4	48					
	AVR50-5	45.0	350	75	50	50.0	31.4	58	SA5T	SY5T	K5T	YI5M-1.5N	
	AVR60-5	54.0	400	75	60	60.0	36.4	69					

* Die Stechhalter werden mit Standardunterlegplatten geliefert. Zum Stechen verwenden Sie bitte die in der Tabelle angegebenen Unterlegplatten. Halter mit Kühlkanal sind als Standard erhältlich Bestellnummer siehe bitte Seite 99.

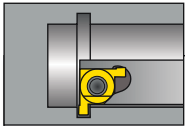

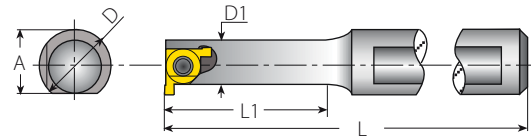

Klemmhalter für die Innenbearbeitung



Mini-L

Ersatzteile

Plattengröße	Bestellnummer	Abmessungen mm					Dämpfungssystem		
IC	RH	A	L	L1	D	D1			
5.0L	SNVR 10U-5L	9.4	81	16	10	6.2	ohne	SN5LT	K5LT
	BNVR 10S-5L	9.4	87	22	10	6.2	mit Hartmetallkern		
	BNVR 10M-5L	9.4	97	31	10	6.2	mit Hartmetallkern		
	BNVR 10L-5L	9.4	109	43	10	6.2	mit Hartmetallkern		



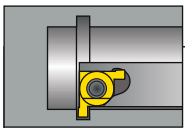

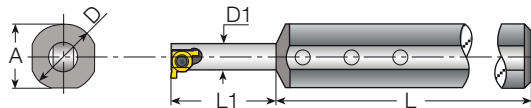
Einstechen Klemmhalter





Mini-L – Halter verstellbar

Ersatzteile

Plattengröße	Bestellnummer		Abmessungen mm								
IC	Hülse	Halter RH	A	L	L1	D	D1	Klemmschraube	Torx-Schlüssel für Klemmschraube	Feststellschraube x 3	Schlüssel für Feststellschraube
5.0L	SV16-6.2	BNVR6.2T-5L	15.6	100	8-44	16	6.2	SN5LT	K5LT	S4.0	K2.0

Klemmhalter für die Innenbearbeitung



Micro - Zweiseitig

Ersatzteile



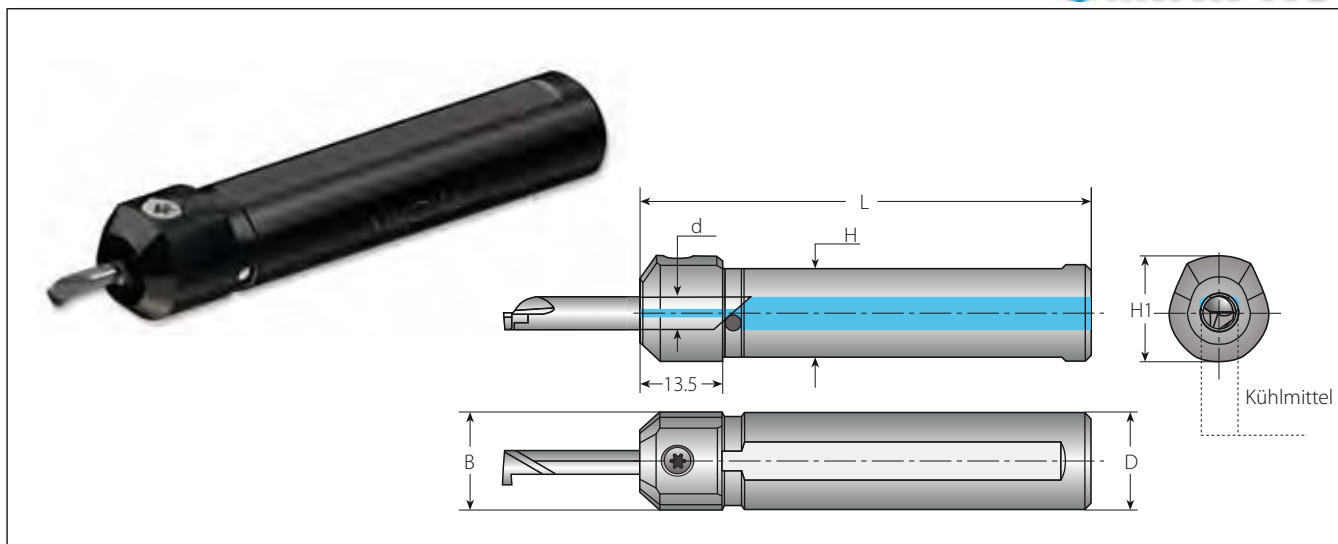

Micro-Einsatz Ø	Schaft durchmesser	Bestellnummer	Abmessungen mm			Justierschraube*			Befestigungsschraube x 3					
			d (mm)	D	L	L1	L0	Schraube	M	Schlüssel	Schraube	Schlüssel		
3	10	SMC10-3.0	80	9- Kurz	89	4GISM8X28	28	K4.0	M4X0.7X4.0	K2.0				
	12	SMC12-3.0		16- Mittel	96	4GISM8X21	21							
	16	SMC16-3.0	95	9- Kurz	104	4GISM8X49	49							
	20	SMC20-3.0		16- Mittel	111	4GISM8X42	42							
4	10	SMC10-4.0	80	9- Kurz	89	4GISM8X28	28				K4.0	M4X0.7X4.0	K2.0	
	12	SMC12-4.0		16- Mittel	96	4GISM8X21	21							
	16	SMC16-4.0	95	9- Kurz	104	4GISM8X49	49							
	20	SMC20-4.0		16- Mittel	111	4GISM8X42	42							
6	10	SMC10-6.0	80	9- Kurz	89	4GISM8X28	28		K4.0	M4X0.7X4.0				K2.0
	12	SMC12-6.0		16- Mittel	96	4GISM8X21	21							
	16	SMC16-6.0	95	9- Kurz	104	4GISM8X49	49							
	20	SMC20-6.0		16- Mittel	111	4GISM8X42	42							
8	12	SMC12-8.0	80	9- Kurz	89	4GISM8X28	28	K4.0				M4X0.7X4.0	K2.0	
	16	SMC16-8.0		16- Mittel	96	4GISM8X21	21							
	20	SMC20-8.0	95	21- Lang	101	4GISM8X16	16							
	16	SMC16-8.0		9- Kurz	104	4GISM8X49	49							
10	16	SMC16-10.0	95	16- Mittel	111	4GISM8X42	42			K4.0	M6X1.0X5.0			K3.0
	20	SMC20-10.0		21- Lang	116	4GISM8X37	37							
	12	SMC12-10.0	95	12- Kurz	107	4GISM8X33	33							
	20	SMC20-10.0		20- Mittel	115	4GISM8X25	25							
10	16	SMC16-10.0	95	28- Lang	123	4GISM8X17	17		K4.0			M6X1.0X5.0	K3.0	
	20	SMC20-10.0		15- Kurz	110	4GISM8X30	30							
	16	SMC16-10.0	95	25- Mittel	120	4GISM8X20	20							
	20	SMC20-10.0		35- Lang	130	4GISM8X10	10							

Jeder Klemmhalter Set enthält alle benötigten Justierschrauben



Micro - Einseitig

Ersatzteile **microscope**

Micro Einsatzdurchmesser	Bestellnummer	Abmessungen mm					
d (mm)		D=B	H1	H	L	Befestigungsschraube	Schlüssel
4.0	MHC 10-4	10	14	8.8	65	SL7DT15	KT15
	MHC 12-4	12	16	10.8	70		
	MHC 16-4	16	17.6	14.8	75		
	MHC 20-4	20	22	18.8	84		
5.0	MHC 10-5	10	14	8.8	65		
	MHC 12-5	12	16	10.8	70		
	MHC 16-5	16	18.6	14.8	75		
	MHC 20-5	20	22	18.8	84		
6.0	MHC 12-6	12	16	10.8	70		
	MHC 16-6	16	18.6	14.8	75		
	MHC 20-6	20	22	18.8	84		
7.0	MHC 16-7	16	18.6	14.8	75		
	MHC 20-7	20	22	18.8	84		

Einstechen Klemmhalter

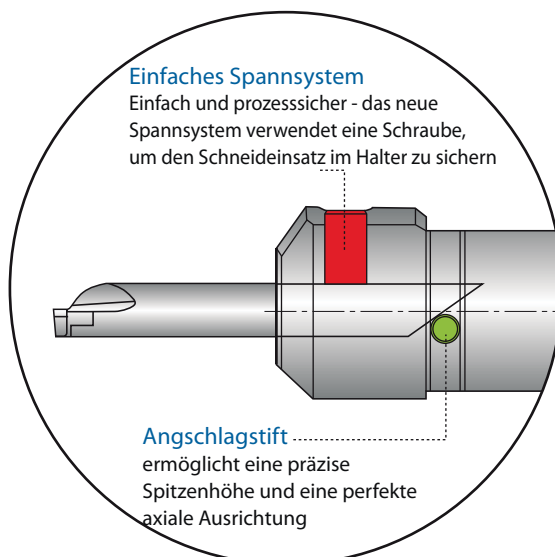



Einstecken

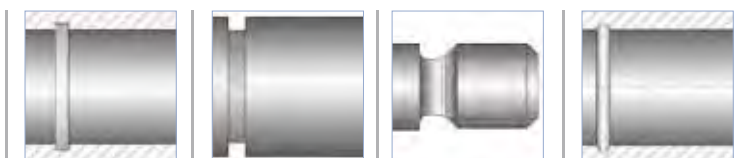

> Technische Daten

Empfohlene Sorten, Schnittgeschwindigkeiten Vc [m/min] und Vorschub Vf [mm/U]

Materialgruppe	VarDEX Nr.	Material	Härte Brinell HB	Vc [m/min]				Vorschub [mm/U]		
				Beschichtete				Standard & Mini	Micro & Microscope	
				VTX (Standard)	VMX/VBX (Micro & Microscope)	VKP (Mini)	VHX (Mini)			
P Stahl	1	Unlegierter Stahl	Geringer Kohlenstoffanteil (C=0.1-0.25%)	125	140-200	50-120	140-200	20-50	0.3	0.03
	2		Mittlerer Kohlenstoffanteil (C= 0.25- 0.55%)	150	120-180	40-100	120-180	15-40	0.15	0.02
	3		Hoher Kohlenstoffanteil (C= 0.55- 0.85%)	170	110-180	30-80	110-180	15-30	0.05	0.01
	4	Niedriglegierter Stahl (Legierungs- Elemente ≤ 5%)	Ungehärtet	180	100-155	50-70	100-155	20-45	0.25	0.02
	5		Gehärtet	275	90-145	40-60	90-145	10-25	0.1	0.01
	6		Gehärtet	350	80-135	30-50	80-135	10-25	0.05	0.01
	7	Hochlegierter Stahl (Legierungs- Elemente >5%)	Vergütet	200	70-115	30-50	65-115		0.2	0.02
	8		Gehärtet	325	50-100	25-40	50-100		0.05	0.01
	9	Stahlguss	Niedriglegiert (Legierungs- Elemente ≤ 5%)	200	30-50	30-50	30-50	25-50	0.2	0.02
	10		Hochlegiert (Legierungs- Elemente > 5%)	225	20-40	25-40	25-40	20-40	0.05	0.02
M Edelstahl	11	Edelstahl Ferritisch	Ungehärtet	200	70-120	60-100	80-120		0.2	0.01
	12		Gehärtet	330	60-95	40-60	55-95		0.05	0.01
	13	Edelstahl Austenitisch	Austenitisch	180	70-100	50-90	60-100		0.2	0.01
	14		Super- Austenitisch	200	40-90	40-60	50-90		0.05	0.01
	15	Edelstahlguß Ferritisch	Ungehärtet	200	80-110	40-60	60-80		0.2	0.02
	16		Gehärtet	330	65-110	30-50	45-65		0.05	0.01
	17	Guss austenitisch	Austenitisch	200	85-100	40-60	50-70		0.2	0.02
	18		Gehärtet	330	60-100	30-50	40-60		0.05	0.01
K Gußeisen	28	Temperguss	Ferritisch (kurzspanig)	130	70-120	50-70	60-80		0.2	0.02
	29		Perlitisch (langspanig)	230	70-120	50-70	60-80		0.15	0.01
	30	Grauguss	Niedrigfest	180	70-120	50-70	60-80		0.2	0.02
	31		Hochfest	260	60-100	40-60	40-70		0.1	0.15
	32	Kugelgraphitguss	Ferritisch	160	50-80	50-70	60-80		0.2	0.02
33	Perlitisch		260	60-90	60-80	70-90		0.1	0.01	
N_(K) Nichteisen- Metalle	34	Aluminium- Legierungen, schmiedeeisern	ungealtert	60	100-240	100-300	80-240	30-60	0.4	0.03
	35		gealtert	100	80-170	100-150	100-170	25-50	0.1	0.03
	36	Aluminium- Legierungen	Guß	75	100-150	100-150	100-150	25-50	0.25	0.03
	37		Guß & gealtert	90	80-120	60-100	60-100	20-40	0.15	0.03
	38	Aluminium- Legierungen	Guß Si 13- 22%	130	100-150	100-150	100-150	15-30	0.15	0.02
	39	Kupfer und Kupferlegierungen	Messing	90	80-200	60-100	80-200	15-35	0.2	0.03
	40		Bronze und bleifreies Kupfer	100	80-200	60-100	80-200	15-35	0.15	0.03
S_(M) Hitzebe- ständige Material	19	Hochtemperaturle- gierungen	Vergütet (Eisen basiert)	200	45-60	25-45	25-45		0.2	0.01
	20		Gealtert (Eisen basiert)	280	35-50	20-30	20-30		0.05	0.01
	21		Vergütet (Nickel oder Cobalt basiert)	250	20-30	15-20	15-20		0.05	0.01
	22		Gealtert (Nickel oder Cobalt basiert)	350	15-25	10-15	10-15		0.05	0.01
	23	Titanlegierungen	Reines 99,5 Ti	400Rm	140-170	60-100	60-100		0.1	0.02
	24		α+β Legierungen	1050Rm	50-70	40-50	40-50		0.05	0.02
H_(K) Gehärtetes Material	25	Extra harter Stahl	Gehärtet & angelassen	45-50HRc	45-60	20-40	20-40		0.02	0.01
	26			51-55HRc	40-50	20-35	20-35		0.02	0.01

Sorten und ihre Anwendungen

Sorte	Anwendung	Beispiel	Sorte	Anwendung	Beispiel
VTX	Erste Wahl für alle Anwendungen. Eine zähe Feinkorn Hartmetallsorte mit TiAlN- Beschichtung. Bietet gute Bruch- und hervorragende Verschleissfestigkeit.		VKP	Allround- Hartmetallsorte für Mini- L- Platten. TiN - farbige PVD-Beschichtung. 	
VMX	Allround- Sorte für Micro- Platten. TiN - farbige PVD-Beschichtung. 		VHX	Allround HSS-Sorte, für Mini-Platten. TiN - farbige PVD-Beschichtung, für niedrige Schnittgeschwindigkeiten. 	
VBX	Erste Wahl für alle Anwendungen für Microscope Platten. TiCN- Beschichtung. 				



Ausdrehen



Wendeplatten & Einsätze für die Innenbearbeitung

■ Vardex Bestellnummernsystem.....	Seite 173
■ CD0W- Wendeplatten.....	Seite 174
■ TD0W- Wendeplatten.....	Seite 174
■ WC0W- Wendeplatten.....	Seite 175
■ Boring - Micro (Ausdrehen).....	Seite 176
■ Boring - Microscope (Ausdrehen).....	Seite 177
■ Copy - Micro (Kopierdrehen).....	Seite 178
■ Chamfer - Micro (Fasen).....	Seite 178
■ Long Nose - Micro (Kopierdrehen für tieferes Hinterdrehen).....	Seite 179
■ Long Nose - Microscope (Kopierdrehen für tieferes Hinterdrehen).....	Seite 179
■ Back Edge - Micro (rückwärts Plandrehen).....	Seite 180
■ Boredrill - Micro (Bohrdrehen ins Volle).....	Seite 180

Vardex Bestellnummernsystem

PowerBore- Wendepplatten

T	D	0	W	41	14	VTX
1	2	3	4	5	6	7
1 - Plattenform	2 - Freiwinkel	3 - Toleranzklasse		4 - Platte		
C - Raute 80° T - Dreieck W - Trigon 80°	C - 7° D - 15°	0 - Spezielle Toleranzklasse		W - Bohrung + Ansenkung		
5 - Plattenabmessung	6 - Schneidenradius	7 - Hartmetallsorte				
40-IC 0.156" - Dicke-1.02mm 41-IC 0.160" - Dicke-1.19mm 42-IC 0.156" - Dicke-1.57mm 50-IC 0.187" - Dicke-2.44mm	11- R 0.05 12- R 0.18 13- R 0.20 14- R 0.38	VTX				

MicroBoring- Einsätze - Zweiseitig

6.0	S	I	R	0.2	M	-	Bore	-	1	VMX
1	2	3	4	5	6		7		8	9
1 - Einsatz Ø	2 - Werkzeuggruppe		3 - Platte		4 - RH oder LH		5 - Schneidenradius			
3.0 4.0 6.0 8.0 10.0	S - Vollhartmetall		I - Innen		R - Rechte Platte R - Linke Platte		0.2			
6 - Werkzeuglänge	7 - Werkzeugawendung				8 - Frontschliff		9 - Hartmetallsorte			
U - Ultra kurz S - kurz M - mittel L - lang	Bore - Ausdrehen Copy - Kopierdrehen Chamfer - Fasen Back - rückwärts Plandrehen 3527, 3537, 3547 - für tieferes Kopierdrehen BD - Bohr- Drehen ins Volle				1 - mit Freiwinkel 0 - ohne Freiwinkel		VMX			

microscope Wendepplatten - Einseitig

M	4	17	BC	R	10	L09	R	VBX	
1	2	3	4	5	6	7	8	9	
1 - Produktlinie	2 - Plattengröße		3 - Min Bohrungsdurchmesser			4 - Anwendung		5 - 6 Radius an Schneidecke	
M - Microscope	4, 5, 6, 7		1.7 - 7.2			BC - Ausdrehen CL - für tieferes Kopierdrehen		0.1, 0.15, 0.2 (mm)	
7 - Auskraglänge	8 - RH oder LH		9 - Hartmetallsorte						
L09 - L50	R - RH L - LH		VBX						

Technische Daten



Innen

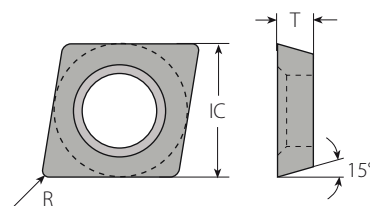
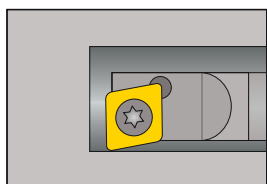

CD0W

CD0W- Wendeplatten



Plattengröße	Bestellnummer	Abmessungen (mm)		Klemmschraube 
		R	T	
.156"	CD0W4011...	0.05	1.02	VS01
	CD0W4012...	0.18	1.02	
	CD0W4014...	0.38	1.02	

Innen

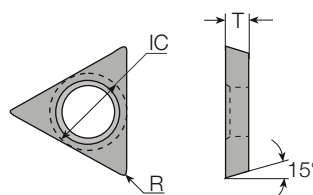
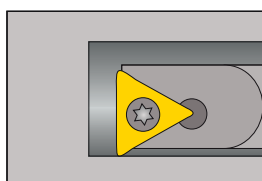

TD0W

TD0W- Wendeplatten



Plattengröße	Bestellnummer	Abmessungen (mm)		Klemmschraube 
		R	T	
.160"	TD0W4111...	0.05	1.19	VS01, VS40
	TD0W4112...	0.18	1.19	
	TD0W4114...	0.38	1.19	

Wendeplatten & Einsätze für die Innenbearbeitung

Technische Daten



Innen

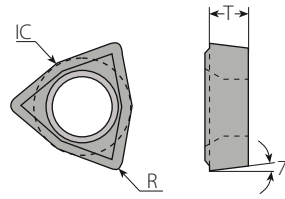
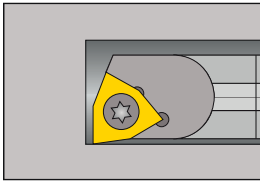

WCOW 4213, 4214

WCOW- Wendeplatten



Plattengröße	Bestellnummer	Abmessungen (mm)		Klemmschraube 
IC		R	T	
.156"	WCOW4213...	0.20	1.57	VS40
	WCOW4214...	0.38	1.57	

Innen

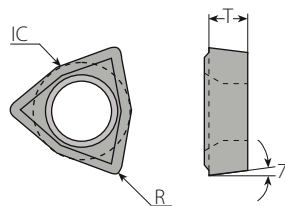
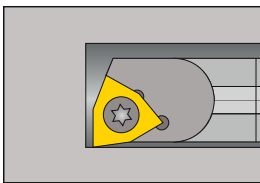

TDOW

WCOW- Wendeplatten



Plattengröße	Bestellnummer	Abmessungen (mm)		Klemmschraube 
IC		R	T	
.187"	WCOW5013...	0.20	2.44	VS41
	WCOW5014...	0.38	2.44	

Wendeplatten & Einsätze für die Innenbearbeitung

Micro Boring (Ausdrehen)



Innen

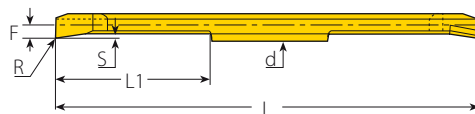
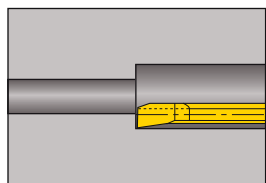

RH - Zweiseitig

Micro - Zweiseitig

Einsatzdurchmesser	Bestellnummer	Abmessungen mm					Min. Bohrungsdurchmesser	Halter
d [mm]	RH	R	L1	L	S	F	mm	
3.0	3.0SIR0.1U-Bore-1...	0.1	6	36	0.40	0.22	2.0	SMC...-3.0
	3.0SIR0.1S-Bore-1...	0.1	9	36	0.40	0.22		
	3.0SIR0.2S-Bore-1...	0.2	9	36	0.66	1.42	3.2	
	3.0SIR0.2M-Bore-1...	0.2	16	50	0.66	1.42		
4.0	4.0SIR0.2S-Bore-1...	0.2	9	36	0.66	1.92	4.2	SMC...-4.0
	4.0SIR0.2M-Bore-1...	0.2	16	50	0.66	1.92		
	4.0SIR0.2L-Bore-1...	0.2	21	60	0.66	1.92		
6.0	6.0SIR0.2S-Bore-1...	0.2	9	36	0.77	2.92	6.2	SMC...-6.0
	6.0SIR0.2M-Bore-1...	0.2	16	50	0.77	2.92		
	6.0SIR0.2L-Bore-1...	0.2	21	60	0.77	2.92		
8.0	8.0SIR0.2S-Bore-1...	0.2	12	54	0.82	3.92	8.2	SMC...-8.0
	8.0SIR0.2M-Bore-1...	0.2	20	70	0.82	3.92		
	8.0SIR0.2L-Bore-1...	0.2	28	86	0.82	3.92		
10.0	10.0SIR0.2S-Bore-1...	0.2	15	60	1.00	4.92	10.2	SMC...-10.0
	10.0SIR0.2M-Bore-1...	0.2	25	80	1.00	4.92		
	10.0SIR0.2L-Bore-1...	0.2	35	100	1.00	4.92		

Wendeplatten & Einsätze für die Innenbearbeitung

Micro Boring (Ausdrehen)

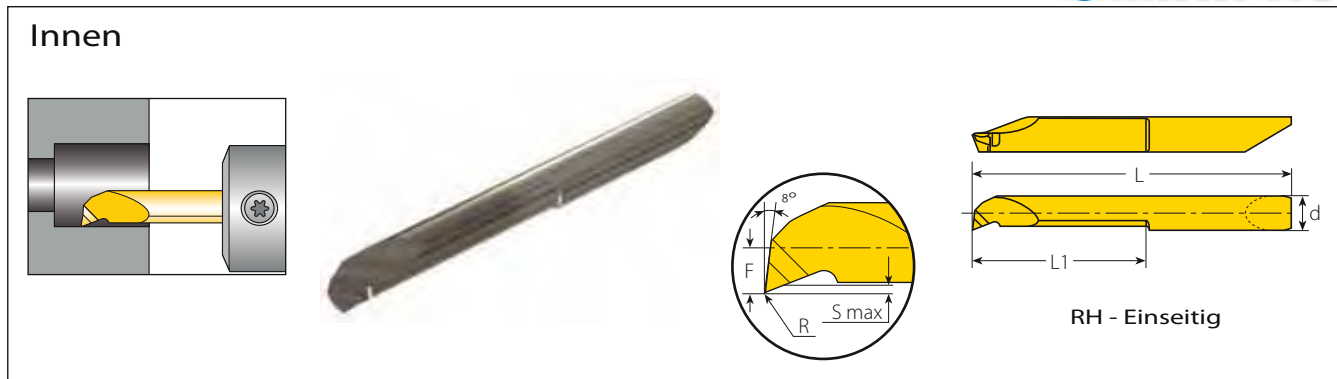

Micro - Einseitig



Einsatzdurchmesser	Bestellnummer	Abmessungen mm					Min. Bohrungsdurchmesser	Halter
d [mm]	RH/LH	R	L1	L	S max	F	mm	
4.0	M410BC R10 L06R/L	0.1	6	24	0.15	0.47	1.0	
	M415BC R10 L09R/L		9	27		0.76	1.5	
	M417BC R10 L09R/L		9	28		0.7	1.7	
	M422BC R10 L09R/L	0.1	9	28	0.15	0.95	2.2	
	M422BC R10 L14R/L		14	33				
	M432BC R15 L10R/L	0.15	10	28	0.15	1.45	3.2	
	M432BC R15 L16R/L		16	33				
	M432BC R15 L20R/L		20	39				
	M442BC R15 L10R/L	0.15	10	28	0.3	1.95	4.2	
	M442BC R15 L16R/L		16	33				
M442BC R15 L21R/L	21		39					
M442BC R15 L26R/L	26		45					
5.0	M552BC R20 L10R/L	0.2	10	35	0.5	2.45	5.2	
	M552BC R20 L16R/L		16	41				
	M552BC R20 L21R/L		21	46				
	M552BC R20 L26R/L		26	51				
	M552BC R20 L30R/L		30	55				
	M552BC R20 L35R/L		35	60				
6.0	M662BC R20 L16R/L	0.2	16	42	0.5	2.95	6.2	
	M662BC R20 L21R/L		21	47				
	M662BC R20 L26R/L		26	52				
	M662BC R20 L30R/L		30	56				
	M662BC R20 L35R/L		35	61				
	M662BC R20 L40R/L		40	66				
7.0	M772BC R20 L25R/L	0.2	25	51	0.5	3.45	7.2	
	M772BC R20 L35R/L		35	61				
	M772BC R20 L40R/L		40	66				
	M772BC R20 L45R/L		45	71				
	M772BC R20 L50R/L		50	76				

Microscope LH Werkzeug lieferbar auf Anfrage (Beispiel: M417BC R10L09L...)

Wendeleitungen & Einätze für die Innenbearbeitung

Micro Kopierdrehen



Innen

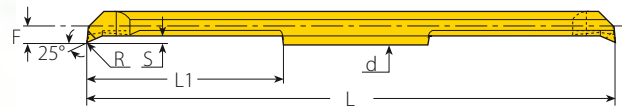
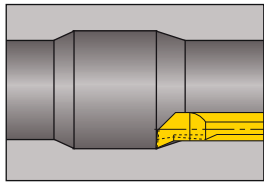

RH - Zweiseitig

Micro - Zweiseitig

Einsatzdurchmesser	Bestellnummer	Abmessungen mm					Min. Bohrungsdurchmesser	Halter
d (mm)	RH	R	L1	L	S	F	mm	
4.0	4.0SIR0.2S-Copy-1...	0.2	9	36	1.0	1.92	4.2	SMC...-4.0
	4.0SIR0.2M-Copy-1...	0.2	16	50	1.0	1.92		
	4.0SIR0.2L-Copy-1...	0.2	21	60	1.0	1.92		
6.0	6.0SIR0.2S-Copy-1...	0.2	9	36	1.3	2.92	7.0	SMC...-6.0
	6.0SIR0.2M-Copy-1...	0.2	16	50	1.3	2.92		
	6.0SIR0.2L-Copy-1...	0.2	21	60	1.3	2.92		

Micro Fasen

Innen

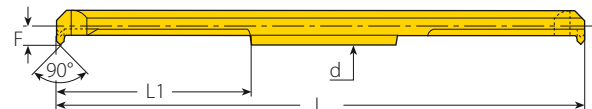
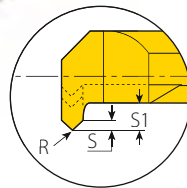
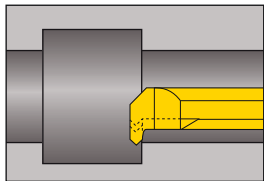

RH - Zweiseitig

Micro - Zweiseitig

Einsatzdurchmesser	Bestellnummer	Abmessungen mm						Min. Bohrungsdurchmesser	Halter
d [mm]	RH	R	L1	L	F	S1	S	mm	
4.0	4.0SIR0.2S-Chamfer-0...	0.2	9	36	1.92	1.0	0.40	4.2	SMC...-4.0
	4.0SIR0.2M-Chamfer-0...	0.2	16	50	1.92	1.0	0.40		
	4.0SIR0.2L-Chamfer-0...	0.2	21	60	1.92	1.0	0.40		
6.0	6.0SIR0.2S-Chamfer-0...	0.2	9	36	2.92	1.2	0.70	6.2	SMC...-6.0
	6.0SIR0.2M-Chamfer-0...	0.2	16	50	2.92	1.2	0.70		
	6.0SIR0.2L-Chamfer-0...	0.2	21	60	2.92	1.2	0.70		

Micro Kopierdrehen - für tieferes Hinterdrehen



Innen

RH - Zweiseitig

Micro - Zweiseitig

Einsatzdurchmesser	Bestellnummer	Abmessungen mm					Min. Bohrungsdurchmesser	Halter
d [mm]	RH	R	L1	L	F	S	mm	
6.0	6.0SIR0.2S-3527-1...	0.2	9	36	2.7	2.92	6.9	SMC...-6.0
	6.0SIR0.2M-3527-1...	0.2	16	50	2.7	2.92		
	6.0SIR0.2L-3527-1...	0.2	21	60	2.7	2.92		
8.0	8.0SIR0.2S-3537-1...	0.2	12	54	3.7	3.92	8.9	SMC...-8.0
	8.0SIR0.2M-3537-1...	0.2	20	70	3.7	3.92		
	8.0SIR0.2L-3537-1...	0.2	28	86	3.7	3.92		
10.0	10.0SIR0.2S-3547-1...	0.2	15	60	4.7	4.92	10.8	SMC...-10.0
	10.0SIR0.2M-3547-1...	0.2	25	80	4.7	4.92		
	10.0SIR0.2L-3547-1...	0.2	35	100	4.7	4.92		

Micro Kopierdrehen - für tieferes Hinterdrehen

Innen

RH - Einseitig

Micro - Einseitig

microscope

Einsatzdurchmesser	Bestellnummer	Abmessungen mm					Min. Bohrungsdurchmesser	Halter
d [mm]	RH/LH	R	L1	L	S max	F	mm	
4.0	M442CL R15 L10R/L	0.15	10	28	0.75	1.95	4.2	MHC...-4
	M442CL R15 L16R/L	0.15	16	33				
	M442CL R15 L21R/L	0.15	21	39				
5.0	M552CL R20 L16R/L	0.2	16	41	0.95	2.45	5.2	MHC...-5
	M552CL R20 L25R/L	0.2	25	51				
6.0	M662CL R20 L16R/L	0.2	16	42	1.75	2.95	6.2	MHC...-6
	M662CL R20 L21R/L	0.2	21	47				
	M662CL R20 L30R/L	0.2	30	56				

Microscope LH Werkzeug lieferbar auf Anfrage (Beispiel: M442CL R15 L10L)

Wendepatienten & Einsätze für die Innenbearbeitung

Micro-Rückwärts Plandrehen



Innen

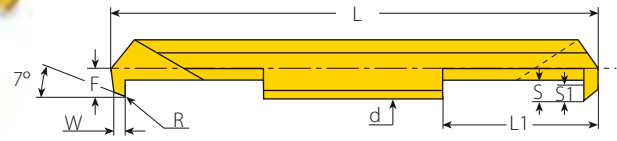
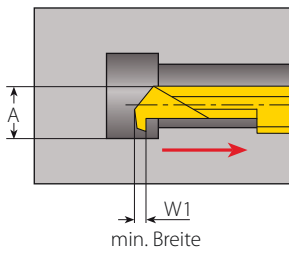

RH - Zweiseitig

Micro - Zweiseitig

Einsatzdurchmesser	Bestellnummer		Abmessungen mm								Min. Bohrungsdurchmesser	Halter
d [mm]	RH	R	L1	L	A	W	W1	S	S1	F	mm	
3.0	3.0SIR0.2S-Back-1...	0.05	9	36	3.42	1.5	1.81	0.8	0.6	1.42	3.2	SMC...-3.0
	3.0SIR0.2M-Back-1...	0.05	16	50								
4.0	4.0SIR0.2S-Back-1...	0.05	9	36	4.44	2.0	2.34	1.3	1.0	1.92	4.2	SMC...-4.0
	4.0SIR0.2M-Back-1...	0.05	16	50								
	4.0SIR0.2L-Back-1...	0.05	21	60								
6.0	6.0SIR0.2S-Back-1...	0.05	9	36	6.44	2.0	2.46	1.9	1.6	2.92	6.2	SMC...-6.0
	6.0SIR0.2M-Back-1...	0.05	16	50								
	6.0SIR0.2L-Back-1...	0.05	21	60								

Micro Bohrdrehen ins Volle

Innen

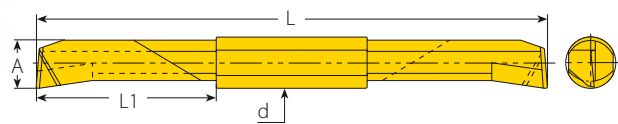
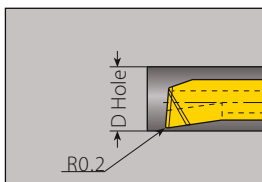

RH - Zweiseitig

Micro - Zweiseitig

Einsatzdurchmesser	Bestellnummer		Abmessungen mm			Min. Bohrungsdurchmesser	Halter
d [mm]	RH		L1	L	A	mm	
4.0	4.0SIR0.2M-BD-1...		16	50	3.53	3.74	SMC...-4.0
6.0	6.0SIR0.2M-BD-1...		16	50	5.20	5.80	SMC...-6.0
	6.0SIR0.2L-BD-1...		21	60			
8.0	8.0SIR0.2S-BD-1...		12	54	6.90	7.80	SMC...-8.0
	8.0SIR0.2M-BD-1...		20	70			
	8.0SIR0.2L-BD-1...		28	86			

Wendepatten & Einsätze für die Innenbearbeitung



Ausdrehen





> Klemmhalter

- Vardex Bestellnummernsystem Seite 182
- PowerBore Bohrstangen für CD0W- Wendepplatten Seite 183
- PowerBore Bohrstangen für TD0W- Wendepplatten Seite 184
- PowerBore Bohrstangen für WC0W- Wendepplatten (4213, 4214) Seite 185
- PowerBore Bohrstangen für WCOW- Wendepplatten (5013, 5014) Seite 186
- Klemmhalter - Micro Zweiseitig Seite 187
- Klemmhalter - Microscope Einseitig Seite 188

Vardex Bestellnummernsystem

PowerBore Halter

C	05	-	D	T	J	-	-	5
1	2		3	4	5			6
1 - Schaftart	2 - Schaft Ø	3 - Schaft Ø [D_i]		4 - Plattenform		5 - Halterlänge [L₂]		
C - Hartmetall S - Stahl	04 - 4.0 mm 05 - 5.0 mm 06 - 6.0 mm 08 - 8.0 mm 10 - 10.0 mm 12 - 12.0 mm	A - 4.2 B - 4.6 C - 4.8 D - 5.0 E - 5.2 F - 6.0 G - 6.4 H - 7.9 J - 8.0		C - Diamond 80 Deg.  T - Triangle  W - Trigon 80 Deg. 		A - 57 C - 64 D - 70 E - 76 G - 89 J - 102 P - 152		
						6 - Freiwinkel		
						0, 5, 7		

microscope

Micro und PowerBore Bohrstangen für CD0W- Wendepplatten

S	M	C	16	-	3
1	2	3	4		5
1 - Halterform	2 - Halter		3 - Kühlung	4 - Halterdurchmesser	5 - Bohrungs Ø
S - Hülse (Zweiseitig) M - Microscope (Einseitig)	M - Micro (Zweiseitig) H - Microscope (Einseitig)		C - Kühlkanal	10, 12, 16, 20	Spanndurchmesser 3, 4, 5, 6, 7, 8, 10

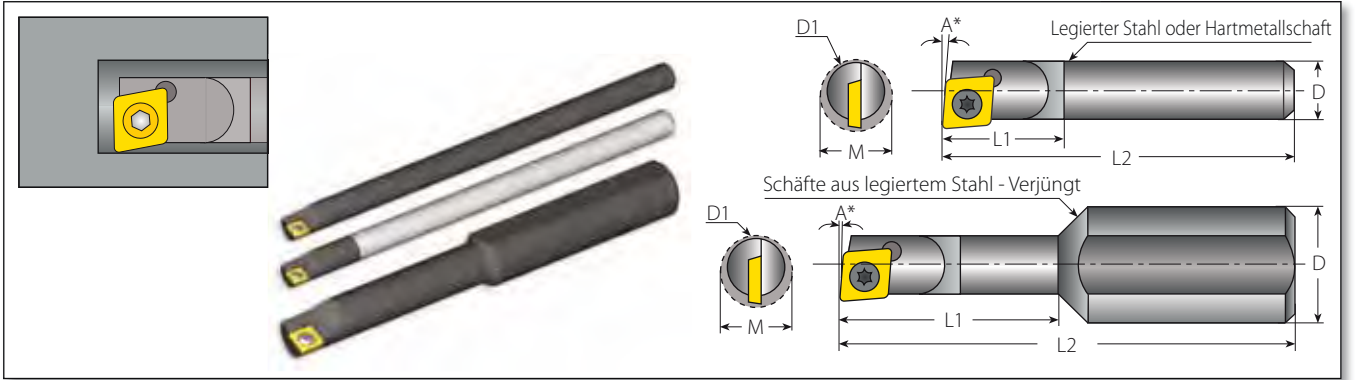

Schäfte aus legiertem Stahl - Standardabmessungen

Ersatzteile

Schaft	Bestellnummer	Abmessungen mm						Ersatzteile		
		A	D	D1	M	L2	L1	Platte	Schraube	Torx Schlüssel
		Winkel	Schaft Ø	Schaftdurchmesser	Min. Ø	Gesamtlänge	Länge			
5.0	S05-ACC--7	7°	5.0	4.2	4.6	64	12	CD0W	VS01	VT51
	S05-BCC--5	5°	5.0	4.6	5.3	64				
	S05-DCC--5	5°	5.0	5.0	6.1	64				
	S05-DCC--0	0°	5.0	5.0	6.4	64				
6.0	S06-FCE--5	5°	6.0	6.0	7.0	76	D1=D			
	S06-FCE--0	0°	6.0	6.0	7.3	76				

Hartmetallschaft mit Kopf aus legiertem Stahl - Standardabmessungen

Ersatzteile

Schaft	Bestellnummer	Abmessungen mm						Ersatzteile		
		A	D	D1	M	L2	L1	Platte	Schraube	Torx Schlüssel
		Winkel	Schaft Ø	Schaftdurchmesser	Min. Ø	Gesamtlänge	Länge			
4.0	C04-ACP--7	7°	4.0	4.2	4.6	152	12	CD0W	VS01	VT51
5.0	C05-CCJ--5	5°	5.0	4.8	5.5	102				
	C05-DCJ--5	5°	5.0	5.0	6.1	102				
	C05-DCJ--0	0°	5.0	5.0	6.5	102				
6.0	C06-FCJ--5	5°	6.0	6.0	7.0	102	D1=D			
	C06-FCJ--0	0°	6.0	6.0	7.3	102				

Schäfte aus legiertem Stahl - Verjüngt

Ersatzteile

Schaft	Bestellnummer	Abmessungen mm						Ersatzteile		
		A	D	D1	M	L2	L1	Platte	Schraube	Torx Schlüssel
		Winkel	Schaft Ø	Schaftdurchmesser	Min. Ø	Gesamtlänge	Länge			
8.0	S08-BCA--5	5°	8.0	4.6	5.5	57	25	CD0W	VS01	VT51
	S08-ECA--5	5°	8.0	5.2	5.8	57				
	S08-ECA--0	0°	8.0	5.2	6.2	57				
	S08-GCC--5	5°	8.0	6.4	7.4	64	32			
	S08-GCC--0	0°	8.0	6.4	7.6	64				

* 5° Winkel für Plandrehen und Drehen von Durchgangsbohrungen

* 0° Winkel für Drehen von Durchgangsbohrungen und Drehen gegen eine "Schulter"

PowerBore Bohrstangen für TD0W- Wendeplatten

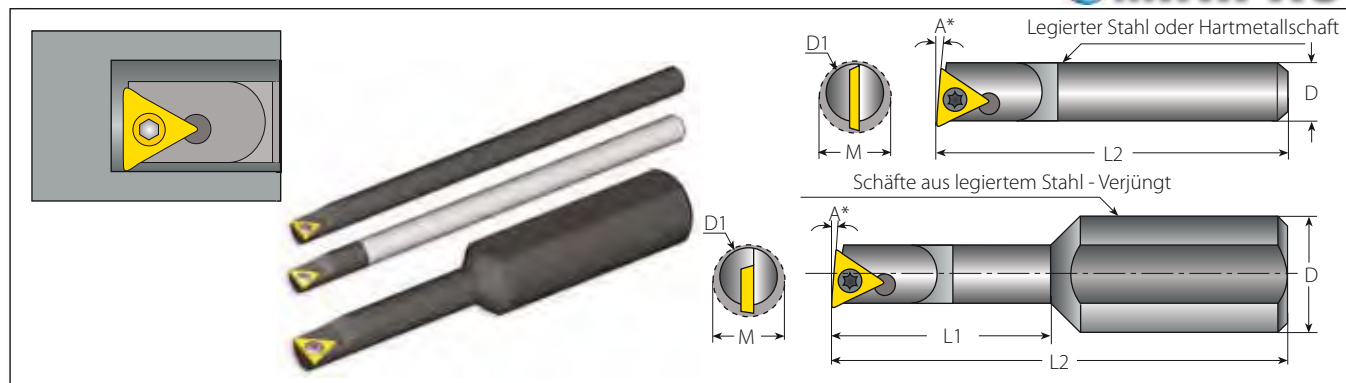

Schäfte aus legierten Stahl - Standardabmessungen

Ersatzteile

Schaft	Bestellnummer	Abmessungen mm				Winkel	Schraube	Torx Schlüssel
		A	D=D1	M	L2			
		Winkel	Schaftdurchmesser	Min. Ø	Gesamtlänge			
5.0	S05-DTG--5	5°	5.0	7.1	89	TD0W	VS01	VT51
	S05-DTG--0	0°	5.0	7.1	89			
6.0	S06-FTJ--5	5°	6.0	7.3	102			
	S06-FTJ--0	0°	6.0	7.3	102			
8.0	S08-JTJ--5	5°	8.0	9.2	102			
	S08-JTJ--0	0°	8.0	9.2	102			



Hartmetallschaft mit Kopf aus legiertem Stahl - Standardabmessungen

Ersatzteile

Schaft	Bestellnummer	Abmessungen mm				Winkel	Schraube	Torx Schlüssel
		A	D=D1	M	L2			
		Winkel	Schaftdurchmesser	Min. Ø	Gesamtlänge			
5.0	C05-DTJ--5	5°	5.0	7.1	102	TD0W	VS01	VT51
	C05-DTJ--0	0°	5.0	7.1	102			
6.0	C06-FTJ--5	5°	6.0	7.3	102			
	C06-FTJ--0	0°	6.0	7.3	102			
8.0	C08-JTJ--5	5°	8.0	9.2	102			
	C08-JTJ--0	0°	8.0	9.2	102			



Schäfte aus legiertem Stahl - Verjüngt

Ersatzteile

Schaft	Bestellnummer	Abmessungen mm						Winkel	Schraube	Torx Schlüssel
		A	D	D1	M	L2	L1			
		Winkel	Schaft Ø	Schaftdurchmesser	Min. Ø	Gesamtlänge	Länge			
12.0	S12-ETC--5	5°	12.0	5.2	6.9	64	25	VS01	TD0W	VT51
	S12-ETC--0	0°	12.0	5.2	6.9	64				
	S12-GTD--5	5°	12.0	6.4	7.6	70	32	VS40		
	S12-GTD--0	0°	12.0	6.4	7.6	70				
	S12-HTE--5	5°	12.0	7.9	9.1	76	38	VS40		
	S12-HTE--0	0°	12.0	7.9	9.1	76				

PowerBore Bohrstangen für WC0W- Wendepplatten (4213, 4214)

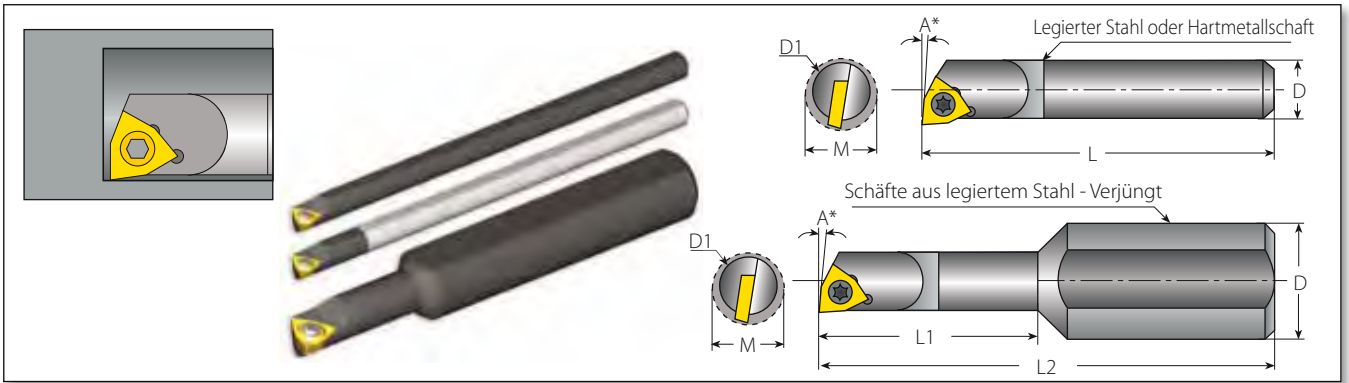

PowerBore

Ersatzteile

Schäfte aus legierten Stahl - Standardabmessungen

Schaft	Bestellnummer	Abmessungen mm				Platte	Schraube	Torx Schlüssel
		A	D=D1	M	L			
		Winkel	Schaftdurchmesser	Min. Ø	Länge			
5.0	S05-DWC--5	5°	5.0	6.1	64	WC0W4213	VS40	VT51
	S05-DWC--0	0°	5.0	6.4				
6.0	S06-FWJ--5	5°	6.0	7.0	102			
	S06-FWJ--0	0°	6.0	7.3				

PowerBore

Ersatzteile

Hartmetallschaft mit Kopf aus legiertem Stahl - Standardabmessungen

Schaft	Bestellnummer	Abmessungen mm				Platte	Schraube	Torx Schlüssel
		A	D=D1	M	L			
		Winkel	Schaftdurchmesser	Min. Ø	Länge			
5.0	C05-DWJ--5	5°	5.0	6.1	102	WC0W4213	VS40	VT51
	C05-DWJ--0	0°	5.0	6.4				
6.0	C06-FWJ--5	5°	6.0	7.0	102			
	C06-FWJ--0	0°	6.0	7.3				

PowerBore

Ersatzteile

Schäfte aus legiertem Stahl - Verjüngt

Schaft	Bestellnummer	Abmessungen mm						Platte	Schraube	Torx Schlüssel
		A	D	D1	M	L2	L1			
		Winkel	Schaft Ø	Schaftdurchmesser	Min. Ø	Gesamtlänge	Länge			
10.0	S10-EWA--5	5°	10.0	5.2	5.8	57	13	WC0W4213	VS40	VT51
	S10-EWA--0	0°	10.0	5.2	6.2	57				
	S10-GWC--5	5°	10.0	6.4	7.4	64	19			
	S10-GWC--0	0°	10.0	6.4	7.6	64				

* 5° Winkel für Plandrehen und Drehen von Durchgangsbohrungen

* 0° Winkel für Drehen von Durchgangsbohrungen und Drehen gegen eine "Schulter"

PowerBore Bohrstangen für WC0W- Wendeplatten (5013, 5014)

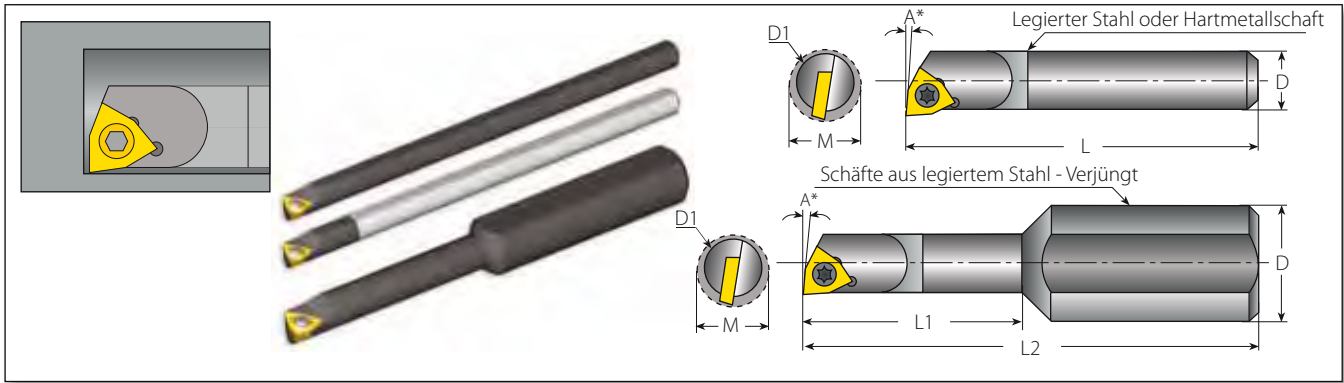

PowerBore

Schäfte aus legierten Stahl - Standardabmessungen

Ersatzteile

Schaft	Bestellnummer	Abmessungen mm				Platte	Schraube	Torx Schlüssel
		A	D=D1	M	L			
		Winkel	Schaftdurchmesser	Min. Ø	Länge			
8.0	S08-JWJ--5	5°	8.0	9.2	102	WC0W5013	VS41	VT51
	S08-JWJ--0	0°	8.0	9.2				

PowerBore

Hartmetallschaft mit Kopf aus legiertem Stahl - Standardabmessungen

Ersatzteile

Schaft	Bestellnummer	Abmessungen mm				Platte	Schraube	Torx Schlüssel
		A	D=D1	M	L			
		Winkel	Schaftdurchmesser	Min. Ø	Länge			
8.0	C08-JWJ--5	5°	8.0	9.2	102	WC0W5013	VS41	VT51
	C08-JWJ--0	0°	8.0	9.2				

PowerBore

Schäfte aus legiertem Stahl - Verjüngt

Ersatzteile

Schaft	Bestellnummer	Abmessungen mm						Platte	Schraube	Torx Schlüssel
		A	D	D1	M	L2	L1			
		Winkel	Schaft Ø	Schaftdurchmesser	Min. Ø	Gesamtlänge	Länge			
10.0	S10-HWE--5	5°	10.0	7.9	9.2	76	38	WC0W5013	VS41	VT51
	S10-HWE--0	0°	10.0	7.9	9.2	76				

Klemmhalter für die Innenbearbeitung



Micro - Zweiseitig

Ersatzteile



Micro-Einsatz Einsatzdurchmesser	Schaft durch- messer	Bestellnummer	Abmessungen mm			Justierschraube*			Befestigungsschraube x 3						
			L	L1	L0	Schraube	M	Schlüssel	Schraube	Schlüssel					
3	10	SMC10-3.0	80	9- Kurz	89	4GISM8X28	28	K4.0	M4X0.7X4.0	K2.0					
	12	SMC12-3.0		16- Mittel	96	4GISM8X21	21								
	16	SMC16-3.0	95	9- Kurz	104	4GISM8X49	49								
	20	SMC20-3.0		16- Mittel	111	4GISM8X42	42								
4	10	SMC10-4.0	80	9- Kurz	89	4GISM8X28	28				K4.0	M4X0.7X4.0	K2.0		
	12	SMC12-4.0		16- Mittel	96	4GISM8X21	21								
	16	SMC16-4.0	95	9- Kurz	104	4GISM8X49	49								
	20	SMC20-4.0		16- Mittel	111	4GISM8X42	42								
6	12	SMC12-6.0	80	9- Kurz	89	4GISM8X28	28		K4.0	M4X0.7X4.0				K2.0	
	16			16- Mittel	96	4GISM8X21	21								
	20			21- Lang	101	4GISM8X16	16								
	16	SMC16-6.0	95	9- Kurz	104	4GISM8X49	49								
20	SMC20-6.0	16- Mittel		111	4GISM8X42	42									
8	16	SMC16-8.0	95	9- Kurz	104	4GISM8X49	49	K4.0				M4X0.7X4.0	K2.0		
	20			16- Mittel	111	4GISM8X42	42								
	28- Lang			123	4GISM8X17	17									
	12- Kurz	107	4GISM8X33	33											
10	16	SMC16-10.0	95	20- Mittel	115	4GISM8X25	25			K4.0	M6X1.0X5.0			K3.0	
	20			SMC20-8.0	28- Lang	123	4GISM8X17								17
	15- Kurz			110	4GISM8X30	30									
	25- Mittel	120	4GISM8X20	20											
35- Lang	130	4GISM8X10	10												

Jeder Klemmhalter Set enthält alle benötigten Justierschrauben

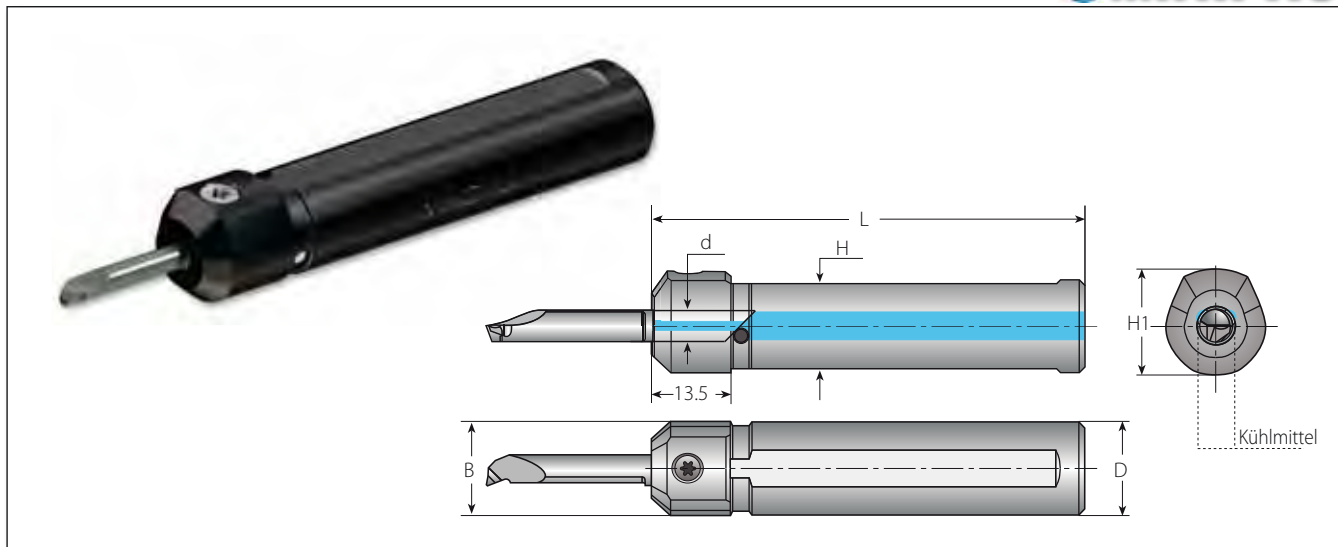

Micro - Einseitig

Ersatzteile **microscope**

Micro- Einsatz Ø	Bestellnummer	Abmessungen (mm)					
d [mm]		D=B	H1	H	L	Befestigungsschraube	Schlüssel
4.0	MHC 10-4	10	14	8.8	65	SL7DT15	KT15
	MHC 12-4	12	16	10.8	70		
	MHC 16-4	16	17.6	14.8	75		
	MHC 20-4	20	22	18.8	84		
5.0	MHC 10-5	10	14	8.8	65		
	MHC 12-5	12	16	10.8	70		
	MHC 16-5	16	18.6	14.8	75		
	MHC 20-5	20	22	18.8	84		
6.0	MHC 12-6	12	16	10.8	70		
	MHC 16-6	16	18.6	14.8	75		
	MHC 20-6	20	22	18.8	84		
7.0	MHC 16-7	16	18.6	14.8	75		
	MHC 20-7	20	22	18.8	84		

Einfaches Spannsystem

Einfach und prozesssicher - das neue Spannsystem verwendet eine Schraube, um den Schneideinsatz im Halter zu sichern

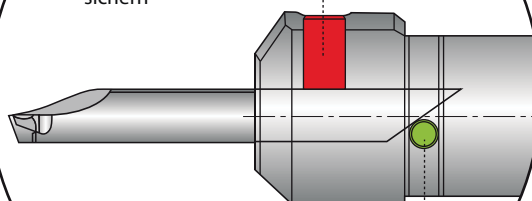

Anschlagstift

ermöglicht eine präzise Spitzenhöhe und eine perfekte axiale Ausrichtung

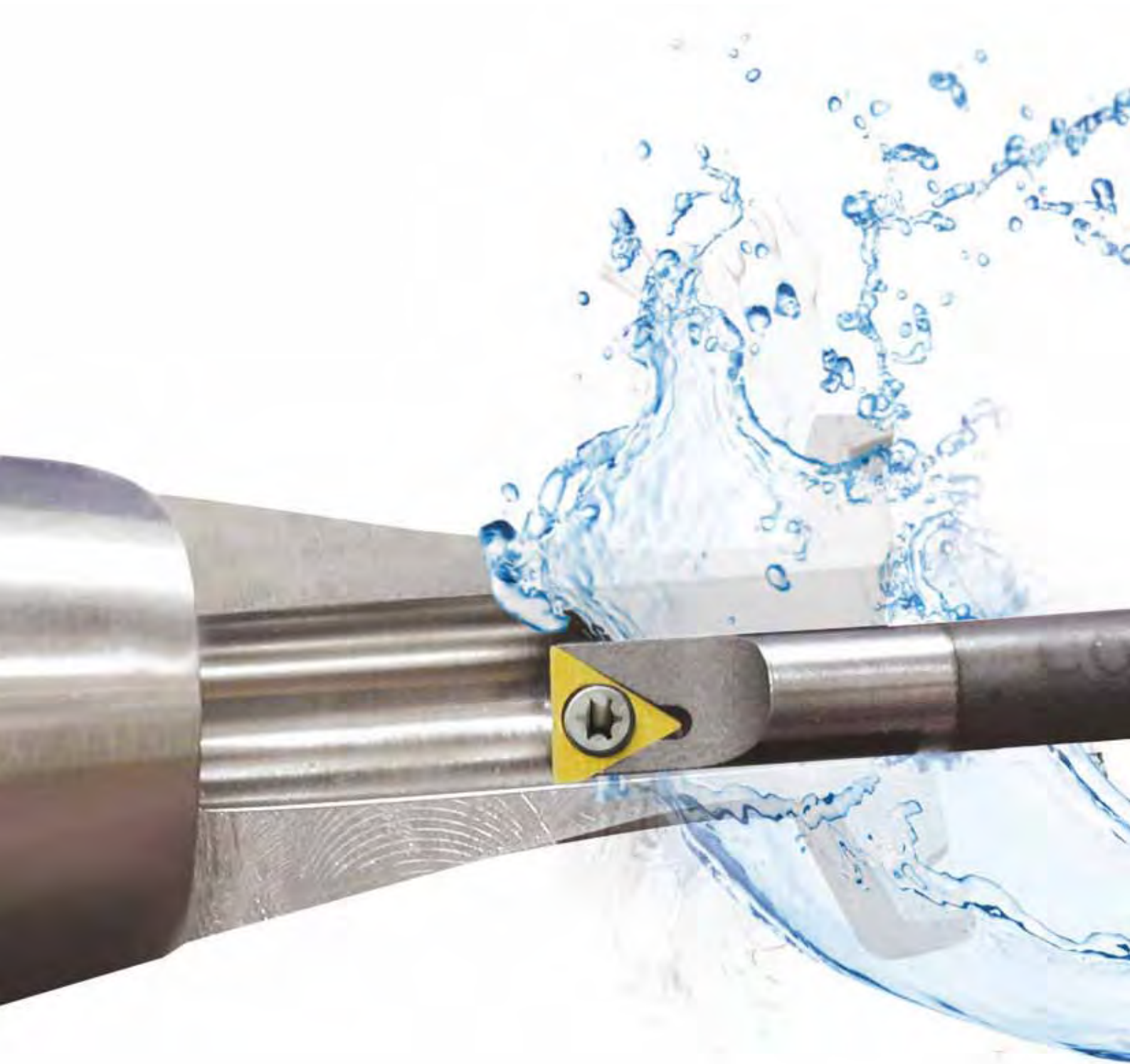





Ausdrehen



> Technische Daten

- Ersatzteile PowerBore..... Seite 190
- Empfohlene Schnittdaten - PowerBore & Micro..... Seite 191
- Sorten und ihre Anwendungen..... Seite 191

Ersatzteile PowerBore					
Platte	Bohrstange	Platte	Torx Schraube	Schraube Beschreibung	Torx Schlüssel
	A	CD0W	VS01	1-72 Oval X 2.77LG.	VT51
	B	TD0W Min. Bore 7.1 > Bore 7.1	VS01 VS40	1-72 Oval X 2.77LG. M2 X 0.4 X 3.86LG.	
	E	WC0W4213, WC0W4214	VS40	M2 X 0.4 X 3.86LG.	
	F	WC0W5013, WC0W5014	VS41	M2 X 0.4 X 4.90LG.	

Empfohlene Sorten und Schnittgeschwindigkeiten Vc [m/min], + Vorschub Vf [mm/U] und max. Tiefe [mm]

Material- gruppe	Vardex Nr.	Material	Härte Brinell HB	Vc [m/min]		Vorschub [mm/U]		Max. Tiefe [mm]				
				Beschichtet		Power Bore	Micro/ Microscope	PowerBore			Micro / Microscope	
				VTX (PowerBore)	VMX/ VBX (Micro & Microscope)			CD0W	TD0W	WD0W		
P Stahl	1	Unlegierter Stahl	Geringer Kohlenstoffanteil (C=0.1-0.25%)	125	115-190	50-120	0.25	0.05	0.5	0.45	0.6	0.4
	2		Mittlerer Kohlenstoffanteil (C= 0.25- 0.55%)	150	100-175	40-100	0.2	0.04	0.5	0.45	0.6	0.4
	3		Hoher Kohlenstoffanteil (C= 0.55- 0.85%)	170	90-165	30-80	0.15	0.03	0.5	0.45	0.6	0.4
	4	Niedriglegierter Stahl (Legierungs- Elemente ≤ 5%)	Ungehärtet	180	85-145	50-70	0.2	0.04	0.4	0.35	0.5	0.3
	5		Gehärtet	275	75-140	40-60	0.15	0.04	0.4	0.35	0.5	0.3
	6		Gehärtet	350	70-135	30-50	0.1	0.03	0.4	0.35	0.5	0.3
	7	Hochlegierter Stahl (Legierungs- Elemente > 5%)	Vergütet	200	70-110	30-50	0.1	0.04	0.2	0.18	0.4	0.15
	8		Gehärtet	325	50-100	25-40	0.05	0.03	0.2	0.18	0.4	0.15
	9	Stahlguss	Niedriglegiert (Legierungs- Elemente ≤ 5%)	200	75-140	30-50	0.25	0.04	0.2	0.18	0.4	0.15
	10		Hochlegiert (Legierungs- Elemente > 5%)	225	60-120	25-40	0.1	0.04	0.2	0.18	0.4	0.15
M Edelstahl	11	Edelstahl Ferritisch	Ungehärtet	200	70-130	60-100	0.2	0.04	0.25	0.22	0.5	0.2
	12		Gehärtet	330	60-115	40-60	0.08	0.03	0.2	0.18	0.4	0.15
	13	Edelstahl Austenitisch	Austenitisch	180	90-140	50-90	0.2	0.04	0.25	0.22	0.5	0.2
	14		Super- Austenitisch	200	40-110	40-60	0.08	0.04	0.2	0.18	0.4	0.15
	15	Edelstahlguß Ferritisch	Ungehärtet	200	90-120	40-60	0.2	0.04	0.25	0.22	0.5	0.2
	16		Gehärtet	330	65-110	30-50	0.08	0.03	0.2	0.18	0.4	0.15
	17	Edelstahl Guss austenitisch	Austenitisch	200	85-110	40-60	0.2	0.04	0.25	0.22	0.5	0.2
	18		Gehärtet	330	60-100	30-50	0.08	0.03	0.2	0.18	0.4	0.15
K Gußeisen	28	Temperguss	Ferritisch (kurzspanig)	130	70-160	50-70	0.15	0.02	0.3	0.3	0.4	0.25
	29		Perlitisch (langspanig)	230	60-145	50-70	0.10	0.01	0.3	0.3	0.4	0.25
	30	Grauguss	Niedrigfest	180	70-130	50-70	0.15	0.02	0.5	0.45	0.6	0.4
	31		Hochfest	260	60-115	40-60	0.1	0.01	0.5	0.45	0.6	0.4
	32	Kugelgraphitguss	Ferritisch	160	125-160	50-70	0.15	0.02	0.5	0.45	0.6	0.4
33	Perlitisch		260	90-120	60-80	0.1	0.01	0.5	0.45	0.6	0.4	
N(K) Nichteisen- Metalle	34	Schmiedeeisen	ungealtert	60	100-365	100-300	0.3	0.03	0.76	0.63	1.0	0.5
	35	Aluminium- Legierungen	gealtert	100	80-220	100-150	0.2	0.03	0.76	0.63	1.0	0.5
	36		Guß	75	200-400	100-150	0.3	0.03	0.76	0.63	1.0	0.5
	37	Aluminium- Legierungen	Guß & gealtert	90	200-280	60-100	0.2	0.03	0.76	0.63	1.0	0.5
	38		Guß Si 13- 22%	130	60-180	100-150	0.3	0.02	0.76	0.63	1.0	0.5
	39	Kupfer und Kupferlegierungen	Messing	90	80-225	60-100	0.3	0.03	0.76	0.63	1.0	0.5
40	Bronze und bleifreies Kupfer		100	80-255	60-100	0.2	0.03	0.76	0.63	1.0	0.5	
S(M) Hitzebe- ständige Material	19	Hochtemperaturlegie- rungen	Vergütet (Eisen basiert)	200	45-60	25-45	0.2	0.04	0.25	0.22	0.5	0.2
	20		Gealtert (Eisen basiert)	280	30-50	20-30	0.08	0.03	0.2	0.18	0.4	0.15
	21		Vergütet (Nickel oder Cobalt basiert)	250	20-30	15-20	0.08	0.01	0.2	0.18	0.4	0.15
	22		Gealtert (Nickel oder Cobalt basiert)	350	15-25	10-15	0.05	0.01	0.2	0.18	0.4	0.15
	23	Titanlegierungen	Reines 99,5 Ti	400Rm	140-170	60-100	0.05	0.02	0.2	0.18	0.4	0.15
24	α+β Legierungen		1050Rm	50-70	40-50	0.05	0.02	0.2	0.18	0.4	0.15	
H(K) Gehärtet Material	25	Extra harter Stahl	Gehärtet & angelassen	45- 50HRc	45-65	20-45	0.02	0.01	0.1	0.05	0.2	0.05
	26			51- 55HRc	45-60	20-40	0.01	0.01	0.05	0.05	0.1	0.05

Sorten und ihre Anwendungen

VTX

Erste Wahl für alle Anwendungen.
TiAlN- Beschichtung.

VMX

Erste Wahl für alle Anwendungen
für Micro- Platten. TiN-farbige PVD-Beschichtung.

VBX

Erste Wahl für alle Anwendungen
für Microscope Platten. TiCN- Beschichtung.

FRÄSEN

> **Gewindefräsen**

Standardsystem

MiTM

TMSD

Vollhartmetall

> **Stechfräsen**

FRÄSEN

Gewindedrehen

■ Das richtige Werkzeug für das Gewindefräsen.....	Seite 195
■ Gewindefräsmethoden.....	Seite 196
■ Werkzeugempfehlung für die Bearbeitung von Innengewinden mit Standardsystem.....	Seite 197
■ Gewindefräsplatten (Standardsystem).....	Seite 208
■ Gewindefrästrägerkörper (Standardsystem).....	Seite 234
■ Technische Daten - Gewindefräsen.....	Seite 244
■ MiTM Schneidplatten.....	Seite 255
■ MiTM Trägerkörper und Werkzeugempfehlung.....	Seite 260
■ Technische Daten - MiTM.....	Seite 265
■ TMSD Schneidplatten.....	Seite 270
■ TMSD Trägerkörper und Werkzeugempfehlung.....	Seite 271
■ Technische Daten - TMSD.....	Seite 273
■ TM Solid Vollhartmetal.....	Seite 280
■ TM Solid Vollhartmetal Technische Daten.....	Seite 305

Stechen

■ Stechfräsplatten.....	Seite 311
■ Stechfrässchäfte.....	Seite 314
■ Technische Daten - Stechfräsen.....	Seite 316

VARGUS TM Gen Software für CNC Programmierung

Gewindefräs Software

Um Sie ins VARDEX Gewindefrässystem einzuführen, hat VARGUS eine mehrsprachig CD für die CNC-Programmierung entwickelt.

Der Maschinenbediener gibt lediglich die Grundgewindeparameter ein und folgt dann den Instruktionen des Computers, welche ihn zur richtigen Wahl des Werkzeugs für die betreffende Anwendung führen. Die Software erzeugt dann die "Helikalinterpolation" für die CNC - Steuerung. Es könnte nicht einfacher sein!

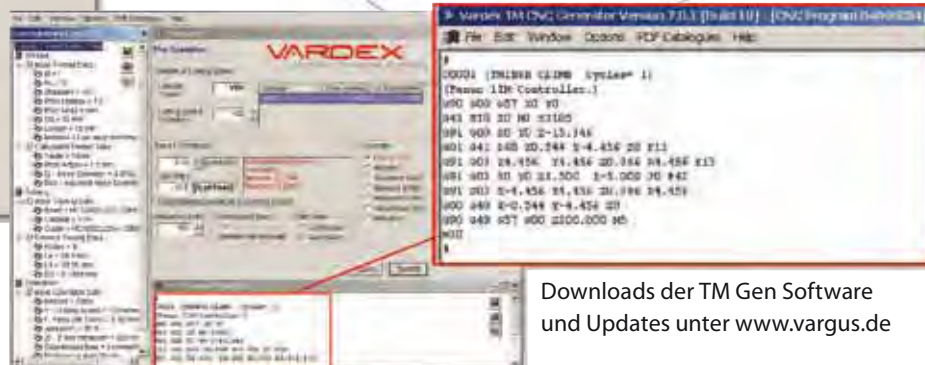

Downloads der TM Gen Software
und Updates unter www.vargus.de

Das richtige Werkzeug für das Gewindefräsen!

übliche Gewinde	Standard Gewinde  von M15x1.0 (9/16"x32UN) TMC	Konische Gewinde  von 1/4"x18NPT TMNC	Regelgewinde  von M10x0.75 (7/16"x20UNF) TMC/124...	
	kurze und lange Gewinde  ab Teilung 0,35mm (80TPI) TMSC	Lange Gewinde  bis zu 98.0mm (3.86") TMLC	Extra lange Gewinde  bis zu 144mm (5.7") TMSD	Extra lange Gewinde  bis zu 200mm (7.88") TMSD Fräskopf
	kleine und große Teilungen  ab Teilung 0,35mm (80TPI) TMC	Fein  ab Teilung 0,35mm (80TPI) TMC	groß - Kammpatte  bis zu ISO 6.0 (4UN) BTMC...-B	groß - Einzahn  bis zu ISO 6.0 (4UN) TMOG
weniger Durchgänge	lange Schneidplatten  bis zu 38.9mm (1.53") BTMC...-B	versetzte Schneidplatten  Effektive Länge bis zu 50.8mm (2.0") TMOG		
	mehr Plattensitze für schnelle Bearbeitungen  bis zu 5 Plattensitze MITM	kleine & mittlere  2 Plattensitze TM2	mittlere Durchmesser  bis zu 9 Plattensitze Fräskopf	große Durchmesser  bis zu 8 Plattensitze MiTM Fräskopf
kleine Gewindedurchmesser	austauschbare Schneiden  Von M10x0.75 (7/16"x32UN) TMMC	extrem kleine Gewinde  ab M1.0x0.25 (0-80UNF) bis zu 62 HRC Millipro Millipro HD	Lange Gewinde  ab M6x1, max. Gewindelänge 63mm TM Solid tiefe Gewinde	
	für allgemeine Anwendungen  ab M4.5x0.75 (No.8-36UNF) gerade Spannuten	für anspruchsvollere Anwendungen  ab M3x0.5 (No.10-32UNF) Helicool	radialer Kühlmittelaustritt  ab M6x1.0 Helicool-R (HCR)	
	Helicool+Fasen  ab M6x1.0 Helicool-C (HCC)	kostengünstiges Werkzeug  ab M3x0.5 (No.8-36UNF) Spiralgenutet	Bohren, Gewinden und Fasen  ab M6x1.0 HTC	

Gewindefräsmethoden

Außen

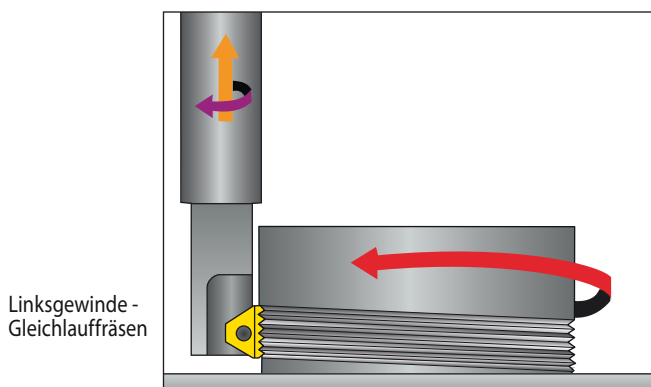
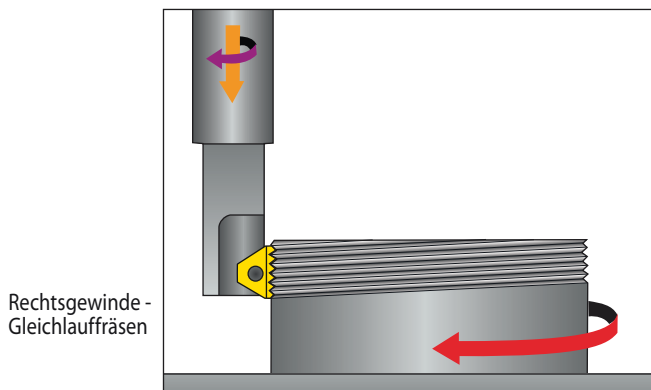
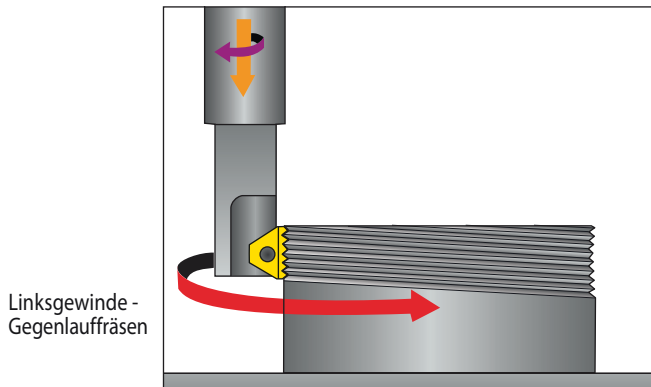
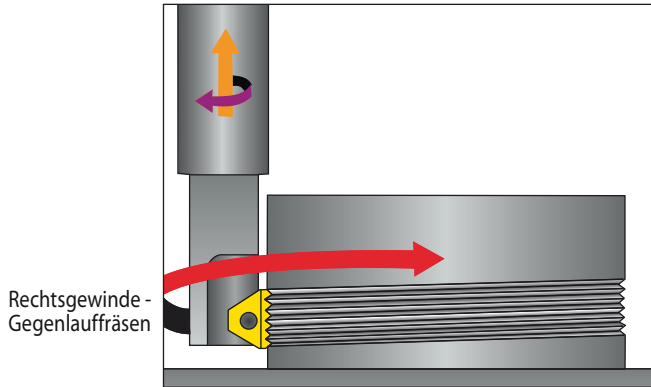

Innen

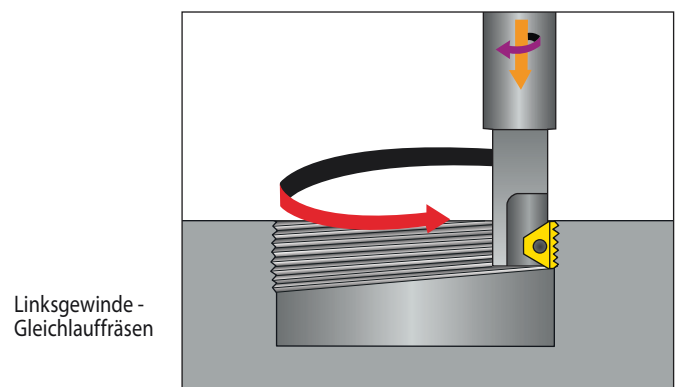
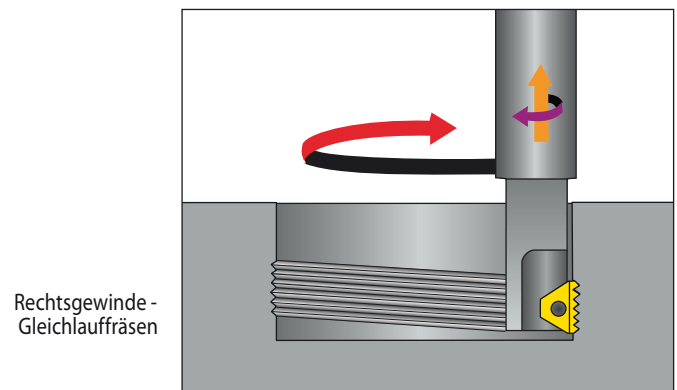
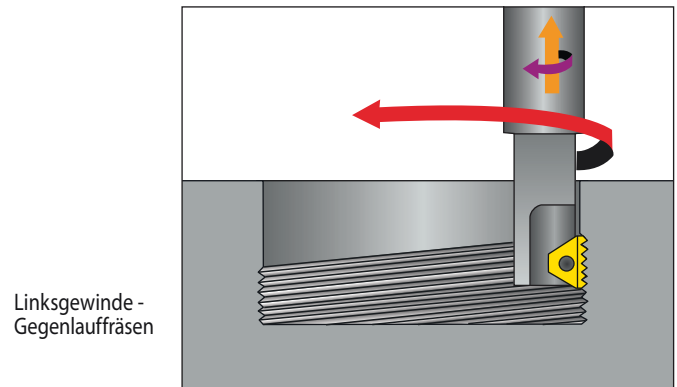
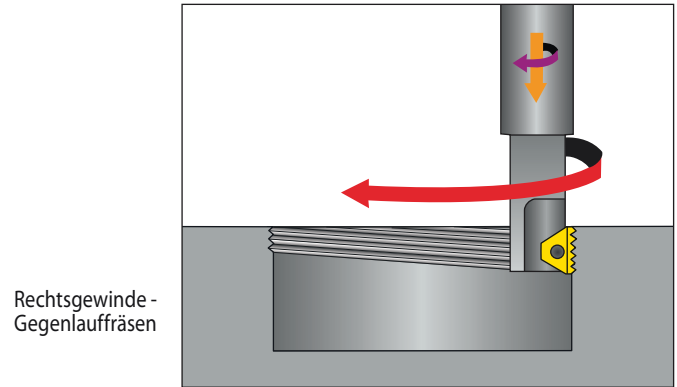

Werkzeugempfehlung* für Standardsystem

(MiTM Werkzeuge auf Seite 254)

(TMSD Werkzeuge auf Seite 268)

(TM Vollhartmetall-Werkzeuge auf Seite 278)

Downloads der TM Gen
Software und Updates
unter www.vargus.de



ISO - Innen

Teilung mm	Nenndurchmesser mm	Halter	Wendeplatte	L1- Schaft Ausraglänge	D2- Werkzeug Fräser Ø*	hmin. - Gewindeprofiltiefe	
0.75	10	TMMC12-6.0	6.0I0.75ISOTM...028/001	12.0	9.0	0.43	
	11	TMMC12-6.0	6.0I0.75ISOTM...	12.0	9.0		
	12-14	TMMC12-6.0	6.0I1.0ISOTM...	12.0	9.0		
	15-18	TMC12-2	2I1.0ISOTM2...	12.0	11.5		
	20	TMC16-3	3I1.0ISOTM2...	22.0	17.0		
1.0	22	BTMC20-3B	3BI1.0ISOTM2...	29.0	19.0	0.58	
	24	TMC20-3	3I1.0ISOTM2...	43.0	20.0		
	25-28	TMLC25-3	3I1.0ISOTM2...	25.0	22.0		
	30	TM2C25-3	3I1.0ISOTM2...	43.0	26.0		
	12	TMMC12-6.0	6.0I1.25ISOTM...028/002	12.0	9.0		0.72
14	TMMC12-6.0	6.0I1.25ISOTM...	12.0	9.0			
14-15	TMMC12-6.0	6.0I1.5ISOTM...	12.0	9.0			
16-20	TMC12-2	2I1.5ISOTM2...	12.0	11.5			
22	TMC16-3	3I1.5ISOTM2...	22.0	17.0			
1.5	24	BTMC20-3B	3BI1.5ISOTM2...	29.0	19.0	0.87	
	25-26	TMC20-3	3I1.5ISOTM2...	43.0	20.0		
	27-30	TMLC25-3	3I1.5ISOTM2...	25.0	22.0		
	32-33	TM2C25-3	3I1.5ISOTM2...	43.0	26.0		
	35-42	TMC25-5	5I1.5ISOTM2...	52.0	30.0		
	45	TMC32-5	5I1.5ISOTM2...	58.0	37.0		
	48-55	TM2C32-5	5I1.5ISOTM2...	45.0	42.0		
	56-68	TMSH-D50-22-3	3I1.5ISOTM2...		50.0		
	70-80	TMSH-D63-22-5	5I1.5ISOTM2...		63.0		
1.75	12	TMMC20-6.0 124/003	6.0I1.75ISOTM...028/003	15.0	9.0	1.01	
	14-20	TMC12-2	2I2.0ISOTM...028/004	12.0	11.5		
	22	TMNC16-3	3I2.0ISOTM2...	22.0	15.5		
	24	TMC16-3	3I2.0ISOTM2...	22.0	17.0		
	25	BTMC20-3B	3BI2.0ISOTM2...	29.0	19.0		
	27	TMC20-3	3I2.0ISOTM2...	43.0	20.0		
	28-32	TMLC25-3	3I2.0ISOTM2...	25.0	22.0		
	33-36	TM2C25-3	3I2.0ISOTM2...	43.0	26.0		
	39-42	TMC25-5	5I2.0ISOTM2...	52.0	30.0		
	45-48	TMC32-5	5I2.0ISOTM2...	58.0	37.0		
	50-56	TM2C32-5	5I2.0ISOTM2...	45.0	42.0		
	58-68	TMSH-D50-22-3	3I2.0ISOTM2...		50.0		
	70-85	TMSH-D63-22-5	5I2.0ISOTM2...		63.0		
2.0	90-105	TMSH-D80-27-5	5I2.0ISOTM2...		80.0	1.15	
	110-130	TMSH-D100-32-5	5I2.0ISOTM2...		100.0		
	135-150	TMSH-D125-40-5	5I2.0ISOTM2...		125.0		
	20	TMC16-3 124/001	3I2.5ISOTM...028/005	20.5	15.50		1.44
	22	TMC25-4 124/002	4I2.5ISOTM...028/006	30.0	18.0		

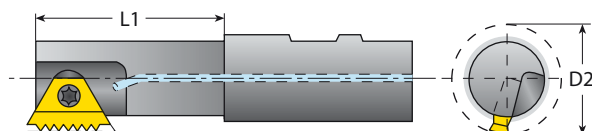

* Die Halterempfehlung ist für die grösste der gegebenen Gewindespezifikationen.

Ein Halter für kleinere oder gleiche Durchmesser (D2) kann ebenfalls benutzt werden (außer Schneidplatten 028/...)

Werkzeugempfehlung für Standardsystem (Fortsetzung)*

(MiTM Werkzeuge auf Seite 254)

(TMSD Werkzeuge auf Seite 268)

(TM Vollhartmetall-Werkzeuge auf Seite 278)

Downloads der TM Gen
Software und Updates
unter www.vargus.de



ISOInnen (Fortsetzung)

Teilung	Nenndurchmesser	Halter	Wendeplatte	L1- Schaft Ausraglänge	D2- Werkzeug Fräser Ø*	hmin. - Gewindeprofiltiefe
mm	mm					
3.0	24-33	TMC25-4 124/002	4I3.0ISOTM...028/007	30.0	18.0	1.73
	36-40	TMC25-5	5I3.0ISOTM...028/009	52.0	30.0	
	42-48	TMC25-5	5I3.0ISOTM2...	52.0	30.0	
	50-52	TMC32-5	5I3.0ISOTM2...	58.0	37.0	
	55-72	TM2C32-5	5I3.0ISOTM2...	45.0	42.0	
	75-90	TMSH-D63-22-5	5I3.0ISOTM2...		63.0	
	95-110	TMSH-D80-27-5	5I3.0ISOTM2...		80.0	
	115-135	TMSH-D100-32-5	5I3.0ISOTM2...		100.0	
3.5	140-250	TMSH-D125-40-5	5I3.0ISOTM2...		125.0	2.02
	30-33	TMC25-5 124/004	5I3.5ISOTM...028/008	40.0	25.0	
4.0	36-42	TMC25-5	5I4.0ISOTM...028/010	52.0	30.0	2.31
	45-52	TMC25-5	5I4.0ISOTM2...	52.0	30.0	
	55	TMC32-6B	6BI4.0ISOTM2...	55.0	35.0	
	56-58	TMC32-5	5I4.0ISOTM2...	58.0	37.0	
	60-65	TMC40-6B	6BI4.0ISOTM2...	65.0	46.0	
	68-76	TM2C40-6B	6BI4.0ISOTM2...	65.0	52.0	
	80-90	TMSH-D63-22-6B	6BI4.0ISOTM2...		63.0	
	95-110	TMSH-D80-27-6B	6BI4.0ISOTM2...		80.0	
	115-135	TMSH-D100-32-6B	6BI4.0ISOTM2...		100.0	
	140-300	TMSH-D125-40-6B	6BI4.0ISOTM2...		125.0	
4.5	42-45	TMC25-5	5I4.5ISOTM...028/011	52.0	30.0	2.60
5.0	48-52	TMC25-5	5I5.0ISOTM...028/075	52.0	30.0	2.89
		TMC32-6B	6BI5.0ISOTM2...	55.0	35.0	
5.5	56	TMC32-6B	6BI5.5ISOTM2...	55.0	35.0	3.17
	60	TMC40-6B	6BI5.5ISOTM2...	65.0	46.0	
	64-68	TMC40-6B	6BI6.0ISOTM2...	65.0	46.0	
6.0	70-80	TM2C40-6B	6BI6.0ISOTM2...	65.0	52.0	3.46
	85-100	TMSH-D63-22-6B	6BI6.0ISOTM2...		63.0	
	105-120	TMSH-D80-27-6B	6BI6.0ISOTM2...		80.0	
	125-145	TMSH-D100-32-6B	6BI6.0ISOTM2...		100.0	
	150-300	TMSH-D125-40-6B	6BI6.0ISOTM2...		125.0	

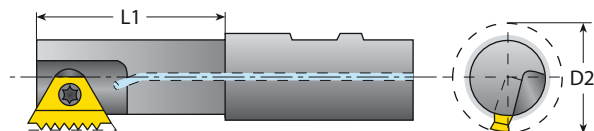

* Die Halterempfehlung ist für die grösste der gegebenen Gewindefspezifikationen.

Ein Halter für kleinere oder gleiche Durchmesser (D2) kann ebenfalls benutzt werden (außer Schneidplatten 028/...)

Werkzeugempfehlung für Standardsystem (Fortsetzung)*

(MiTM Werkzeuge auf Seite 254)

(TMSD Werkzeuge auf Seite 268)

(TM Vollhartmetall-Werkzeuge auf Seite 278)

Downloads der TM Gen
Software und Updates
unter www.vargus.de



UN - Innen

Teilung	Nenndurchmesser	Halter	Wendeplatte	L1- Schaft	D2- Werkzeug	hmin.
G/Z	Zoll			Auskräglänge	Fräser Ø*	Gewindeprofiltiefe
32	7/16-1/2	TMMC12-6.0	6.0I32UNTM...	12.0	9.0	0.46
	9/16-11/16	TMC12-2	2I32UNTM2...	12.0	11.5	
	3/4-13/16	TMC16-3	3I32UNTM2...	22.0	17.0	
	7/8-15/16	TMC20-3	3I32UNTM2...	43.0	20.0	
	1	TMLC25-3	3I32UNTM2...	25.0	22.0	
28	7/16-1/2	TMMC12-6.0	6.0I28UNTM...	12.0	9.0	0.52
	9/16-3/4	TMC12-2	2I28UNTM2...	12.0	11.5	
	13/16-7/8	TMC16-3	3I28UNTM2...	22.0	17.0	
	15/16	TMC20-3	3I28UNTM2...	43.0	20.0	
	1-1 1/8	TMLC25-3	3I28UNTM2...	25.0	22.0	
24	1 3/16-1 1/2	TM2C25-3	3I28UNTM2...	43.0	26.0	0.61
	9/16-11/16	TMC12-2	2I24UNTM2...	12.0	11.5	
20	7/16	TMMC12-6.0	6.0I20UNTM...028/012	12.0	9.0	0.73
	1/2-9/16	TMMC12-6.0	6.0I20UNTM...	12.0	9.0	
	5/8-13/16	TMC12-2	2I20UNTM2...	12.0	11.5	
	7/8	TMC16-3	3I20UNTM2...	22.0	17.0	
	15/16-1	TMC20-3	3I20UNTM2...	43.0	20.0	
	1 1/16-1 1/8	TMLC25-3	3I20UNTM2...	25.0	22.0	
	1 3/16-1 5/16	TM2C25-3	3I20UNTM2...	43.0	26.0	
	1 3/8-1 5/8	TMC25-5	5I20UNTM2...	52.0	30.0	
	1 11/16-1 13/16	TMC32-5	5I20UNTM2...	58.0	37.0	
	1 7/8-2 1/8	TM2C32-5	5I20UNTM2...	45.0	42.0	
18	2 1/4-2 5/8	TMSH-D50-22-3	3I20UNTM2...		50.0	0.81
	2 3/4-3	TMSH-D63-22-5	5I20UNTM2...		63.0	
	9/16	TMC12-2	2I18UNTM...028/017	12.0	11.5	
	5/8	TMC12-2	2I18UNTM2...	12.0	11.5	
	1 1/16-1 3/16	TMLC25-3	3I18UNTM2...	25.0	22.0	
	1 1/4-1 3/8	TM2C25-3	3I18UNTM2...	43.0	26.0	
	1 7/16-1 5/8	TMC25-5	5I18UNTM2...	52.0	30.0	
	1 11/16	TMC32-5	5I18UNTM2...	58.0	37.0	
16	7/16-5/8	TMMC12-6.0	6.0I16UNTM...028/014	12.0	9.0	0.92
	11/16-13/16	TMC12-2	2I16UNTM2...	12.0	11.5	
	7/8-15/16	TMC16-3	3I16UNTM2...	22.0	17.0	
	1	TMC20-3	3I16UNTM2...	43.0	20.0	
	1 1/16-1 3/16	TMLC25-3	3I16UNTM2...	25.0	22.0	
	1 1/4-1 3/8	TM2C25-3	3I16UNTM2...	43.0	26.0	
	1 7/16-1 5/8	TMC25-5	5I16UNTM2...	52.0	30.0	
	1 11/16-1 7/8	TMC32-5	5I16UNTM2...	58.0	37.0	
	1 15/16-2 3/16	TM2C32-5	5I16UNTM2...	45.0	42.0	
	2 1/4-2 5/8	TMSH-D50-22-3	3I16UNTM2...		50.0	
2 3/4-3 3/8	TMSH-D63-22-5	5I16UN TM2...		63.0		

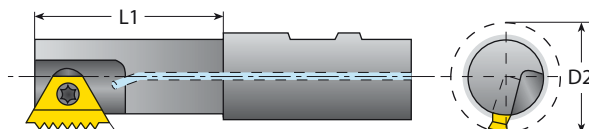

* Die Halterempfehlung ist für die grösste der gegebenen Gewindespezifikationen.

Ein Halter für kleinere oder gleiche Durchmesser (D2) kann ebenfalls benutzt werden. siehe Seite 197

Werkzeugempfehlung für Standardsystem (Fortsetzung)*

(MiTM Werkzeuge auf Seite 254)

(TMSD Werkzeuge auf Seite 268)

(TM Vollhartmetall-Werkzeuge auf Seite 278)

Downloads der TM Gen
Software und Updates
unter www.vargus.de



UN - Innen (Fortsetzung)

Teilung G/Z	Nenndurchmesser Zoll	Halter	Wendeplatte	L1- Schaft Ausraglänge	D2- Werkzeug Fräser Ø*	hmin. Gewindeprofiltiefe		
16	3 1/2-4	TMSH-D80-27-5	5I16UNTM2...		80.0	0.92		
14	7/16	TMMC20-6.0 124/003	6.0I14UNTM...028/013	15.0	9.0	1.05		
	7/8	TMC12-2	2I14UNTM2...	12.0	11.5			
13	1/2	TMC20-2 124/005	2I13UNTM...028/015	15.5	10.0	1.13		
	9/16-11/16	TMC20-2 124/005	2I12UNTM...028/016	15.5	10.0			
	3/4	TMNC16-3	3I12UNTM...028/020	22.0	15.5			
	13/16	TMC16-3	3I12UNTM...028/020	22.0	17.0			
	7/8	TMNC16-3	3I12UNTM2...	22.0	15.5			
	15/16	TMC16-3	3I12UNTM2...	22.0	17.0			
	1	BTMC20-3B	3B12UNTM2...	29.0	19.0			
	1 1/16	TMC20-3	3I12UNTM2...	43.0	20.0			
	12	1 1/8-1 1/4	TMLC25-3	3I12UNTM2...	25.0		22.0	1.22
		1 5/16-1 7/16	TM2C25-3	3I12UNTM2...	43.0		26.0	
1 1/2-1 11/16		TMC25-5	5I12UNTM2...	52.0	30.0			
1 3/4-1 15/16		TMC32-5	5I12UNTM2...	58.0	37.0			
2-2 1/4		TM2C32-5	5I12UNTM2...	45.0	42.0			
2 3/8-2 3/4		TMSH-D50-22-3	3I12UNTM2...		50.0			
2 7/8-3 3/8		TMSH-D63-22-5	5I12UNTM2...		63.0			
3 1/2-4		TMSH-D80-27-5	5I12UNTM2...		80.0			
11		5/8	TMC20-2 124/006	2I11UNTM...028/018	15.5	12.0	1.33	
10		3/4	TMC16-3 124/001	3I10UNTM...028/019	20.5	15.5	1.47	
9	7/8	TMC25-4 124/002	4I9UNTM...028/021	30.0	18.0	1.63		
	1-1 3/16	TMC25-4 124/007	4I8UNTM...028/022	40.0	20.0			
	1 1/4-1 3/8	TMC25-5 124/004	5I8UNTM...028/024	40.0	25.0			
	1 7/16-1 5/8	TMC25-5	5I8UNTM...028/024	52.0	30.0			
	1 11/16-1 15/16	TMC25-5	5I8UNTM2...	52.0	30.0			
	2-2 1/8	TMC32-5	5I8UNTM2...	58.0	37.0			
	2 1/4-2 7/8	TM2C32-5	5I8UNTM2...	45.0	42.0			
	3-3 5/8	TMSH-D63-22-5	5I8UNTM2...		63.0			
	3 3/4-4	TMSH-D80-27-5	5I8UNTM2...		80.0			
7	1 1/8-1 1/4	TMC25-4 124/002	4I7UNTM...028/023	30.0	18.0	2.09		
	1 3/8-1 9/16	TMC25-5 124/004	5I6UNTM...028/025	40.0	25.0			
	1 5/8-1 15/16	TMC25-5	5I6UNTM...028/025	52.0	30.0			
	2-2 1/8	TMC25-5	5I6UNTM2...	52.0	30.0			
	2 1/4	TMC32-5	5I6UNTM2...	58.0	37.0			
6	2 3/8-2 1/2	TMC40-6B	6B16UNTM2...	65.0	46.0	2.44		
	2 5/8-3 1/8	TM2C40-6B	6B16UNTM2...	65.0	52.0			
	3 1/4-3 3/4	TMSH-D63-22-6B	6B16UNTM2...		63.0			
	3 7/8-4	TMSH-D80-27-6B	6B16UNTM2...		80.0			
	5	1 3/4	TMC25-5	5I5UNTM...028/077	52.0		30.0	2.93
4.5	2-2 1/4	TMC32-6B	6B14.5UNTM2...	55.0	35.0	3.26		
	2 1/2	TMC40-6B	6B14UNTM2...	65.0	46.0			
4	2 3/4-3	TM2C40-6B	6B14UNTM2...	65.0	52.0	3.67		
	3 1/4-4	TMSH-D63-22-6B	6B14UNTM2...		63.0			

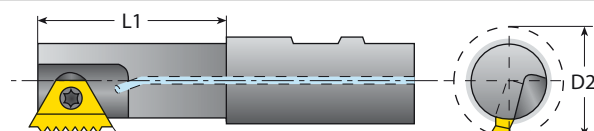

* Die Halterempfehlung ist für die grösste der gegebenen Gewindespezifikationen.
Ein Halter für kleinere oder gleiche Durchmesser (D2) kann ebenfalls benutzt werden (außer Schneidplatten 028/...)

Werkzeugempfehlung (Fortsetzung)*

(MiTM Werkzeuge auf Seite 254)

(TMSD Werkzeuge auf Seite 268)

(TM Vollhartmetall-Werkzeuge auf Seite 278)

Downloads der TM Gen
Software und Updates
unter www.vargus.de



UNJ - Innen

Teilung	Nenndurchmesser	Halter	Wendeplatte	L1- Schaft	D2- Werkzeug	hmin.
G/Z	Zoll			Auskraglänge	Fräser Ø*	Gewindeprofiltiefe
24	9/16-11/16	TMC12-2	2I24UNJTM2...	12.0	11.5	0.55
20	1/2	TMMC12-6.0	6.0I20UNJTM...	12.0	9.0	0.66
	3/4-13/16	TMC12-2	2I20UNJTM2...	12.0	11.5	
	7/8	TMC16-3	3I20UNJTM2...	22.0	17.0	
	15/16-1	TMC20-3	3I20UNJTM2...	43.0	20.0	
18	5/8	TMC12-2	2I18UNJTM2...	12.0	11.5	0.74
	1 1/16-1 3/16	TMLC25-3	3I18UNJTM2...	25.0	22.0	
	1 1/4-1 11/16	TM2C25-3	3I18UNJTM2...	43.0	26.0	
16	11/16-13/16	TMC12-2	2I16UNJTM2...	12.0	11.5	0.83
	7/8-15/16	TMC16-3	3I16UNJTM2...	22.0	17.0	
	1	TMC20-3	3I16UNJTM2...	43.0	20.0	
	1 1/16-1 3/16	TMLC25-3	3I16UNJTM2...	25.0	22.0	
	1 1/4-1 3/8	TM2C25-3	3I16UNJTM2...	43.0	26.0	
	1 7/16-1 5/8	TMC25-5	5I16UNJTM2...	52.0	30.0	
	1 11/16-1 7/8	TMC32-5	5I16UNJTM2...	58.0	37.0	
	1 15/16-2 1/8	TM2C32-5	5I16UNJTM2...	45.0	42.0	
14	2 1/4-2 3/8	TMSH-D50-22-3	3I16UNJTM2...		50.0	0.95
	7/8	TMC12-2	2I14UNJTM2...	12.0	11.5	
	7/8	TMNC16-3	3I12UNJTM2...	22.0	15.5	
	15/16-1	TMC16-3	3I12UNJTM2...	22.0	17.0	
	1 1/16	TMC20-3	3I12UNJTM2...	43.0	20.0	
	1 1/8-1 1/4	TMLC25-3	3I12UNJTM2...	25.0	22.0	
	1 5/16-1 7/16	TM2C25-3	3I12UNJTM2...	43.0	26.0	
	1 1/2-1 11/16	TMC25-5	5I12UNJTM2...	52.0	30.0	
12	1 3/4-1 15/16	TMC32-5	5I12UNJTM2...	58.0	37.0	1.11
	2-2 1/4	TM2C32-5	5I12UNJTM2...	45.0	42.0	
	2 3/8-2 3/4	TMSH-D50-22-3	3I12UNJTM2...		50.0	
	2 7/8-3 3/8	TMSH-D63-22-5	5I12UNJTM2...		63.0	
	3 1/2-4 1/4	TMSH-D80-27-5	5I12UNJTM2...		80.0	
	4 3/8-5 1/4	TMSH-D100-32-5	5I12UNJTM2...		100.0	
	5 3/8-6	TMSH-D125-40-5	5I12UNJTM2...		125.0	

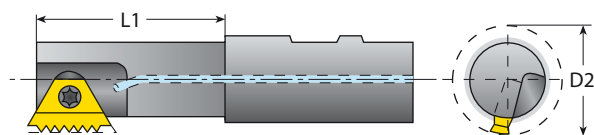

* Die Halterempfehlung ist für die grösste der gegebenen Gewindespezifikationen.

Ein Halter für kleinere oder gleiche Durchmesser (D2) kann ebenfalls benutzt werden (außer Schneidplatten 028/...)

Werkzeugempfehlung (Fortsetzung)*

(MiTM Werkzeuge auf Seite 254)

(TMSD Werkzeuge auf Seite 268)

(TM Vollhartmetall-Werkzeuge auf Seite 278)

Downloads der TM Gen
Software und Updates
unter www.vargus.de



W - Innen

Teilung G/Z	Nenndurchmesser Zoll	Halter	Wendeplatte	L1- Schaft Auskräglänge	D2- Werkzeug Fräser Ø*	hmin. Gewindeprofiltiefe
26	7/16	TMMC12-6.0	6.0I26WTM...028/036	12.0	9.0	0.63
	1/2-9/16	TMMC12-6.0	6.0E126WTM...	12.0	9.0	
	5/8-3/4	TMC12-2	2E126WTM2...	12.0	11.5	
	13/16-7/8	TMC16-3	3E126WTM2...	22.0	17.0	
	15/16-1	TMC20-3	3E126WTM2...	43.0	20.0	
	1 1/16-1 1/8	TMLC25-3	3E126WTM2...	25.0	22.0	
	1 3/16-1 5/8	TM2C25-3	3E126WTM2...	43.0	26.0	
	1 3/4-2	TMSH-D38-16-2	2E126WTM2...		38.0	
20	1/2	TMMC12-6.0	6.0I20WTM...028/037	12.0	9.0	0.81
	9/16	TMMC12-6.0	6.0E120WTM2...	12.0	9.0	
	5/8-13/16	TMC12-2	2E120WTM2...	12.0	11.5	
	7/8-15/16	TMC16-3	3E120WTM2...	22.0	17.0	
	1	TMC20-3	3E120WTM2...	43.0	20.0	
	1 1/16-1 3/16	TMLC25-3	3E120WTM2...	25.0	22.0	
	1 1/4-1 5/8	TM2C25-3	3E120WTM2...	43.0	26.0	
	1 3/4-2 1/8	TMSH-D38-16-2	2E120WTM2...		38.0	
18	2 1/4-3	TMSH-D50-22-3	3E120WTM2...		50.0	0.90
	7/16	TMMC12-6.0	6.0I18WTM...028/035	12.0	9.0	
	1/2	TMC20-2 124/005	2I16WTM...028/051	15.5	10.0	
	9/16-3/4	TMC12-2	2I16WTM...028/038	12.0	11.5	
	13/16	TMNC16-3	3E116WTM2...	22.0	15.5	
	7/8-15/16	TMC16-3	3E116WTM2...	22.0	17.0	
	1-1 1/16	TMC20-3	3E116WTM2...	43.0	20.0	
	1 1/8-1 1/4	TMLC25-3	3E116WTM2...	25.0	22.0	
16	1 5/16-1 3/8	TM2C25-3	3E116WTM2...	43.0	26.0	1.02
	1.4-1 5/8	TMC25-5	5E116WTM2...	52.0	30.0	
	1 3/4-1.9	TMC32-5	5E116WTM2...	58.0	37.0	
	2-2 1/4	TM2C32-5	5E116WTM2...	45.0	42.0	
	2 3/8-2 3/4	TMSH-D50-22-3	3E116WTM2...		50.0	
	2 7/8-3 3/8	TMSH-D63-22-5	5E116WTM2...		63.0	
	3 1/2-4 1/8	TMSH-D80-27-5	5E116WTM2...		80.0	
	4 1/4-5 1/8	TMSH-D100-32-5	5E116WTM2...		100.0	
	5 1/4-7	TMSH-D125-40-5	5E116WTM2...		125.0	
	5 1/2-7 1/2	TMSH-D150-50-5	5E116WTM2...		150.0	
14	5/8-11/16	TMC20-2 124/006	2I14WTM...028/039	15.5	12.0	1.16
	3/4	TMC16-3 124/001	3I12WTM...028/040	20.5	15.5	
	13/16	TMC16-3	3I12WTM...028/041	22.0	17.0	
12	15/16-1 5/16	TMC20-3	3I12WTM...028/041	43.0	20.0	1.36
	1 3/8-1 7/16	TMC25-5	5I12WTM...028/050	52.0	30.0	
	1 1/2-1 3/4	TMC25-5	5E112WTM2...	52.0	30.0	
	1 7/8	TMC32-5	5E112WTM2...	58.0	37.0	
	2-2 1/4	TM2C32-5	5E112WTM2...	45.0	42.0	

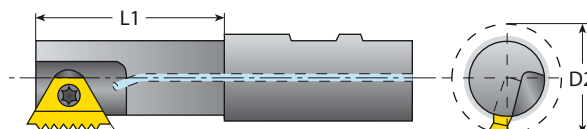

* Die Halterempfehlung ist für die grösste der gegebenen Gewindespezifikationen.
Ein Halter für kleinere oder gleiche Durchmesser (D2) kann ebenfalls benutzt werden (außer Schneidplatten 028/...)

Werkzeugempfehlung (Fortsetzung)*

(MiTM Werkzeuge auf Seite 254)

(TMSD Werkzeuge auf Seite 268)

(TM Vollhartmetall-Werkzeuge auf Seite 278)

Downloads der TM Gen
Software und Updates
unter www.vargus.de



W - Innen (Fortsetzung)

Teilung	Nenndurchmesser	Halter	Wendeplatte	L1- Schaft	D2- Werkzeug	hmin. -
G/Z	Zoll			Auskräglänge	Fräser Ø*	Gewindeprofiltiefe
12	2 3/8 -2 3/4	TMSH-D50-22-3	3E12WTM2...		50.0	1.36
	2 7/8-3 3/8	TMSH-D63-22-5	5E12WTM2...		63.0	
	3 1/2-4 1/8	TMSH-D80-27-5	5E12WTM2...		80.0	
	4 1/4-5 1/8	TMSH-D100-32-5	5E12WTM2...		100.0	
	5 1/4-7	TMSH-D125-40-5	5E12WTM2...		125.0	
11	7/8	TMC25-4 124/002	4I11WTM...028/043	30.0	18.0	1.48
10	1	TMC25-4 124/002	4I10WTM...028/045	30.0	18.0	1.63
8	7/8-1 1/4	TMC25-4 124/002	4I9WTM...028/042	30.0	18.0	2.03
	1	TMC25-4 124/002	4I8WTM...028/044	30.0	18.0	
	1 3/16-1.4	TMC25-5 124/004	5I8WTM...028/047	40.0	25.0	
	1 7/16-1 5/8	TMC25-5	5I8WTM...028/047	52.0	30.0	
	1 7/8-1.9	TMC25-5	5E18WTM2...	52.0	30.0	
	2.1-2 1/8	TMC32-5	5E18WTM2...	58.0	37.0	
	2 1/4-3	TM2C32-5	5E18WTM2...	45.0	42.0	
	3 1/8-3 5/8	TMSH-D63-22-5	5E18WTM2...		63.0	
	3 3/4-4 3/8	TMSH-D80-27-5	5E18WTM2...		80.0	
	4 5/8-5 1/2	TMSH-D100-32-5	5E18WTM2...		100.0	
7	5 5/8-7	TMSH-D125-40-5	5E18WTM2...		125.0	2.32
	1 1/8	TMC25-5 124/008	5I7WTM...028/046	40.0	22.0	
	1 1/4	TMC25-5 124/004	5I7WTM...028/048	40.0	25.0	
	1 3/4	TMC25-5	5I7WTM...028/048	52.0	30.0	
	2	TMC25-5	5E17WTM2...	52.0	30.0	
6	1 5/16-1 1/2	TMC25-5 124/004	5I6WTM...028/049	40.0	25.0	2.71
	1.6-1 5/8	TMC25-5	5I6WTM...028/049	52.0	30.0	
	1 7/8-1.9	TMC32-5	5I6WTM...028/049	58.0	37.0	
	2.1-2 1/8	TMC25-5	5E16WTM2...	52.0	30.0	
	2 1/4	TMC32-6B	6BE16WTM2...	55.0	35.0	
	2 3/8-2.6	TMC32-5	5E16WTM2...	58.0	37.0	
	2 5/8-2 3/4	TMC40-6B	6BE16WTM2...	65.0	46.0	
	2 7/8-3 1/4	TM2C40-6B	6BE16WTM2...	65.0	52.0	
	3 3/8-3 7/8	TMSH-D63-22-6B	6BE16WTM2...		63.0	
	4-4 3/4	TMSH-D80-27-6B	6BE16WTM2...		80.0	
5	4 7/8-5 3/4	TMSH-D100-32-6B	6BE16WTM2...		100.0	3.25
	5 7/8-7	TMSH-D125-40-6B	6BE16WTM2...		125.0	
	3	TMC40-6B	6BE15WTM2...	65.0	46.0	
	3 1/4	TM2C40-6B	6BE15WTM2...	65.0	52.0	
4.5	3 1/2	TMC40-6B	6BE14.5WTM2...	65.0	46.0	3.61
	3 3/4-4	TM2C40-6B	6BE14.5WTM2...	65.0	52.0	

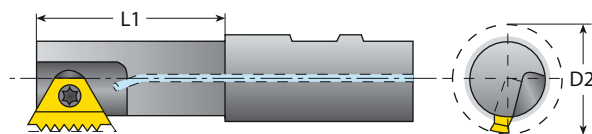

* Die Halterempfehlung ist für die grösste der gegebenen Gewindespezifikationen.

Ein Halter für kleinere oder gleiche Durchmesser (D2) kann ebenfalls benutzt werden (außer Schneidplatten 028/...)

Werkzeugempfehlung (Fortsetzung)*

(MiTM Werkzeuge auf Seite 254)

(TMSD Werkzeuge auf Seite 268)

(TM Vollhartmetall-Werkzeuge auf Seite 278)

Downloads der TM Gen
Software und Updates
unter www.vargus.de



BSP - Innen

Teilung G/Z	Nenndurchmesser Zoll	Halter	Wendeplatte	L1- Schaft Ausraglänge	D2- Werkzeug Fräser Ø*	hmin. - Gewindeprofiltiefe
19	1/4	TMMC20-6.0	6.0EI19WTM...	17.0	9.0	0.86
	3/8	TMC20-2	2EI19WTM2...	20.0	11.5	
14	1/2-5/8	TMC20-2	2EI14WTM2...	20.0	11.5	1.16
	3/4-7/8	TMC16-3	3EI14WTM2...	22.0	17.0	
11	1	TMC25-5 124/004	5EI11WTM2...	40.0	25.0	1.48
	1 1/4-1 1/2	TMC25-5	5EI11WTM2...	52.0	30.0	
	1 3/4	TMC32-5	5EI11WTM2...	58.0	37.0	
	2-2 1/4	TM2C32-5	5EI11WTM2...	45.0	42.0	
	2 1/2-3	TMSH-D63-22-5	5EI11WTM2...		63.0	
	3 1/2	TMSH-D80-27-5	5EI11WTM2...		80.0	
	4	TMSH-D100-32-5	5EI11WTM2...		100.0	
5-6	TMSH-D125-40-5	5EI11WTM2...		125.0		

BSPT - Innen

Teilung G/Z	Nenndurchmesser Zoll	Halter	Wendeplatte	L1- Schaft Ausraglänge	D2- Werkzeug Fräser Ø*	hmin. - Gewindeprofiltiefe
19	3/8	TMC20-2	2EI19BSPTTM...	20.0	11.5	0.86
14	1/2-3/4	TMNC16-3	3EI14BSPTTM...	22.0	15.5	1.16
11	1-1 1/4	TMNC20-3	3EI11BSPTTM...	23.0	19.0	1.48
	1 1/2	TMC25-5	5EI11BSPTTM...	52.0	30.0	
	2-6	TMNC32-5	5EI11BSPTTM...	58.0	37.0	

NPT - Innen

Teilung G/Z	Nenndurchmesser Zoll	Halter	Wendeplatte	L1- Schaft Ausraglänge	D2- Werkzeug Fräser Ø*	hmin. - Gewindeprofiltiefe
18	1/4-3/8	TMC20-2 124/009	2I18NPTTM...028/074	15.5	10.0	1.01
14	1/2	TMNC16-3	3EI14NPTTM...	22.0	15.5	1.33
	3/4	TMNC20-3	3EI14NPTTM...	23.0	19.0	
11.5	1	TMNC20-3	3EI11.5NPTTM...	23.0	19.0	1.64
	1 1/4	TMC25-5	5EI11.5NPTTM...	52.0	30.0	
	1 1/2-2	TMNC32-5	5EI11.5NPTTM...	58.0	37.0	
8	2 1/2	TMNC32-5	5EI8NPTTM...	58.0	37.0	2.42
	3-24	TMC40-6B	6BEI8NPTTM...	65.0	46.0	

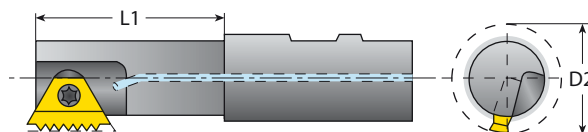

* Die Halterempfehlung ist für die grösste der gegebenen Gewindefspezifikationen.
Ein Halter für kleinere oder gleiche Durchmesser (D2) kann ebenfalls benutzt werden (außer Schneidplatten 028/...)

Werkzeugempfehlung (Fortsetzung)*

(MiTM Werkzeuge auf Seite 254)

(TMSD Werkzeuge auf Seite 268)

(TM Vollhartmetall-Werkzeuge auf Seite 278)

Downloads der TM Gen
Software und Updates
unter www.vargus.de



NPTF - Innen

Teilung	Nenndurchmesser	Halter	Wendeplatte	L1- Schaft	D2- Werkzeug	hmin. - Gewindeprofiltiefe
G/Z	Zoll			Auskräglänge	Fräser Ø*	
18	1/4-3/8	TMC20-2 124/009	2I18NPTFTM...028/078	15.5	10.0	1.00
14	1/2	TMNC16-3	3EI14NPTFTM...	22.0	15.5	1.35
	3/4	TMNC20-3	3EI14NPTFTM...	23.0	19.0	
11.5	1	TMNC20-3	3EI11.5NPTFTM...	23.0	19.0	1.63
	1 1/4	TMC25-5 124/004	5EI11.5NPTFTM...	40.0	25.0	
	1 1/2	TMC25-5	5EI11.5NPTFTM...	52.0	30.0	
	2	TMNC32-5	5EI11.5NPTFTM...	58.0	37.0	
8	2 1/2	TMNC32-5	5EI8NPTFTM...	58.0	37.0	2.38
	3	TMC40-6B	6BEI8NPTFTM...	65.0	46.0	

PG - Innen

Teilung	Nenndurchmesser	Halter	Wendeplatte	L1- Schaft	D2- Werkzeug	hmin. - Gewindeprofiltiefe
G/Z	Zoll			Auskräglänge	Fräser Ø*	
20	PG7	TMMC12-6.0	6.0EI20PGTM...	12.0	9.0	0.61
18	PG9	TMC12-2	2EI18PGTM2...	12.0	11.5	0.67
	PG11	TMNC16-3	3EI18PGTM2...	22.0	15.5	
	PG13.5	TMC16-3	3EI18PGTM2...	22.0	17.0	
	PG16	TMC20-3	3EI18PGTM2...	43.0	20.0	
16	PG21	TMC25-5 124/004	5EI16PGTM2...	40.0	25.0	0.76
	PG29	TMC25-5	5EI16PGTM2...	52.0	30.0	
	PG36	TM2C32-5	5EI16PGTM2...	45.0	42.0	
	PG42-PG48	TMSH-D50-22-3	3EI16PGTM2...		50.0	

TR -Innen

Teilung	Nenndurchmesser	Halter	Wendeplatte	L1- Schaft	D2- Werkzeug	hmin. - Gewindeprofiltiefe
mm	Zoll			Auskräglänge	Fräser Ø*	
2.0	TR16	TMC20-2 124/006	2I2.0TRTM...028/028	15.5	12.0	1.25
	TR18-TR20	TMC20-2 124/006	2I2.0TRTM...028/029	15.5	12.0	
3.0	TR24	TMC25-4 124/002	4I3.0TRTM...028/030	30.0	18.0	1.75
	TR26-TR30	TMC25-4 124/002	4I3.0TRTM...028/031	30.0	18.0	
	TR32-TR36	TMC25-4 124/007	4I3.0TRTM...028/032	40.0	20.0	
	TR38-TR42	TMC25-5 124/004	5I3.0TRTM...028/033	40.0	25.0	
	TR44-TR48	TMC25-5	5I3.0TRTM...028/033	52.0	30.0	
	TR50-TR60	TMC32-5	5I3.0TRTM...028/033	58.0	37.0	
4.0	TR65-TR110	TMC32-5	5I4.0TRTM...028/034	58.0	37.0	2.25

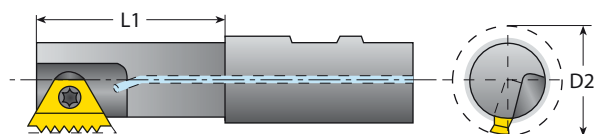

* Die Halterempfehlung ist für die grösste der gegebenen Gewindespezifikationen.

Ein Halter für kleinere oder gleiche Durchmesser (D2) kann ebenfalls benutzt werden (außer Schneidplatten 028/...)

Werkzeugempfehlung (Fortsetzung)*

(MitM Werkzeuge auf Seite 254)

(TMSD Werkzeuge auf Seite 268)

(TM Vollhartmetall-Werkzeuge auf Seite 278)

Downloads der TM Gen
Software und Updates
unter www.vargus.de



ACME - Innen

Teilung G/Z	Nenndurchmesser Zoll	Halter	Wendeplatte	L1- Schaft Auskräglänge	D2- Werkzeug Fräser Ø*	hmin. - Gewindeprofiltiefe
16	1/2	TMMC12-6.0	6.0116ACMETM...028/052	12.0	9.0	0.92
	5/8	TMC12-2	2116ACMETM...028/053	12.0	11.5	
	3/4	TMC12-2	2116ACMETM...028/055	12.0	11.5	
14	5/8	TMC20-2 124/005	2114ACMETM...028/054	15.5	10.0	1.03
	3/4	TMC20-2 124/006	2114ACMETM...028/083	15.5	12.0	
	7/8	TMNC16-3	3114ACMETM...028/057	22.0	15.5	
	1	TMC16-3	3114ACMETM...028/059	22.0	17.0	
12	3/4	TMC20-2 124/006	2112ACMETM...028/056	15.5	12.0	1.19
	7/8	TMC20-2 124/006	2112ACMETM...028/058	15.5	12.0	
	1	TMNC16-3	3112ACMETM...028/060	22.0	15.5	
	1 1/8	TMC16-3	3112ACMETM...028/060	22.0	17.0	
	1 1/4	TMC20-3	3112ACMETM...028/060	43.0	20.0	
10	1	TMC25-4 124/002	4110ACMETM...028/061	30.0	18.0	1.52
	1 1/8	TMC25-4 124/007	4110ACMETM...028/084	40.0	20.0	
	1 1/4	TMC25-5 124/004	5110ACMETM...028/064	40.0	25.0	
	1 3/8	TMC25-5 124/004	5110ACMETM...028/065	40.0	25.0	
	1 1/2	TMC25-5	5110ACMETM...028/068	52.0	30.0	
	1 3/4	TMC32-5	5110ACMETM...028/064	58.0	37.0	
8	1	TMC25-4 124/002	418ACMETM...028/062	30.0	18.0	1.84
	1 1/8-1 1/4	TMC25-4 124/002	418ACMETM...028/063	30.0	18.0	
	1 3/8	TMC25-5 124/004	518ACMETM...028/066	40.0	25.0	
	1 1/2	TMC25-5 124/004	518ACMETM...028/069	40.0	25.0	
	1 3/4	TMC25-5	518ACMETM...028/069	52.0	30.0	
	2	TMC32-5	518ACMETM...028/069	58.0	37.0	
6	1 3/8	TMC25-5 124/008	516ACMETM...028/067	40.0	22.0	2.37
	1 1/2	TMC25-5 124/004	516ACMETM...028/070	40.0	25.0	
	1 3/4	TMC25-5	516ACMETM...028/070	52.0	30.0	
	2	TMC25-5	516ACMETM...028/072	52.0	30.0	
	2 1/4	TMC32-5	516ACMETM...028/072	58.0	37.0	
5	1 3/4	TMC25-5 124/004	515ACMETM...028/071	40.0	25.0	2.79
	2	TMC25-5	515ACMETM...028/071	52.0	30.0	
	2 1/4	TMC25-5	515ACMETM...028/073	52.0	30.0	
	2 1/2	TMC32-5	515ACMETM...028/073	58.0	37.0	

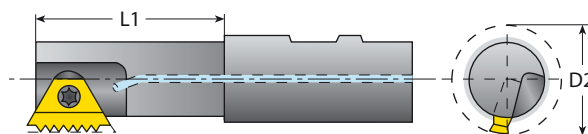

* Die Halterempfehlung ist für die grösste der gegebenen Gewindefspezifikationen.

Ein Halter für kleinere oder gleiche Durchmesser (D2) kann ebenfalls benutzt werden (außer Schneidplatten 028/...)



Gewindefräsen



> Standard-
schneidplatten

INHALTSVERZEICHNIS GEWINDEFRÄSPLATTEN

■ Vardex Bestellnummernsystem.....	Seite 208
■ ISO metrisch Standard TM Wendeplatten.....	Seite 209
■ ISO metrisch TM Wendeplatten für Innenregelgewinde.....	Seite 211
■ ISO metrisch TM Wendeplatten für TMO- Fräser.....	Seite 212
■ ISO metrisch TM Wendeplatten für feine Teilungen.....	Seite 213
■ American UN Standard TM Wendeplatten.....	Seite 214
■ American UN TM Wendeplatten für Innenregelgewinde.....	Seite 216
■ American UN TM Wendeplatten für TMO- Fräser.....	Seite 218
■ American UN TM Wendeplatten für feine Teilungen.....	Seite 220
■ UNJ Standard TM Wendeplatten.....	Seite 221
■ W für BSW, BSP (G) Standard TM Wendeplatten.....	Seite 222
■ W für BSW TM Wendeplatten nur für Innenregelgewinde.....	Seite 223
■ W für BSW, BSP TM Wendeplatten für TMO- Fräser.....	Seite 225
■ NPT Standard TM Wendeplatten.....	Seite 226
■ NPT TM Wendeplatten für Innenregelgewinde.....	Seite 226
■ NPTF (Dry Seal) Standard TM Wendeplatten.....	Seite 227
■ NPTF (Dry Seal) TM Wendeplatten für Innenregelgewinde.....	Seite 227
■ NPS Standard TM Wendeplatten.....	Seite 228
■ BSPT Standard TM Wendeplatten.....	Seite 228
■ Pg Standard TM Wendeplatten.....	Seite 229
■ ACME TM Wendeplatten für Innenregelgewinde.....	Seite 230
■ TR TM Wendeplatten für Innenregelgewinde.....	Seite 231

Vardex Bestellnummernsystem

Gewindefräsplatten

3	B	I	1.5	ISO	TM2	F	VBX	028/...
1	2	3	4	5	6	7	8	9

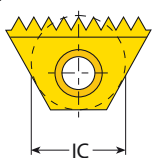
1 - Plattengröße 6.0 - 6.0 mm 2 - 1/4" 3 - 3/8" 3B - 3/8"B 4 - 1/2" 5 - 5/8" 6B - 3/4"B		2 - Schneidkantenlänge B - TMB breite Version	3 - Platte E - Außen I - Innen EI - Aussen + Innen	4 - Teilung 0.35 - 6.0
---	---	---	--	----------------------------------

5 - Norm ISO- ISO Metrisch UN- Amerikanisch UN UNJ- UNJ W- Whitworth für BSW, BSP NPT - NPT NPTF- NPTF NPS- NPS	BSPT- DIN EN 10226-1. PG- Pg DIN 40430 ACME- ACME TR- Trapez DIN 103	6 - System TM2 TM	8 - Hartmetallsorte VBX VTX VK2
---	---	--------------------------------	---

7 - Teilung F = Feine Teilung	9 - Platten für Innenregelgewinde 028/...
---	---

ISO metrisch

Außen / Innen

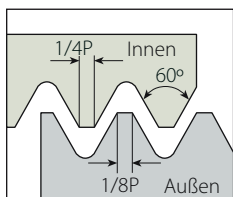

Norm: R262 (DIN 13)
 Toleranzklasse: 6g/6H

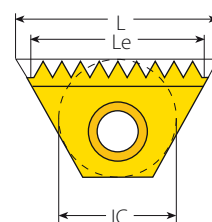

Standard TM

Standard TM

Plattengröße		Teilung	Bestellnummer		Le	Zähne	Trägerkörper
IC	L mm	mm	Außen	Innen	mm		
6.0mm	10.4	0.5		6.0I0.5ISOTM...	10.0	20	TMMC...-6.0
		0.75		6.0I0.75ISOTM...	9.75	13	
		1.0		6.0I1.0ISOTM...	9.0	9	
		1.25		6.0I1.25ISOTM...	8.75	7	
		1.5		6.0I1.5ISOTM...	9.0	6	
1/4"	11	0.5		2I0.5ISOTM2...	10.0	20	TMC...-2 TMSH...-2
		0.75	2E0.75ISOTM2...	2I0.75ISOTM2...	10.5	14	
		1.0	2E1.0ISOTM2...	2I1.0ISOTM2...	10.0	10	
		1.25	2E1.25ISOTM2...			8	
		1.25		2I1.25ISOTM2...	8.75	7	
		1.5	2E1.5ISOTM2...			6	
		1.5		2I1.5ISOTM2...	10.5	7	
3/8"	16	0.5		3I0.5ISOTM2...	15.0	30	TMC...-3 TMSH...-3
		0.75	3E0.75ISOTM2...	3I0.75ISOTM2...	15.0	20	
		0.8		3I0.8ISOTM2...	14.4	18	
		1.0	3E1.0ISOTM2...			14	
		1.0		3I1.0ISOTM2...	15.0	15	
		1.25	3E1.25ISOTM2...	3I1.25ISOTM2...	15.0	12	
		1.5	3E1.5ISOTM2...	3I1.5ISOTM2...	15.0	10	
		1.75	3E1.75ISOTM2...	3I1.75ISOTM2...	14.0	8	
		2.0	3E2.0ISOTM2...	3I2.0ISOTM2...	14.0	7	
3/8"B	22	1.0	3BE1.0ISOTM2...	3BI1.0ISOTM2...	22.0	22	BTMC...-3B TMSH...-3B
		1.25	3BE1.25ISOTM2...	3BI1.25ISOTM2...	21.25	17	
		1.5	3BE1.5ISOTM2...	3BI1.5ISOTM2...	21.0	14	
		1.75	3BE1.75ISOTM2...	3BI1.75ISOTM2...	21.0	12	
		2.0	3BE2.0ISOTM2...	3BI2.0ISOTM2...	22.0	11	
5/8"	27	1.0	5E1.0ISOTM2...	5I1.0ISOTM2...	26.0	26	TMC...-5 TMSH...-5
		1.25	5E1.25ISOTM2...	5I1.25ISOTM2...	25.0	20	
		1.5	5E1.5ISOTM2...	5I1.5ISOTM2...	25.5	17	
		1.75	5E1.75ISOTM2...	5I1.75ISOTM2...	24.5	14	
		2.0	5E2.0ISOTM2...	5I2.0ISOTM2...	24.0	12	
		2.5	5E2.5ISOTM2...	5I2.5ISOTM2...	25.0	10	
		3.0	5E3.0ISOTM2...	5I3.0ISOTM2...	24.0	8	
		3.5	5E3.5ISOTM2...	5I3.5ISOTM2...	24.5	7	
		4.0	5E4.0ISOTM2...	5I4.0ISOTM2...	24.0	6	
		4.5	5E4.5ISOTM2...	5I4.5ISOTM2...	22.5	5	

Fortsetzung nächste Seite ►

ISO metrisch (Fortsetzung)

Außen / Innen

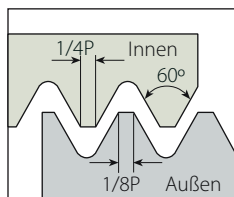

Norm: R262 (DIN 13)
Toleranzklasse: 6g/6H

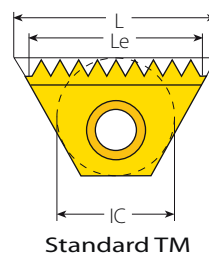

Standard TM

Standard TM(Fortsetzung)

Plattengröße		Teilung		Bestellnummer		Le	Zähne	Trägerkörper
IC	L mm	mm	Außen	Innen	mm			
3/4"B	38,5	1.5	6BE1.5ISOTM2...	6BI1.5ISOTM2...	36.0	24	TMC..-6B TMSH..-6B	
		2.0	6BE2.0ISOTM2...	6BI2.0ISOTM2...	36.0	18		
		2.5	6BE2.5ISOTM2...	6BI2.5ISOTM2...	35.0	14		
		3.0	6BE3.0ISOTM2...	6BI3.0ISOTM2...	36.0	12		
		4.0	6BE4.0ISOTM2...	6BI4.0ISOTM2...	32.0	8		
		4.5	6BE4.5ISOTM2...	6BI4.5ISOTM2...	31.5	7		
		5.0	6BE5.0ISOTM2...	6BI5.0ISOTM2...	30.0	6		
		5.5	6BE5.5ISOTM2...	6BI5.5ISOTM2...	33.0	6		
		6.0	6BE6.0ISOTM2...	6BI6.0ISOTM2...	30.0	5		

Bestellbeispiel: **5I2.0ISOTM2 VBX**

Alle Platten besitzen zwei Schneidkanten, außer **MiniTM (IC 6.0 mm)** mit einer Schneidkante.

Informationen zu Trägerkörpern auf Seite 234.

ISO metrisch (Fortsetzung)

Innen

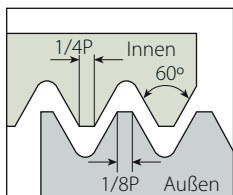

Norm: R262 (DIN 13)
 Toleranzklasse: 6g/6H

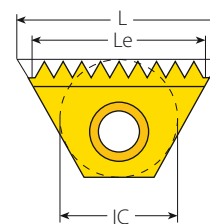

Regelgewinde TM

Regelgewinde TM

Gewinde	Plattengröße		Bestellnummer	Schneidkante	Le	Zähne	Trägerkörper	Bohrungsdurchmesserbereich
	IC	L mm						
M10 X 0.75	6.0 mm	10.4	6.010.75ISOTM...028/001	1	9.75	13	TMMC12-6.0	9.1-10
M10 X 0.75	6.0 mm	10.4	6.010.75ISOTM...028/001	1	9.75	13	TMMC20-6.0	9.1-10
M12 X 1.25	6.0 mm	10.4	6.011.25ISOTM...028/002	1	8.75	7	TMMC12-6.0	10.6-11.4
M12 X 1.25	6.0 mm	10.4	6.011.25ISOTM...028/002	1	8.75	7	TMMC20-6.0	10.6-11.4
M12 X 1.75	6.0 mm	10.4	6.011.75ISOTM...028/003	1	8.75	5	TMMC20-6.0 124/003	10.1-19
M14 X 2.0	1/4"	11	212.0ISOTM...028/004	2	10.0	5	TMC12-2	11.8-19.5
M14 x 2.0	1/4"	11	212.0ISOTM...028/004	2	10.0	5	TMC20-2	11.8-19.5
M16 X 2.0	1/4"	11	212.0ISOTM...028/004	2	10.0	5	TMC12-2	11.8-19.5
M16 X 2.0	1/4"	11	212.0ISOTM...028/004	2	10.0	5	TMC20-2	11.8-19.5
M20 X 2.5	3/8"	16	312.5ISOTM...028/005	1	12.5	5	TMC16-3 124/001	17.2-19.2
M22 X 2.5	1/2"	22	412.5ISOTM...028/006	1	17.5	7	TMC25-4 124/002	19.2-31.6
M24 X 3.0	1/2"	22	413.0ISOTM...028/007	1	18.0	6	TMC25-4 124/002	20.7-32.7
M27 X 3.0	1/2"	22	413.0ISOTM...028/007	1	18.0	6	TMC25-4 124/002	20.7-32.7
M30 X 3.5	5/8"	27	513.5ISOTM...028/008	2	24.5	7	TMC25-5 124/004	26.2-35.9
M33 X 3.5	5/8"	27	513.5ISOTM...028/008	2	24.5	7	TMC25-5 124/004	26.2-35.9
M36 X 3.0	5/8"	27	513.0ISOTM...028/009	2	24.0	8	TMC25-5	32.7-39
M36 X 4.0	5/8"	27	514.0ISOTM...028/010	2	24.0	6	TMC25-5	31.6-38.5
M39 X 3.0	5/8"	27	513.0ISOTM...028/009	2	24.0	8	TMC25-5	32.7-39
M39 X 4.0	5/8"	27	514.0ISOTM...028/010	2	24.0	6	TMC25-5	31.6-38.5
M42 X 4.5	5/8"	27	514.5ISOTM...028/011	2	22.5	5	TMC25-5	37.1-48
M45 X 4.5	5/8"	27	514.5ISOTM...028/011	2	22.5	5	TMC25-5	37.1-48
M48 X 5.0	5/8"	27	515.0ISOTM...028/075	2	20.0	4	TMC25-5	38.9-∞
M52 X 5.0	5/8"	27	515.0ISOTM...028/075	2	20.0	4	TMC25-5	38.9-∞

Beispiel Werkzeuganforderung für Gewinde **M14x2.0**.

Bestellnummer:

Platte: **212.0ISOTMVBX028/004**

Fräseerschaft: **TMC20-2**

Informationen zu Trägerkörper auf Seite 234.

ISO metrisch (Fortsetzung)

Außen / Innen

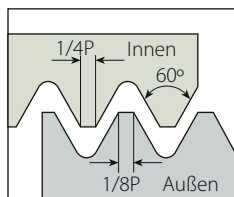

Norm: R262 (DIN 13)
Toleranzklasse: 6g/6H

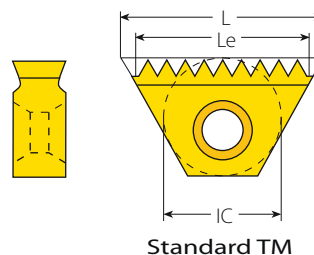

TM Doppelwendeplatten für TMO- Fräser

Plattengröße		Teilung	Bestellnummer		Trägerkörper	ECL
IC	L mm	mm	Außen	Innen	TMO	mm
1/4"	11	0.5		2I0.5ISOTM2...	TMOC20-2-8	19
		0.75	2E0.75ISOTM2...	2I0.75ISOTM2...	TMOC20-2-9	19.5
		1.0	2E1.0ISOTM2...	2I1.0ISOTM2...	TMOC20-2-8	19
		1.25	2E1.25ISOTM2...		TMOC20-2-10	18.75
		1.25		2I1.25ISOTM2...	TMOC20-2-10	16.25
		1.5	2E1.5ISOTM2...		TMOC20-2-8	18
		1.5		2I1.5ISOTM2...	TMOC20-2-8	19.5
3/8"	16	0.5		3I0.5ISOTM2...	TMOC20-3-1	28.5
		0.5		3I0.5ISOTM2...	TMOC20-3-10	29
		0.75	3E0.75ISOTM2...	3I0.75ISOTM2...	TMOC20-3-11	28.5
		1.0	3E1.0ISOTM2...		TMOC20-3-10	28
		1.0		3I1.0ISOTM2...	TMOC20-3-10	29
		1.25	3E1.25ISOTM2...	3I1.25ISOTM2...	TMOC20-3-7	28.75
		1.5	3E1.5ISOTM2...	3I1.5ISOTM2...	TMOC20-3-1	28.5
		1.75	3E1.75ISOTM2...	3I1.75ISOTM2...	TMOC20-3-12	26.25
5/8"	27	2.0	3E2.0ISOTM2...	3I2.0ISOTM2...	TMOC20-3-10	28
		1.0	5E1.0ISOTM2...	5I1.0ISOTM2...	TMOC25-5-12	46
		1.0	5E1.0ISOTM2...	5I1.0ISOTM2...	TMOC25-5-16	47
		1.25	5E1.25ISOTM2...	5I1.25ISOTM2...	TMOC25-5-13	48.75
		1.5	5E1.5ISOTM2...	5I1.5ISOTM2...	TMOC25-5-14	48
		1.5	5E1.5ISOTM2...	5I1.5ISOTM2...	TMOC25-5-16	46.5
		1.75	5E1.75ISOTM2...	5I1.75ISOTM2...	TMOC25-5-15	47.25
		2.0	5E2.0ISOTM2...	5I2.0ISOTM2...	TMOC25-5-12	44
		2.5	5E2.5ISOTM2...	5I2.5ISOTM2...	TMOC25-5-12	45
		2.5	5E2.5ISOTM2...	5I2.5ISOTM2...	TMOC25-5-14	47.5
		3.0	5E3.0ISOTM2...	5I3.0ISOTM2...	TMOC25-5-16	45
		3.5	5E3.5ISOTM2...	5I3.5ISOTM2...	TMOC25-5-16	45.5
		4.0	5E4.0ISOTM2...	5I4.0ISOTM2...	TMOC25-5-12	44
4.5	5E4.5ISOTM2...	5I4.5ISOTM2...	TMOC25-5-14	45		
5.0		5I5.0ISOTM...028/075	TMOC25-5-12	40		

Bestellbeispiel: **2E0.75ISOTM2 VBX**

Für Le und Anzahl der Zähne der o. g. Platten
siehe Tabelle für Standardplatten auf Seite 209-210.

Informationen zu Trägerkörper auf Seite 239.

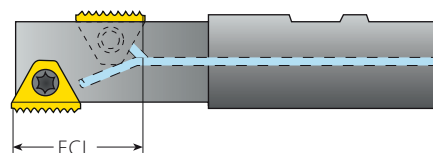

ECL – Die effektive Schneidlänge

ISO metrisch (Fortsetzung)

Außen / Innen

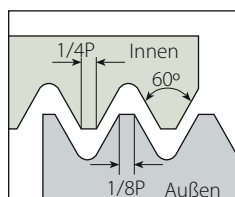

Norm: R262 (DIN 13)
 Toleranzklasse: 6g/6H

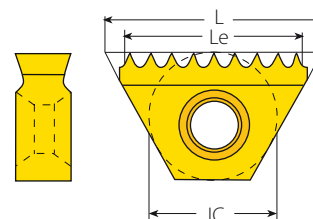

Feine Teilung TM

Feine Teilung TM

Plattengröße		Teilung		Bestellnummer		Le	Zähne	Trägerkörper
IC	L mm	mm	Außen	Innen	mm			
6.0mm	10.4	0.35	6.0E0.35ISOTMF...	6.0I0.35ISOTMF...	9.45	14	TMMC...-6.0	
		0.4	6.0E0.4ISOTMF...	6.0I0.4ISOTMF...	9.2	12		
		0.45	6.0E0.45ISOTMF...	6.0I0.45ISOTMF...	9.45	11		
		0.5	6.0E0.5ISOTMF...		9.5	10		
		0.6	6.0E0.6ISOTMF...		9.0	8		
		0.7	6.0E0.7ISOTMF...		9.1	7		
		0.75	6.0E0.75ISOTMF...		8.25	6		
		0.8	6.0E0.8ISOTMF...		8.8	6		
		0.9	6.0E0.9ISOTMF...		8.1	5		
1/4"	11	0.35	2E0.35ISOTM2F...	2I0.35ISOTM2F...	10.15	15	TMC...-2 TMSH...-2	
		0.4	2E0.4ISOTM2F...	2I0.4ISOTM2F...	10.0	13		
		0.45	2E0.45ISOTM2F...	2I0.45ISOTM2F...	9.45	11		
		0.5	2E0.5ISOTM2F...		9.5	10		
		0.6	2E0.6ISOTM2F...		10.2	9		
		0.7	2E0.7ISOTM2F...		9.1	7		
		0.8	2E0.8ISOTM2F...		8.8	6		
		0.9	2E0.9ISOTM2F...		9.9	6		
		3/8"	16	0.35	3E0.35ISOTM2F...	3I0.35ISOTM2F...		14.35
0.4	3E0.4ISOTM2F...			3I0.4ISOTM2F...	14.8	19		
0.45	3E0.45ISOTM2F...			3I0.45ISOTM2F...	14.85	17		
0.5	3E0.5ISOTM2F...				13.5	14		
0.6	3E0.6ISOTM2F...				13.8	12		
0.7	3E0.7ISOTM2F...				14.7	11		
0.8	3E0.8ISOTM2F...				13.6	9		
0.9	3E0.9ISOTM2F...				13.5	8		

HINWEIS: Zwei Umläufe sind zur Vollendung eines Gewindes erforderlich. TM- Platten für feine Teilungen erzeugen Teilprofilgewinde.

Bestellbeispiel: **6.0E0.35ISOTMF VBX**

Alle Platten besitzen zwei Schneidkanten, außer MiniTM (IC 6.0 mm) mit einer Schneidkante.

Informationen zu Fräseschäften auf Seite 234.

Gewinde Trägerkörpern Teilung

Gewinde mit feiner Teilung sind Gewinde mit kleinen Teilungen. Wegen des kleinen Radius zwischen den Zähnen ist es schwierig, Mehrzahnplatten für kleine Gewinde herzustellen. Vargus hat Platten entwickelt bei denen jeder zweite Zahn ausgelassen wurde, um den Radius zwischen den Zähnen zu vergrößern.

Wichtig!

- Alle Platten für feine Teilungen sind Teilprofilplatten (aufgrund des vergrößerten Radius).

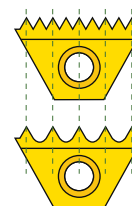

Amerikanisch UN

Außen / Innen

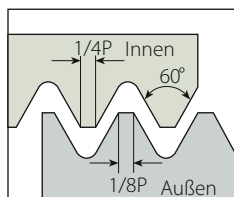

Norm: ANSI B1.10.74
 Toleranzklasse: Class 2A/2B

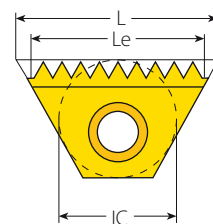

Standard TM

Standard TM

Plattengröße		Teilung	Bestellnummer		Le	Zähne	Trägerkörper
IC	L mm	G/Z	Außen	Innen	mm		
6.0mm	10.4	32		6.0I32UNTM...	9.53	12	TMMC...-6.0
		28		6.0I28UNTM...	9.07	10	
		24		6.0I24UNTM...	9.53	9	
		20		6.0I20UNTM...	8.89	7	
		18		6.0I18UNTM...	8.47	6	
		16		6.0I16UNTM...	7.94	5	
1/4"	11	48		2I48UNTM2...	10.05	19	TMC...-2 TMSH...-2
		40		2I40UNTM2...	10.16	16	
		32		2I32UNTM2...	10.32	13	
		28	2E28UNTM2...	2I28UNTM2...	9.98	11	
		27	2E27UNTM2...	2I27UNTM2...	10.35	11	
		24	2E24UNTM2...	2I24UNTM2...	9.53	9	
		20	2E20UNTM2...	2I20UNTM2...	10.16	8	
		18	2E18UNTM2...	2I18UNTM2...	9.88	7	
		16	2E16UNTM2...	2I16UNTM2...	9.53	6	
14	2E14UNTM2...	2I14UNTM2...	9.07	5			
3/8"	16	40		3I40UNTM2...	14.61	23	TMC...-3 TMSH...-3
		32		3I32UNTM2...	15.08	19	
		28	3E28UNTM2...	3I28UNTM2...	14.51	16	
		27	3E27UNTM2...	3I27UNTM2...	14.11	15	
		26	3E26UNTM2...	3I26UNTM2...	14.65	15	
		24	3E24UNTM2...	3I24UNTM2...	14.82	14	
		20	3E20UNTM2...	3I20UNTM2...	13.97	11	
		18	3E18UNTM2...	3I18UNTM2...	14.11	10	
		16	3E16UNTM2...	3I16UNTM2...	14.29	9	
		14	3E14UNTM2...	3I14UNTM2...	14.51	8	
		13	3E13UNTM2...	3I13UNTM2...	13.68	6	
		12	3E12UNTM2...	3I12UNTM2...	14.82	7	
3/8"B	22	24	3BE24UNTM2...	3BI24UNTM2...	21.16	20	BTMC...-3B TMSH...-3B
		20	3BE20UNTM2...	3BI20UNTM2...	21.59	17	
		18	3BE18UNTM2...	3BI18UNTM2...	21.17	15	
		16	3BE16UNTM2...	3BI16UNTM2...	20.64	13	
		14	3BE14UNTM2...	3BI14UNTM2...	21.77	12	
		13	3BE13UNTM2...	3BI13UNTM2...	21.49	11	
12	3BE12UNTM2...	3BI12UNTM2...	21.17	10			

Bestellbeispiel: 3E24UNTM2 VBX Alle Platten besitzen zwei Schneidkanten, außer MiniTM (IC 6.0 mm) mit einer Schneidkante. Informationen zu Trägerkörper auf Seite 234.

American UN (Fortsetzung)

Außen / Innen

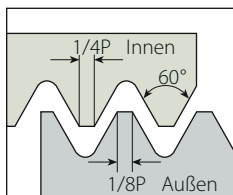

Norm: ANSI B1.10.74
 Toleranzklasse: Class 2A/2B

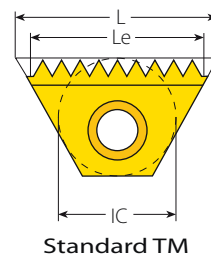

Standard TM

Plattengröße		Teilung	Bestellnummer		Le	Zähne	Trägerkörper
IC	L mm	G/Z	Außen	Innen	mm		
5/8"	27	24	5E24UNTM2...	5I24UNTM2...	25.40	24	TMC..-5 TMSH..-5
		20	5E20UNTM2...	5I20UNTM2...	25.40	20	
		18	5E18UNTM2...	5I18UNTM2...	25.40	18	
		16	5E16UNTM2...	5I16UNTM2...	25.40	16	
		14	5E14UNTM2...	5I14UNTM2...	25.40	14	
		13	5E13UNTM2...	5I13UNTM2...	25.40	13	
		12	5E12UNTM2...	5I12UNTM2...	25.40	12	
		11.5	5E11.5UNTM2...	5I11.5UNTM2...	24.30	11	
		11	5E11UNTM2...	5I11UNTM2...	25.40	11	
		10	5E10UNTM2...		22.86	9	
		10		5I10UNTM2...	25.40	10	
		9	5E9UNTM2...	5I9UNTM2...	22.58	8	
		8	5E8UNTM2...	5I8UNTM2...	22.23	7	
		7	5E7UNTM2...		21.77	6	
		7		5I7UNTM2...	25.40	7	
		6	5E6UNTM2...		21.17	5	
6		5I6UNTM2...	25.40	6			
3/4"B	38.5	6	6BE6UNTM2...	6BI6UNTM2...	38.87	8	TMC..-6B TMSH..-6B
		5	6BE5UNTM2...	6BI5UNTM2...	30.48	6	
		4.5	6BE4.5UNTM2...	6BI4.5UNTM2...	33.87	6	
		4	6BE4UNTM2...	6BI4UNTM2...	31.75	5	

Bestellbeispiel: **5E24UNTM2 VBX**

Alle Platten besitzen zwei Schneidkanten, außer MiniTM (IC 6.0 mm) mit einer Schneidkante.

Informationen zu Trägerkörper auf Seite 234.

American UN (Fortsetzung)

Innen

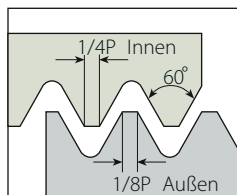

Norm: ANSI B1.10.74
 Toleranzklasse: Class 2A/2B

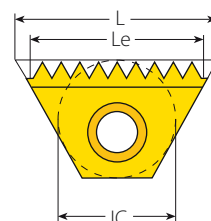

Regelgewinde TM

Regelgewinde TM

Gewinde	Plattengröße		Bestellnummer	Schneidkante	Le	Zähne	Trägerkörper	Bohrungsdurchmesserbereich
	IC	L mm						
7/16"-20UNF	6.0mm	10.4	6.0I20UNTM...028/012	1	8.89	7	TMMC12-6.0	9.7-11.4
7/16"-20UNF	6.0mm	10.4	6.0I20UNTM...028/012	1	8.89	7	TMMC20-6.0	9.7-11.4
7/16"-16UN	6.0mm	10.4	6.0I16UNTM...028/014	1	7.94	5	TMMC12-6.0	9.3-14.1
7/16"-16UN	6.0mm	10.4	6.0I16UNTM...028/014	1	7.94	5	TMMC20-6.0	9.3-14.1
7/16"-14UNC	6.0mm	10.4	6.0I14UNTM...028/013	1	9.07	5	TMMC20-6.0 124/003	9.1-9.9
1/2"-13UNC	1/4"	11	2I13UNTM...028/015	1	9.77	5	TMC20-2 124/005	10.5-19.5
1/2"-16UN	6.0mm	10.4	6.0I16UNTM...028/014	1	7.94	5	TMMC12-6.0	9.3-14.1
1/2"-16UN	6.0mm	10.4	6.0I16UNTM...028/014	1	7.94	5	TMMC20-6.0	9.3-14.1
9/16"-12UNC	1/4"	11	2I12UNTM...028/016	1	8.47	4	TMC20-2 124/005	11.9-15.6
9/16"-18UNF	1/4"	11	2I18UNTM...028/017	2	9.88	7	TMC12-2	12.7-14.5
9/16"-18UNF	1/4"	11	2I18UNTM...028/017	2	9.88	7	TMC20-2	12.7-14.5
9/16"-16UN	6.0mm	10.4	6.0I16UNTM...028/014	1	7.94	5	TMMC12-6.0	9.3-14.1
9/16"-16UN	6.0mm	10.4	6.0I16UNTM...028/014	1	7.94	5	TMMC20-6.0	9.3-14.1
5/8"-11UNC	1/4"	11	2I11UNTM...028/018	1	9.24	4	TMC20-2 124/006	13.3-18.5
5/8"-12UN	1/4"	11	2I12UNTM...028/016	1	8.47	4	TMC20-2 124/005	11.9-15.6
5/8"-16UN	6.0mm	10.4	6.0I16UNTM...028/014	1	7.94	5	TMMC12-6.0	9.3-14.1
5/8"-16UN	6.0mm	10.4	6.0I16UNTM...028/014	1	7.94	5	TMMC20-6.0	9.3-14.1
11/16"-12UN	1/4"	11	2I12UNTM...028/016	1	8.47	4	TMC20-2 124/005	11.9-15.6
3/4"-10UNC	3/8"	16	3I10UNTM...028/019	1	12.70	5	TMC16-3 124/001	16.3-31.6
3/4"-12UN	3/8"	16	3I12UNTM...028/020	2	14.82	7	TMNC16-3	16.7-18.3
13/16"-12UN	3/8"	16	3I12UNTM...028/020	2	14.82	7	TMC16-3	18.3-19.5
7/8"-9UNC	1/2"	22	4I9UNTM...028/021	1	16.93	6	TMC25-4 124/002	19.1-32.5

Weiter Nächste Seite ►

Beispiel Werkzeuganforderung für Gewinde 9/16"-12 UNC

Bestellnummern:

Platte: 2I12UNTMVBX 028/016

Fräaserschaft: TMC20-2 124/005

Informationen zu Trägerkörper auf Seite 234.

American UN (Fortsetzung)

Innen

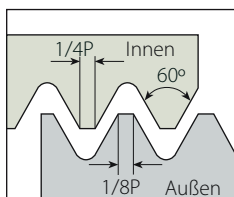

Norm: ANSI B1.10.74
 Toleranzklasse: Class 2A/2B

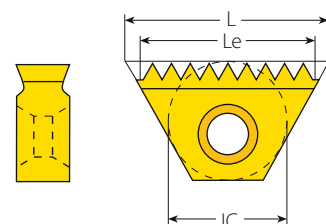

Regelgewinde TM

Regelgewinde TM(Fortsetzung)

Gewinde	Plattengröße		Bestellnummer	Schneidkante	Le	Zähne	Trägerkörper	Bohrungsdurchmesserbereich
	IC	L mm						
1"-8UNC	1/2"	22	418UNTM...028/022	1	19.05	6	TMC25-4 124/007	21.9-28.3
1 1/16"-8UN	1/2"	22	418UNTM...028/022	1	19.05	6	TMC25-4 124/007	21.9-28.3
1 1/8"-7UNC	1/2"	22	417UNTM...028/023	1	18.14	5	TMC25-4 124/002	24.6-35.9
1 1/8"-8UN	1/2"	22	418UNTM...028/022	1	19.05	6	TMC25-4 124/007	21.9-28.3
1 3/16"-8UN	1/2"	22	418UNTM...028/022	1	19.05	6	TMC25-4 124/007	21.9-28.3
1 1/4"-7UNC	1/2"	22	417UNTM...028/023	1	18.14	5	TMC25-4 124/002	24.6-35.9
1 1/4"-8UN	5/8"	27	518UNTM...028/024	2	22.23	7	TMC25-5 124/004	28.3-33.0
1 5/16"-8UN	5/8"	27	518UNTM...028/024	2	22.23	7	TMC25-5 124/004	28.3-33.0
1 3/8"-6UNC	5/8"	27	516UNTM...028/025	2	25.40	6	TMC25-5 124/004	30.3-36.7
1 3/8"-8UN	5/8"	27	518UNTM...028/024	2	22.23	7	TMC25-5 124/004	28.3-33.0
1 7/16"-6UN	5/8"	27	516UNTM...028/025	2	25.40	6	TMC25-5 124/004	30.3-36.7
1 7/16"-8UN	5/8"	27	518UNTM...028/024	2	22.23	7	TMC25-5	33.0-39.0
1 1/2"-6UNC	5/8"	27	516UNTM...028/025	2	25.40	6	TMC25-5 124/004	30.3-36.7
1 1/2"-8UN	5/8"	27	518UNTM...028/024	2	22.23	7	TMC25-5	33.0-39.0
1 9/16"-6UN	5/8"	27	516UNTM...028/025	2	25.40	6	TMC25-5 124/004	30.3-36.7
1 9/16"-8UN	5/8"	27	518UNTM...028/024	2	22.23	7	TMC25-5	33.0-39.0
1 5/8"-6UN	5/8"	27	516UNTM...028/025	2	25.40	6	TMC25-5	36.7-45.0
1 5/8"-8UN	5/8"	27	518UNTM...028/024	2	22.23	7	TMC25-5	33.0-39.0
1 11/16"-6UN	5/8"	27	516UNTM...028/025	2	25.40	6	TMC25-5	36.7-45.0
1 3/4"-5UNC	5/8"	27	515UNTM...028/077	2	20.32	4	TMC25-5	38.9-∞
1 3/4"-6UN	5/8"	27	516UNTM...028/025	2	25.40	6	TMC25-5	36.7-45.0
1 13/16"-6UN	5/8"	27	516UNTM...028/025	2	25.40	6	TMC25-5	36.7-45.0
1 7/8"-6UN	5/8"	27	516UNTM...028/025	2	25.40	6	TMC25-5	36.7-45.0
1 15/16"-6UN	5/8"	27	516UNTM...028/025	2	25.40	6	TMC25-5	36.7-45.0

Beispiel Werkzeuganforderung für Gewinde 1 9/16"-6 UN

Bestellnummern:

Platte: **516UNTM VBX 028/025**

Fräseschaft: **TMC 25-5 124/004**

Informationen zu Trägerkörper auf Seite 234.

American UN (Fortsetzung)

Außen / Innen

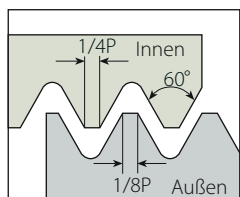

Norm: ANSI B1.10.74
Toleranzklasse: Class 2A/2B

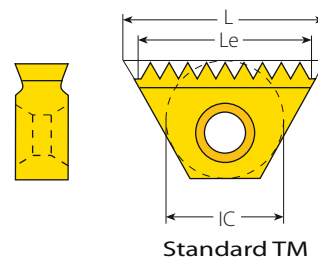

TM Doppelwendeplatten für TMO- Fräser

Plattengröße		Teilung	Bestellnummer		Trägerkörper	ECL
IC	L mm	G/Z	Außen	Innen	TMO	mm
1/4"	11	48		2I48UNTM2...	TMOC20-2-1	19.58
		48		2I48UNTM2...	TMOC20-2-2	18.52
		48		2I48UNTM2...	TMOC20-2-9	19.05
		32		2I32UNTM2...	TMOC20-2-1	19.85
		28	2E28UNTM2...	2I28UNTM2...	TMOC20-2-3	17.24
		24	2E24UNTM2...	2I24UNTM2...	TMOC20-2-2	17.99
		20	2E20UNTM2...	2I20UNTM2...	TMOC20-2-4	19.05
		18	2E18UNTM2...	2I18UNTM2...	TMOC20-2-2	18.34
		16	2E16UNTM2...	2I16UNTM2...	TMOC20-2-1	19.05
		14	2E14UNTM2...	2I14UNTM2...	TMOC20-2-3	16.33
3/8"	16	32		3I32UNTM2...	TMOC20-3-3	27.78
		32		3I32UNTM2...	TMOC20-3-11	28.58
		28	3E28UNTM2...	3I28UNTM2...	TMOC20-3-3	27.21
		27	3E27UNTM2...	3I27UNTM2...	TMOC20-3-4	27.28
		24	3E24UNTM2...	3I24UNTM2...	TMOC20-3-6	27.52
		20	3E20UNTM2...	3I20UNTM2...	TMOC20-3-6	26.67
		18	3E18UNTM2...	3I18UNTM2...	TMOC20-3-6	26.82
		16	3E16UNTM2...	3I16UNTM2...	TMOC20-3-6	26.99
		14	3E14UNTM2...	3I14UNTM2...	TMOC20-3-6	27.21
		13	3E13UNTM2...	3I13UNTM2...	TMOC20-3-2	25.4
		12	3E12UNTM2...	3I12UNTM2...	TMOC20-3-6	27.52
11.5	3E11.5UNTM2...	3I11.5UNTM2...	TMOC20-3-5	24.3		

Weiter Nächste Seite ►

Bestellbeispiel: **2E16UNTM2 VBX**

Für Le und Anzahl der Zähne der o. g. Platten
siehe Tabelle für Standardplatten auf Seite 214-215.
Informationen zu Trägerkörper auf Seite 239.

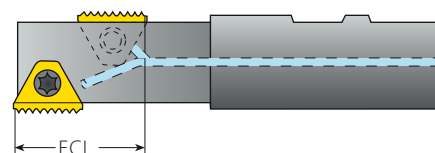

ECL – Die effektive Schneidenlänge

American UN (Fortsetzung)

Außen / Innen

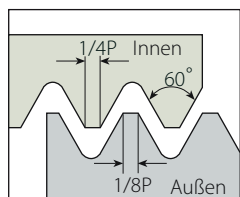

Norm: ANSI B1.10.74
 Toleranzklasse: Class 2A/2B

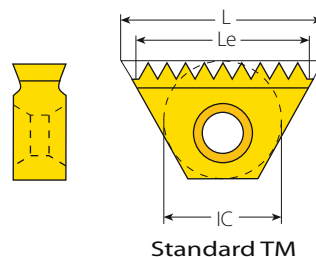

TM Wendepplatten für TMO- Fräser (Fortsetzung)

Plattengröße		Teilung	Bestellnummer		Trägerkörper	ECL
IC	L mm	G/Z	Außen	Innen	TMO	mm
5/8"	27	24	5E24UNTM2..	5I24UNTM2..	TMOC25-5-1	50.80
		24	5E24UNTM2...	5I24UNTM2...	TMOC25-5-2	46.57
		20	5E20UNTM2...	5I20UNTM2...	TMOC25-5-1	50.80
		18	5E18UNTM2...	5I18UNTM2...	TMOC25-5-1	50.80
		18	5E18UNTM2...	5I18UNTM2...	TMOC25-5-2	46.57
		16	5E16UNTM2...	5I16UNTM2...	TMOC25-5-3	47.63
		14	5E14UNTM2...	5I14UNTM2...	TMOC25-5-1	50.80
		14	5E14UNTM2...	5I14UNTM2...	TMOC25-5-4	47.17
		13	5E13UNTM2...	5I13UNTM2...	TMOC25-5-1	50.80
		12	5E12UNTM2...	5I12UNTM2...	TMOC25-5-2	46.57
		12	5E12UNTM2...	5I12UNTM2...	TMOC25-5-1	50.80
		11.5	5E11.5UNTM2...	5I11.5UNTM2...	TMOC25-5-5	46.38
		11	5E11UNTM2...	5I11UNTM2...	TMOC25-5-6	48.49
		11		5I11UNTM2...	TMOC25-5-1	46.18
		10	5E10UNTM2...		TMOC25-5-7	43.18
		10		5I10UNTM2...	TMOC25-5-7	45.72
		9	5E9UNTM2...	5I9UNTM2...	TMOC25-5-8	45.16
		8	5E8UNTM2...	5I8UNTM2...	TMOC25-5-9	44.45
		7	5E7UNTM2...		TMOC25-5-10	43.54
		7		5I7UNTM2...	TMOC25-5-10	47.17
6	5E6UNTM2...		TMOC25-5-2	42.33		
6		5I6UNTM2...	TMOC25-5-2	46.57		
5		5I5UNTM...028/077	TMOC25-5-7	40.64		

Bestellbeispiel: **5E16UNTM2 VBX**

Für Le und Anzahl der Zähne der o. g. Platten
 siehe Tabelle für Standardplatten auf Seite 214-215.
 Informationen zu Trägerkörper auf Seite 239.

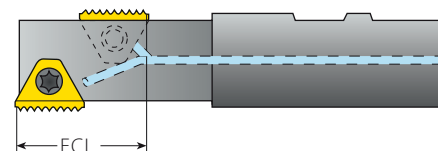

ECL – Die effektive Schneidenlänge

American UN (Fortsetzung)

Außen / Innen

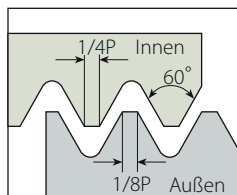

Norm: ANSI B1.10.74
Toleranzklasse: Class 2A/2B

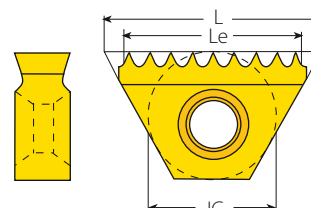

Feine Teilung TM

Feine Teilung TM

Plattengröße		Teilung		Bestellnummer		Le	Zähne	Trägerkörper
IC	L mm	G/Z	Außen	Innen	mm			
6.0mm	10.4	80	6.0E80UNTMF...	6.0I80UNTMF...	9.84	16	TMMC...-6.0	
		72	6.0E72UNTMF...	6.0I72UNTMF...	9.53	14		
		64	6.0E64UNTMF...	6.0I64UNTMF...	9.13	12		
		56	6.0E56UNTMF...	6.0I56UNTMF...	9.53	11		
		48	6.0E48UNTMF...	6.0I48UNTMF...	9.00	9		
		44	6.0E44UNTMF...		8.66	8		
		40	6.0E40UNTMF...		8.26	7		
		36	6.0E36UNTMF...		9.17	7		
1/4"	11	80	2E80UNTM2F...	2I80UNTM2F...	9.84	16	TMC...-2 TMSH...-2	
		72	2E72UNTM2F...	2I72UNTM2F...	10.23	15		
		64	2E64UNTM2F...	2I64UNTM2F...	9.92	13		
		56	2E56UNTM2F...	2I56UNTM2F...	9.53	11		
		48	2E48UNTM2F...		10.05	10		
		44	2E44UNTM2F...		9.81	9		
		40	2E40UNTM2F...		9.53	8		
		36	2E36UNTM2F...		9.17	7		
3/8"	16	80	3E80UNTM2F...	3I80UNTM2F...	14.29	23	TMC...-3 TMSH...-3	
		72	3E72UNTM2F...	3I72UNTM2F...	14.46	21		
		64	3E64UNTM2F...	3I64UNTM2F...	14.68	19		
		56	3E56UNTM2F...	3I56UNTM2F...	14.06	16		
		48	3E48UNTM2F...		14.29	14		
		44	3E44UNTM2F...		14.43	13		
		40	3E40UNTM2F...		14.61	12		
		36	3E36UNTM2F...		14.82	11		
		32	3E32UNTM2F...		13.49	9		

HINWEIS: Zwei Umläufe sind zur Vollendung eines Gewindes erforderlich. TM- Platten für feine Teilungen erzeugen Teilprofilgewinde.

Bestellbeispiel: **6.0E80UNTMF VBX**

Alle Platten besitzen zwei Schneidkanten, außer MiniTM (IC 6.0 mm) mit einer Schneidkante.

Informationen zu Trägerkörpern auf Seite 234.

Gewinde mit feiner Teilung

Gewinde mit feiner Teilung sind Gewinde mit kleinen Teilungen. Wegen des kleinen Radius zwischen den Zähnen ist es schwierig, Mehrzahnplatten für kleine Gewinde herzustellen. Vargus hat Platten entwickelt bei denen jeder zweite Zahn ausgelassen wurde, um den Radius zwischen den Zähnen zu vergrößern.

Wichtig!

- Alle Platten für feine Teilungen sind Teilprofilplatten (aufgrund des vergrößerten Radius).

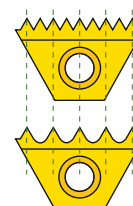

UNJ

Außen / Innen

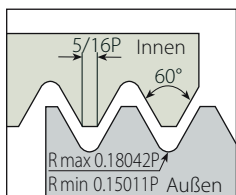

Norm: MIL-S-8879C
 Toleranzklasse: 3A/3B

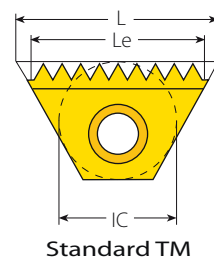

Standard TM

Standard TM

Plattengröße		Teilung	Bestellnummer		Le	Zähne	Trägerkörper
IC	L mm		External	Internal			
6.0mm	10.4	24		6.0I24UNJTM...	9.53	9	TMMC...-6.0
		20		6.0I20UNJTM...	8.89	7	
		18		6.0I18UNJTM...	8.47	6	
		16		6.0I16UNJTM...	9.53	6	
1/4"	11	24	2E24UNJTM2...	2I24UNJTM2...	9.53	9	TMC...-2 TMSH...-2
		20	2E20UNJTM2...	2I20UNJTM2...	10.16	8	
		18		2I18UNJTM2...	9.88	7	
		16	2E16UNJTM2...	2I16UNJTM2...	9.53	6	
		14	2E14UNJTM2...	2I14UNJTM2...	9.07	5	
3/8"	16	24	3E24UNJTM2...	3I24UNJTM2...	14.82	14	TMC...-3 TMSH...-3
		20	3E20UNJTM2...	3I20UNJTM2...	13.97	11	
		18	3E18UNJTM2...	3I18UNJTM2...	14.11	10	
		16	3E16UNJTM2...	3I16UNJTM2...	14.29	9	
		14	3E14UNJTM2...	3I14UNJTM2...	14.51	8	
		12	3E12UNJTM2...	3I12UNJTM2...	14.82	7	
5/8"	27	16	5E16UNJTM2...	5I16UNJTM2...	25.40	16	TMC...-5 TMSH...-5
		12	5E12UNJTM2...	5I12UNJTM2...	25.40	12	
		11	5E11UNJTM2...	5I11UNJTM2...	25.40	11	

Bestellnummer für Platte: **3E16UNJTM2 VBX**

Alle Platten besitzen zwei Schneidkanten, außer MiniTM (IC 6.0 mm) mit einer Schneidkante.

Informationen zu Trägerkörpern auf Seite 234.

W für BSW, BSP

Außen / Innen

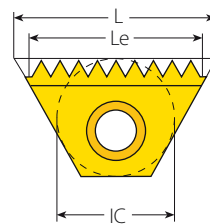
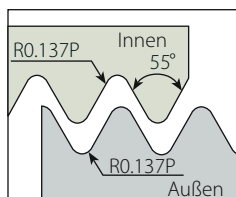

Standard TM

BSW Norm: B.S.84:1956, DIN 259, ISO228/1:1982

BSP Norm: B.S.2779:1956

Toleranzklasse: BSW-Medium class A, BSP-Medium class

Standard TM

Plattengröße		Teilung	Bestellnummer	Le	Zähne	Trägerkörper
IC	L mm	G/Z	Außen + Innen	mm		
6.0mm	10.4	28	6.0EI28WTM...	9.07	10	TMMC...-6.0
		26	6.0EI26WTM...	8.79	9	
		24	6.0EI24WTM...	9.53	9	
		20	6.0EI20WTM...	8.89	7	
		19	6.0EI19WTM...	9.36	7	
1/4"	11	28	2EI28WTM2...	9.98	11	TMC...-2 TMSH...-2
		26	2EI26WTM2...	9.77	10	
		24	2EI24WTM2...	9.53	9	
		20	2EI20WTM2...	10.16	8	
		19	2EI19WTM2...	9.36	7	
3/8"	16	26	3EI26WTM2...	14.65	15	TMC...-3 TMSH...-3
		24	3EI24WTM2...	14.82	14	
		20	3EI20WTM2...	13.97	11	
		19	3EI19WTM2...	14.71	11	
		18	3EI18WTM2...	14.11	10	
		16	3EI16WTM2...	14.29	9	
		14	3EI14WTM2...	14.51	8	
3/8"B	22	12	3EI12WTM2...	14.82	7	TMC...-3B TMSH...-3B
		11	3EI11WTM2...	13.85	6	
		24	3BEI24WTM2...	21.17	20	
		20	3BEI20WTM2...	21.59	17	
		19	3BEI19WTM2...	21.39	16	
		18	3BEI18WTM2...	21.17	15	
		16	3BEI16WTM2...	20.64	13	
5/8"	27	14	3BEI14WTM2...	21.77	12	TMC...-5 TMSH...-5
		12	3BEI12WTM2...	21.17	10	
		11	3BEI11WTM2...	20.78	9	
		16	5EI16WTM2...	25.40	16	
		14	5EI14WTM2...	25.40	14	
		12	5EI12WTM2...	23.28	11	
		11	5EI11WTM2...	23.09	10	
		10	5EI10WTM2...	25.40	10	
3/4"B	38.5	9	5EI9WTM2...	22.58	8	TMC...-6B TMSH...-6B
		8	5EI8WTM2...	22.23	7	
		7	5EI7WTM2...	21.77	6	
		6	5EI6WTM2...	21.17	5	
		11	6BEI11WTM2...	34.64	15	
		6	6BEI6WTM2...	33.87	8	
		5	6BEI5WTM2...	30.48	6	
		4.5	6BEI4.5WTM2...	33.87	6	

W nur für BSW (Fortsetzung)

Außen / Innen

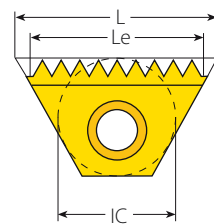
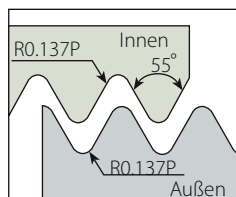

Regelgewinde TM

Norm: B.S.84:1956, DIN259, ISO228/1:1982
 Toleranzklasse: Medium class A

Regelgewinde TM

Gewinde	Plattengröße		Bestellnummer	Schneidkante	Le	Zähne	Trägerkörper	Bohrungsdurchmesserbereich
Zoll	IC	L mm	Innen		mm			mm
7/16"-18	6.0mm	10.4	6.0I18WTM...028/035	1	8.47	6	TMMC12-6.0	9.3-14.2
7/16"-18	6.0mm	10.4	6.0I18WTM...028/035	1	8.47	6	TMMC20-6.0	9.3-14.2
7/16"-26	6.0mm	10.4	6.0I26WTM... 028/036	1	8.79	9	TMMC12-6.0	9.8-10.5
7/16"-26	6.0mm	10.4	6.0I26WTM... 028/036	1	8.79	9	TMMC20-6.0	9.8-10.5
1/2"-16	1/4"	11	2I16WTM... 028/051	1	9.53	6	TMC20-2 124/005	10.6-12.2
1/2"-20	6.0mm	10.4	6.0I20WTM...028/037	1	8.89	7	TMMC12-6.0	11.0-11.4
1/2"-20	6.0mm	10.4	6.0I20WTM...028/037	1	8.89	7	TMMC20-6.0	11.0-11.4
9/16"-16	1/4"	11	2I16WTM...028/038	2	9.53	6	TMC12-2	12.2-18.5
9/16"-16	1/4"	11	2I16WTM...028/038	2	9.53	6	TMC20-2	12.2-18.5
5/8"-14	1/4"	11	2I14WTM...028/039	1	9.07	5	TMC20-2 124/006	13.5-19.0
11/16"-14	1/4"	11	2I14WTM...028/039	1	9.07	5	TMC20-2 124/006	13.5-19.0
11/16"-16	1/4"	11	2I16WTM...028/038	2	9.53	6	TMC12-2	12.2-18.5
11/16"-16	1/4"	11	2I16WTM...028/038	2	9.53	6	TMC20-2	12.2-18.5
3/4"-12	3/8"	16	3I12WTM...028/040	1	14.82	7	TMC16-3 124/001	16.3-17.9
3/4"-16	1/4"	11	2I16WTM...028/038	2	9.53	6	TMC12-2	12.2-18.5
3/4"-16	1/4"	11	2I16WTM...028/038	2	9.53	6	TMC20-2	12.2-18.5
13/16"-12	3/8"	16	3I12WTM...028/041	2	14.82	7	TMC16-3	17.9-21.0
7/8"-9	1/2"	22	4I9WTM...028/042	1	16.93	6	TMC25-4 124/002	18.6-32.5
7/8"-11	1/2"	22	4I11WTM...028/043	1	18.47	8	TMC25-4 124/002	19.2-22.0
15/16"-12	3/8"	16	3I12WTM...028/041	2	14.82	7	TMC20-3	21.0-30.6
1"-8	1/2"	22	4I8WTM...028/044	1	15.88	5	TMC25-4 124/002	21.3-26.0
1"-10	1/2"	22	4I10WTM...028/045	1	17.78	7	TMC25-4 124/002	22.1-31.6
1"-12	3/8"	16	3I12WTM...028/041	2	14.82	7	TMC20-3	21.0-30.6
1 1/16"-12	3/8"	16	3I12WTM...028/041	2	14.82	7	TMC20-3	21.0-30.6
1 1/8"-7	5/8"	27	5I7WTM...028/046	1	21.77	6	TMC25-5 124/008	23.9-27.1
1 1/8"-9	1/2"	22	4I9WTM...028/042	1	16.93	6	TMC25-4 124/002	18.6-32.5
1 1/8"-12	3/8"	16	3I12WTM...028/041	2	14.82	7	TMC20-3	21.0-30.6
1 3/16"-8	5/8"	27	5I8WTM...028/047	2	22.23	7	TMC25-5 124/004	26.0-32.4
1 3/16"-12	3/8"	16	3I12WTM...028/041	2	14.82	7	TMC20-3	21.0-30.6
1 1/4"-7	5/8"	27	5I7WTM...028/048	2	21.77	6	TMC25-5 124/004	21.7-35.9
1 1/4"-9	1/2"	22	4I9WTM...028/042	1	16.93	6	TMC25-4 124/002	18.6-32.5
1 1/4"-12	3/8"	16	3I12WTM...028/041	2	14.82	7	TMC20-3	21.0-30.6
1 5/16"-6	5/8"	27	5I6WTM...028/049	2	21.17	5	TMC25-5 124/004	27.9-32.6
1 5/16"-8	5/8"	27	5I8WTM...028/047	2	22.23	7	TMC25-5 124/004	26.0-32.4

Weiter Nächste Seite ►

Beispiel Werkzeuganforderung für Gewinde 7/16"-18 BSW

Bestellnummern: Platte: **6.0I18WTM VBX 028/035** Trägerkörper: **TMMC 20-6.0**

Informationen zu Trägerkörpern auf Seite 234.

W nur für BSW (Fortsetzung)

Innen

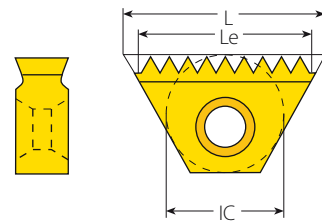
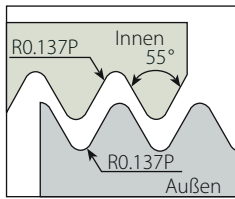

Norm: B.S.84:1956, DIN259, ISO228/1:1982
Toleranzklasse: Medium class A

Regelgewinde TM Inserts

Regelgewinde TM

Gewinde	Plattengröße		Bestellnummer	Schneidkante	Le	Zähne	Trägerkörper	Bohrungsdurchmesserbereich
	IC	L mm						
1 5/16"-12	3/8"	16	3112WTM...028/041	2	14.82	7	TMC20-3	21.0-30.6
1 3/8"-8	5/8"	27	518WTM...028/047	2	22.23	7	TMC25-5 124/004	26.0-32.4
1 3/8"-6	5/8"	27	516WTM...028/049	2	21.17	5	TMC25-5 124/004	27.9-32.6
1 3/8"-12	5/8"	27	5112WTM...028/050	2	23.28	11	TMC25-5	32.2-34.6
1.4-6	5/8"	27	516WTM...028/049	2	21.17	5	TMC25-5 124/004	27.9-32.6
1.4-8	5/8"	27	518WTM...028/047	2	22.23	7	TMC25-5124/004	26.0-32.4
1.4-12	5/8"	27	5112WTM...028/050	2	23.28	11	TMC25-5	32.2-34.6
1 7/16"-6	5/8"	27	516WTM...028/049	2	21.17	5	TMC25-5 124/004	27.9-32.6
1 7/16"-8	5/8"	27	518WTM...028/047	2	22.23	7	TMC25-5	32.4-39.0
1 7/16"-12	5/8"	27	5112WTM...028/050	2	23.28	11	TMC25-5	32.2-34.6
1 1/2"-6	5/8"	27	516WTM...028/049	2	21.17	5	TMC25-5 124/004	27.9-32.7
1 1/2"-8	5/8"	27	518WTM...028/047	2	22.23	7	TMC25-5	32.4-39.0
1.6-6	5/8"	27	516WTM...028/049	2	21.17	5	TMC25-5	32.6-38.5
1.6-8	5/8"	27	518WTM...028/047	2	22.23	7	TMC25-5	32.4-39.0
1 5/8"-8	5/8"	27	518WTM...028/047	2	22.23	7	TMC25-5	32.4-39.0
1 5/8"-6	5/8"	27	516WTM...028/049	2	21.17	5	TMC25-5	32.6-38.5
1 3/4"-7	5/8"	27	517WTM...028/048	2	21.77	6	TMC25-5	39.8-42.0
1 7/8"-6	5/8"	27	516 WTM...028/049	2	21.17	5	TMC32-5	42.2-45.0
1.9-6	5/8"	27	516 WTM...028/049	2	21.17	5	TMC32-5	42.2-45.0

Beispiel Werkzeuganforderung für Gewinde 1 5/16"-12 BSW

Bestellnummern: Platte: **3112WTM VBX 028/041**

Trägerkörper: **TMC 20-3**

Informationen zu Trägerkörpern auf Seite 234.

W nur für BSW (Fortsetzung)

Außen / Innen

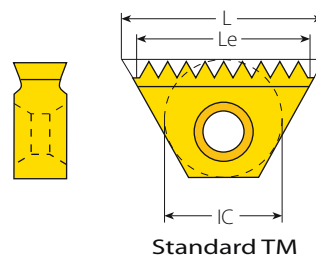
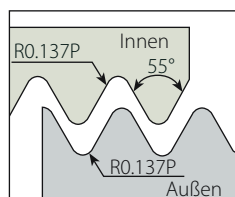

BSW Norm: B.S.84:1956, DIN 259, ISO228/1:1982

BSP Norm: B.S.2779:1956

Toleranzklasse: BSW-Medium class A, BSP-Medium class

TM Doppelwendeplatten für TMO- Fräser

Plattengröße		Teilung	Bestellnummer	ECL	
IC	L mm	G/Z	Außen + Innen	TMO	
1/4"	11	28	2EI28WTM2...	TMOC20-2-3	17.24
		26	2EI26WTM2...	TMOC20-2-5	18.56
		24	2EI24WTM2...	TMOC20-2-2	17.99
		20	2EI20WTM2...	TMOC20-2-6	19.05
		19	2EI19WTM2...	TMOC20-2-7	17.38
		14	2EI14WTM2...	TMOC20-2-3	16.33
3/8"	16	26	3EI26WTM2...	TMOC20-3-2	27.35
		26	3EI26WTM2...	TMOC20-3-6	26.38
		24	3EI24WTM2...	TMOC20-3-7	28.57
		20	3EI20WTM2...	TMOC20-3-6	26.67
		19	3EI19WTM2...	TMOC20-3-8	28.07
		18	3EI18WTM2...	TMOC20-3-6	26.81
		16	3EI16WTM2...	TMOC20-3-6	26.99
		14	3EI14WTM2...	TMOC20-3-6	27.21
5/8"	27	16	5EI16WTM2...	TMOC25-5-3	47.63
		14	5EI14WTM2...	TMOC25-5-1	50.80
		14	5EI14WTM2...	TMOC25-5-4	47.17
		12	5EI12WTM2...	TMOC25-5-2	44.45
		11	5EI11WTM2...	TMOC25-5-6	46.18
		10	5EI10WTM2...	TMOC25-5-7	45.72
		9	5EI9WTM2...	TMOC25-5-8	45.16
		8	5EI8WTM2...	TMOC25-5-9	44.45
		7	5EI7WTM2...	TMOC25-5-4	43.54
		6	5EI6WTM2...	TMOC25-5-11	42.33

Bestellbeispiel: 3EI19WTM2 VBX

Für Le und Anzahl der Zähne der o. g. Platten
 siehe Tabelle für Standardplatten auf Seite 222.

Informationen zu Trägerkörpern auf Seite 239.

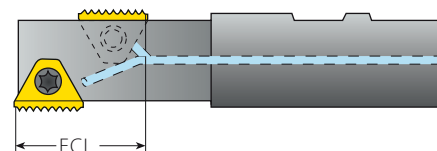

ECL – Die effektive Schneidenlänge

NPT

Außen / Innen

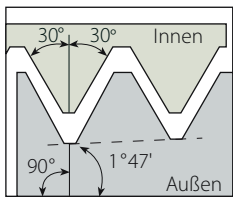

Norm: USAS B2.1:1968
Toleranzklasse: Standard NPT

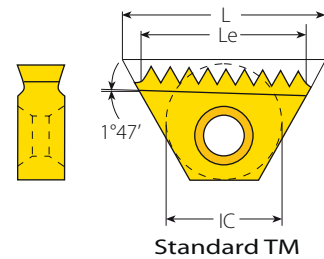

Standard TM

Standard TM

Plattengröße		Teilung		Bestellnummer	Le	Zähne	Trägerkörper	
IC	L mm	G/Z	Außen + Innen		mm		RH	LH
3/8"	16	18	3E18NPTTM2... **		14.11	10		
		14	3E14NPTTM2...		14.51	8	TMNC...-3	TMNC...-3LH
		11.5	3E11.5NPTTM2...		13.25	6		
3/8"B	22	14	3BE14NPTTM2...		21.77	12	BTMNC...-3B	BTMNC...-3BLH
		11.5	3BE11.5NPTTM2... *		19.88	9		
5/8"	27	11.5	5E11.5NPTTM2...		24.30	11	TM.C...-5	TM.C...-5LH
		8	5E18NPTTM2...		22.23	7		
3/4"B	38.5	11.5	6BE11.5NPTTM2...		35.34	16	TMC...-6B	TMC...-6BLH
		8	6BE18NPTTM2...		31.75	10		

* Platte einseitig – nur RH

** Nur für Aussengewinde

Bestellbeispiel: **3E14NPTTM VBX**

HINWEIS: Mit "L" markierte Schneidkanten erfordern einen LH- Trägerkörper.

Informationen zu Trägerkörpern auf Seite 234.

NPT

Innen

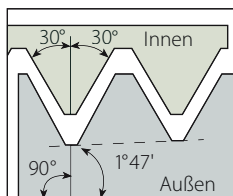

Norm: USAS B2.1:1968
Toleranzklasse: Standard NPT

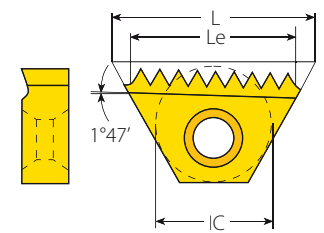

Regelgewinde TM

Regelgewinde TM

Gewinde	Plattengröße		Bestellnummer	Schneidkante	Le	Zähne	Trägerkörper
Zoll	IC	L mm	Innen		mm		
1/4"-18	1/4"	11	2118NPTTM...028/074	1	9.88	7	TMC 20-2 124/009
3/8"-18	1/4"	11	2118NPTTM...028/074	1	9.88	7	TMC 20-2 124/009

Bestellbeispiel: **2118NPTTM VBX 028/074**

HINWEIS: Mit "L" markierte Schneidkanten erfordern einen LH- Trägerkörper.

Informationen zu Trägerkörpern auf Seite 234.

NPTF (Dry Seal)

Außen / Innen

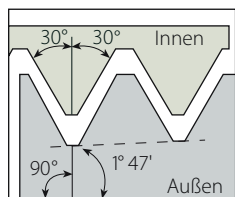

Norm: ANSI 1.20.3-1976
 Toleranzklasse: Standard NPTF

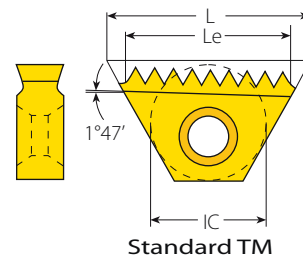

Standard TM

Plattengröße		Teilung		Bestellnummer	Le	Zähne	Trägerkörper	
IC	L mm	G/Z	Außen + Innen		mm		RH	LH
3/8"	16	14	3EI14NPTFTM2...	14.51	8	TMNC..-3		TMNC..-3LH
		11.5	3EI11.5NPTFTM2...	13.25	6			
3/8"B	22	14	3BEI14NPTFTM2...	21.77	12	BTMNC..-3B		BTMNC..-3BLH
		11.5	3BEI11.5NPTFTM2...	19.88	9			
5/8"	27	11.5	5EI11.5NPTFTM2...	24.30	11	TM.C..-5		TM.C..-5LH
		8	5EI8NPTFTM2...	22.23	7			
3/4"B	38.5	11.5	6BEI11.5NPTFTM2...	35.34	16	TMC..-6B		TMC..-6BLH
		8	6BEI8NPTFTM2...	31.75	10			

Bestellbeispiel: 3EI14NPTFTM VBX

HINWEIS: Mit "L" markierte Schneidkanten erfordern einen LH- Trägerkörper.

Informationen zu Trägerkörpern auf Seite 234.

NPTF (Dry Seal)

Innen

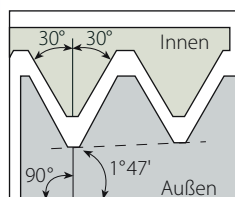

Norm: ANSI 1.20.3-1976
 Toleranzklasse: Standard NPTF

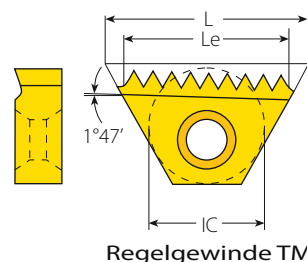

Regelgewinde TM

Gewinde	Plattengröße		Bestellnummer	Schneidkante	Le	Zähne	Trägerkörper
Zoll	IC	L mm	Innen		mm		
1/4"-18	1/4"	11	2I18NPTFTM...028/078	1	9.88	7	TMC20-2 124/009
3/8"-18	1/4"	11	2I18NPTFTM...028/078	1	9.88	7	TMC20-2 124/009

Beispiel Werkzeuganforderung für Gewinde 1/4" - 18 NPTF

Bestellnummer Platte: 2I18NPTFTM VBX 028/078

Trägerkörper: TMC20-2 124/009

NPS

Außen / Innen

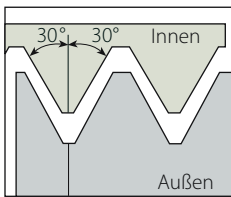

Norm: USA NBS H28 (1957)
 Toleranzklasse: Standard NPS

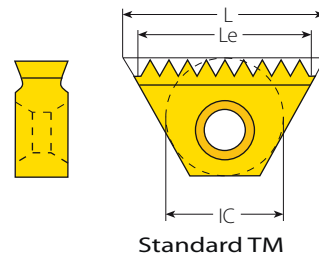

Standard TM

Plattengröße		Teilung		Bestellnummer	Le	Zähne	Nenn-Mass	Trägerkörper
IC	L mm	G/Z	Außen + Innen		mm			
3/8"	16	14	3EI14NPSTM2...		14.51	8	1/2"	TMNC16-3
		14	3EI14NPSTM2...		14.51	8	3/4"	TMNC20-3
		11.5	3EI11.5NPSTM2...		13.25	6	1", 1 1/4"	TMNC20-3
3/8"B	22	11.5	3BEI11.5NPSTM2...*		19.88	9	1", 1 1/4"	BTMNC20-3B
5/8"	27	11.5	5EI11.5NPSTM2...		24.30	11	1 1/2", 2"	TMC25-5
		8	5EI8NPSTM2...		22.23	7	2 1/2" & larger	TMC32-5

Bestellbeispiel: 5EI11.5NPSTM2VBX

Alle Platten besitzen zwei Schneidkanten.

Informationen zu Trägerkörpern auf Seite 234.

* Eine Schneidkante.

BSPT

Außen / Innen

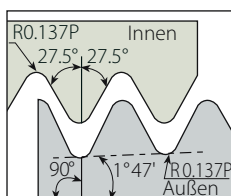

Norm: B.S. 21:1985
 Toleranzklasse: DIN EN 10226-1

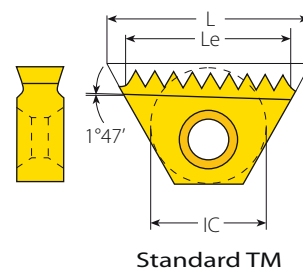

Standard TM

Plattengröße		Teilung		Bestellnummer	Le	Zähne	Trägerkörper	
IC	L mm	G/Z	Außen + Innen		mm		RH	LH
1/4"	11	19	2EI19BSPTTM2...		9.36	7	TMNC..-2	TMC..-2LH
3/8"	16	14	3EI14BSPTTM2...		14.51	8	TMNC..-3	TMNC..-3LH
		11	3EI11BSPTTM2...		13.85	6		
5/8"	27	11	5EI11BSPTTM2...		23.09	10	TMC..-5	TMC..-5LH

Bestellbeispiel: 5EI11BSPTTM VBX

HINWEIS: Mit "L" markierte Schneidkanten erfordern einen LH- Trägerkörper.

Informationen zu Trägerkörpern auf Seite 234.

Pg

Außen / Innen

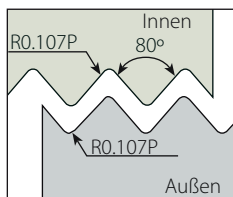

Norm: DIN 40430
 Toleranzklasse: Standard

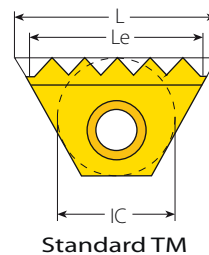

Standard TM

Plattengröße		Teilung		Bestellnummer	Le	Zähne	Nenn-Mass	Trägerkörper
IC	L mm	G/Z	Außen + Innen		mm			
6.0mm	10.4	20	6.0EI20PGTM...		8.99	7	Pg7	TMMC...-6.0
1/4"	11	20	2EI20PGTM2...		10.16	8	Pg7	TMC...-2
		18	2EI18PGTM2...		9.88	7	Pg9, Pg11, Pg13.5, Pg16	TMSH...-2
		16	2EI16PGTM2...		9.53	6	Pg21, Pg29, Pg36, Pg42, Pg48	
3/8"	16	20	3EI20PGTM2...		13.97	11	Pg7	TMC...-3
		18	3EI18PGTM2...		14.11	10	Pg9, Pg11, Pg13.5, Pg16	TMSH...-3
		16	3EI16PGTM2...		14.29	9	Pg21, Pg29, Pg36, Pg42, Pg48	
5/8"	27	16	5EI16PGTM2...		25.40	16	Pg21, Pg29, Pg36, Pg42, Pg48	TMC...-5, TMSH...-5

Bestellnummer für Platte: **5EI16PGTM2VBX**

Alle Platten besitzen zwei Schneidkanten, außer MiniTM (IC 6.0 mm) mit einer Schneidkante.

Informationen zu Trägerkörpern auf Seite 234.

ACME

Innen

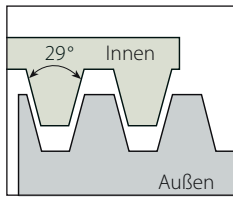

Norm: ANSI B1/5:1988
 Toleranzklasse: 3G

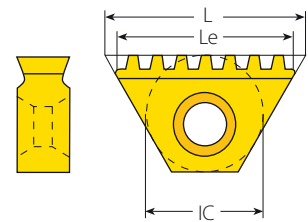

Regelgewinde TM

Regelgewinde TM

Gewinde	Plattengröße		Bestellnummer	Schneidkante	Le	Zähne	Trägerkörper	Bohrungsdurchmesserbereich
Zoll	IC	L mm	Innen		mm			mm
1/2"-16	6.0mm	10.4	6.0I16ACMETM...028/052	1	7.94	5	TMMC12-6.0	11.1
1/2"-16	6.0mm	10.4	6.0I16ACMETM...028/052	1	7.94	5	TMMC20-6.0	11.1
5/8"-16	1/4"	11	2I16ACMETM...028/053	2	9.53	6	TMC12-2	14.2
5/8"-16	1/4"	11	2I16ACMETM...028/053	2	9.53	6	TMC20-2	14.2
5/8"-14	1/4"	11	2I14ACMETM...028/054	1	9.07	5	TMC20-2 124/005	14.0
3/4"-16	1/4"	11	2I16ACMETM...028/055	2	9.53	6	TMC12-2	17.4
3/4"-16	1/4"	11	2I16ACMETM...028/055	2	9.53	6	TMC20-2	17.4
3/4"-14	1/4"	11	2I14ACMETM...028/083	1	9.07	5	TMC20-2 124/006	17.2
3/4"-12	1/4"	11	2I12ACMETM...028/056	1	8.47	4	TMC20-2 124/006	16.9
7/8"-14	3/8"	16	3I14ACMETM...028/057	2	14.51	8	TMNC16-3	20.4
7/8"-12	1/4"	11	2I12ACMETM...028/058	1	8.47	4	TMC20-2 124/006	20.1
1"-14	3/8"	16	3I14ACMETM...028/059	2	14.51	8	TMC16-3	23.5
1"-12	3/8"	16	3I12ACMETM...028/060	2	14.82	7	TMNC16-3	23.2
1"-10	1/2"	22	4I10ACMETM...028/061	1	17.78	7	TMC25-4 124/002	22.8
1"-8	1/2"	22	4I8ACMETM...028/062	1	19.05	6	TMC25-4 124/002	22.2
1 1/8"-12	3/8"	16	3I12ACMETM...028/060	2	14.82	7	TMC16-3	26.4
1 1/8"-10	1/2"	22	4I10ACMETM...028/084	1	17.78	7	TMC25-4 124/007	26.0
1 1/8"-8	1/2"	22	4I8ACMETM...028/063	1	19.05	6	TMC25-4 124/002	25.4-28.5
1 1/4"-12	3/8"	16	3I12ACMETM...028/060	2	14.82	7	TMC20-3	29.6
1 1/4"-10	5/8"	27	5I10ACMETM...028/064	2	22.86	9	TMC25-5 124/004	29.2
1 1/4"-8	1/2"	22	4I8ACMETM...028/063	1	19.05	6	TMC25-4 124/002	25.4-28.5
1 3/8"-10	5/8"	27	5I10ACMETM...028/065	2	22.86	9	TMC25-5 124/004	32.3
1 3/8"-8	5/8"	27	5I8ACMETM...028/066	2	22.23	7	TMC25-5 124/004	31.7
1 3/8"-6	5/8"	27	5I6ACMETM...028/067	1	21.17	5	TMC25-5 124/008	30.6
1 1/2"-10	5/8"	27	5I10ACMETM...028/068	2	22.86	9	TMC25-5	35.5
1 1/2"-8	5/8"	27	5I8ACMETM...028/069	2	22.23	7	TMC25-5 124/004	34.9
1 1/2"-6	5/8"	27	5I6ACMETM...028/070	2	21.17	5	TMC25-5 124/004	33.8
1 3/4"-10	5/8"	27	5I10ACMETM...028/064	2	22.86	9	TMC32-5	41.9
1 3/4"-8	5/8"	27	5I8ACMETM...028/069	2	22.23	7	TMC25-5	41.2
1 3/4"-6	5/8"	27	5I6ACMETM...028/070	2	21.17	5	TMC25-5	40.2
1 3/4"-5	5/8"	27	5I5ACMETM...028/071	2	20.32	4	TMC25-5 124/004	39.3
2"-8	5/8"	27	5I8ACMETM...028/069	2	22.23	7	TMC32-5	47.6
2"-6	5/8"	27	5I6ACMETM...028/072	2	21.17	5	TMC25-5	46.5
2"-5	5/8"	27	5I5ACMETM...028/071	2	20.32	4	TMC25-5	45.7
2 1/4"-6	5/8"	27	5I6ACMETM...028/072	2	21.17	5	TMC32-5	52.9
2 1/4"-5	5/8"	27	5I5ACMETM...028/073	2	20.32	4	TMC25-5	52.0
2 1/2"-5	5/8"	27	5I5ACMETM...028/073	2	20.32	4	TMC32-5	58.4

Beispiel Werkzeuganforderung für Gewinde ACME 1 3/4"-5

Bestellnummern: Platte: 5I5ACME VBX 028/071 Trägerkörper: TMC25-5 124/004

Informationen zu Trägerkörpern auf Seite 234.

TR

Innen

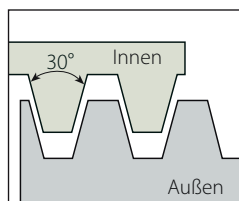

Norm: Trapez DIN 103
 Toleranzklasse: 7e/7H

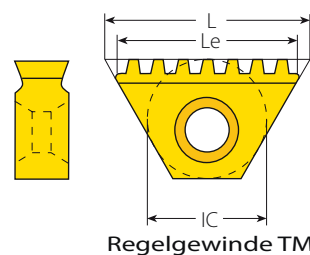

Regelgewinde TM

Gewinde	Plattengröße		Bestellnummer	Schneidkante	Le	Zähne	Trägerkörper	Bohrungsdurchmesserbereich
mm	IC	L mm	Innen		mm			mm
TR 16X2.0	1/4"	11	212.0TRTM...028/028	1	10	5	TMC20-2 124/006	14.0
TR 18X2.0	1/4"	11	212.0TRTM...028/029	1	10	5	TMC20-2 124/006	16.0-18.0
TR 20X2.0	1/4"	11	212.0TRTM...028/029	1	10	5	TMC20-2 124/006	16.0-18.0
TR 24X3.0	1/2"	22	413.0TRTM...028/030	1	18	6	TMC25-4 124/002	21.0
TR 26X3.0	1/2"	22	413.0TRTM...028/031	1	18	6	TMC25-4 124/002	23.0-27.0
TR 28X3.0	1/2"	22	413.0TRTM...028/031	1	18	6	TMC25-4 124/002	23.0-27.0
TR 30X3.0	1/2"	22	413.0TRTM...028/031	1	18	6	TMC25-4 124/002	23.0-27.0
TR 32X3.0	1/2"	22	413.0TRTM...028/032	1	18	6	TMC25-4 124/007	29.0-33.0
TR 34X3.0	1/2"	22	413.0TRTM...028/032	1	18	6	TMC25-4 124/007	29.0-33.0
TR 36X3.0	1/2"	22	413.0TRTM...028/032	1	18	6	TMC25-4 124/007	29.0-33.0
TR 38X3.0	5/8"	27	513.0TRTM...028/033	2	24	8	TMC25-5 124/004	35.0-39.0
TR 40X3.0	5/8"	27	513.0TRTM...028/033	2	24	8	TMC25-5 124/004	35.0-39.0
TR 42X3.0	5/8"	27	513.0TRTM...028/033	2	24	8	TMC25-5 124/004	35.0-39.0
TR 44X3.0	5/8"	27	513.0TRTM...028/033	2	24	8	TMC25-5	41.0-45.0
TR 46X3.0	5/8"	27	513.0TRTM...028/033	2	24	8	TMC25-5	41.0-45.0
TR 48X3.0	5/8"	27	513.0TRTM...028/033	2	24	8	TMC25-5	41.0-45.0
TR 50X3.0	5/8"	27	513.0TRTM...028/033	2	24	8	TMC32-5	47.0-57.0
TR 52X3.0	5/8"	27	513.0TRTM...028/033	2	24	8	TMC32-5	47.0-57.0
TR 55X3.0	5/8"	27	513.0TRTM...028/033	2	24	8	TMC32-5	47.0-57.0
TR 60X3.0	5/8"	27	513.0TRTM...028/033	2	24	8	TMC32-5	47.0-57.0
TR 65X4.0	5/8"	27	514.0TRTM...028/034	2	24	6	TMC32-5	61.0-106.0
TR 70X4.0	5/8"	27	514.0TRTM...028/034	2	24	6	TMC32-5	61.0-106.0
TR 75X4.0	5/8"	27	514.0TRTM...028/034	2	24	6	TMC32-5	61.0-106.0
TR 80X4.0	5/8"	27	514.0TRTM...028/034	2	24	6	TMC32-5	61.0-106.0
TR 85X4.0	5/8"	27	514.0TRTM...028/034	2	24	6	TMC32-5	61.0-106.0
TR 90X4.0	5/8"	27	514.0TRTM...028/034	2	24	6	TMC32-5	61.0-106.0
TR 95X4.0	5/8"	27	514.0TRTM...028/034	2	24	6	TMC32-5	61.0-106.0
TR 100X4.0	5/8"	27	514.0TRTM...028/034	2	24	6	TMC32-5	61.0-106.0
TR 105X4.0	5/8"	27	514.0TRTM...028/034	2	24	6	TMC32-5	61.0-106.0
TR 110X4.0	5/8"	27	514.0TRTM...028/034	2	24	6	TMC32-5	61.0-106.0

Beispiel Werkzeuganforderung für Gewinde TR 38x3.0

Bestellnummer: Platte: **513.0TRTM VBX 028/033** Trägerkörper: **TMC25-5 124/004**

Informationen zu Trägerkörpern auf Seite 234.



Gewindefräsen



> Standard
Trägerkörper

Gewindefräsen Trägerkörper

■ Vardex Bestellnummernsystem.....	Seite 234
■ Standard Fräferschaft TM.....	Seite 235
■ Fräferschaft lange Ausführung TML.....	Seite 236
■ Fräferschaft für Innenregelgewinde 124/.....	Seite 237
■ Konisches Gewinde (NPT, NPTF, BSPT) Fräferschaft TMN.....	Seite 237
■ Doppelsitzschaft TM2.....	Seite 238
■ Doppelsitzschaft (Platten versetzt) TMO.....	Seite 239
■ Standard TM Einzahngewindefräser TMS.....	Seite 240
■ TM Fräferschaft für vertikale Platten TMV.....	Seite 240
■ TM Fräskopf.....	Seite 241
■ Ersatzteile für VARDEX TM und TMSH Fräferschäfte.....	Seite 242

Vardex Bestellnummernsystem

Gewindefräsen Fräferschäfte

B	TM	N	C	20	-	3	B		LH	
1	2	3	4	5		6	7	8	9	10
1 - Schaft		2 - System			3 - Halter				4 - Kühlung	
B - Antivibrationssystem		TM - Gewindefräsen			2 - Doppelsitz M - Mini L - Lange Ausführung N - Konischer Halter V - Vertikaler Halter S - Einzahn O - Versetzt W - Breiter Schnittdurchmesser				C - Kühlkanal	
5 - Spannflächendurchmesser		6 - Plattengröße		7 - Schneidkantenlänge		9 - RH / LH - Halter				
10, 12, 16, 20, 25, 32, 40		6,0 - 6,0mm 2 - 1/4" 3 - 3/8" 3B - 3/8"B 4 - 1/2" 5 - 5/8" 6B - 3/4"B		B - TMB		Leer - Rechtes Werkzeug LH - Linkes Werkzeug				
				8 - Seriennummer.		10 - Seriennummer.				
				(für TMO- Halter) 1 - 16		(für Regelgewinde- Halter) 124/...				

Gewindefräsen Fräsköpfe

TMSH	-	D63	-	22	-	3	B
1		2		3		4	5
1 - System		2 - Fräsdurchmesser		3 - Aufnahmebohrungsdurchmesser		4 - Plattengröße	
Thread Mill Shell Mill		38, 50, 63, 80, 100, 125		16, 22, 27, 32, 40		2 - 1/4" 3 - 3/8" 3B - 3/8"B 5 - 5/8" 6B - 3/4"B	
5 - Schneidkantenlänge							
B - TMB							



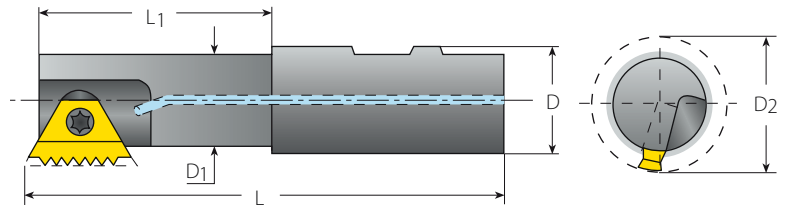

Fräuserschäfte zur Aussen- und Innenbearbeitung



TM Standard

Ersatzteile

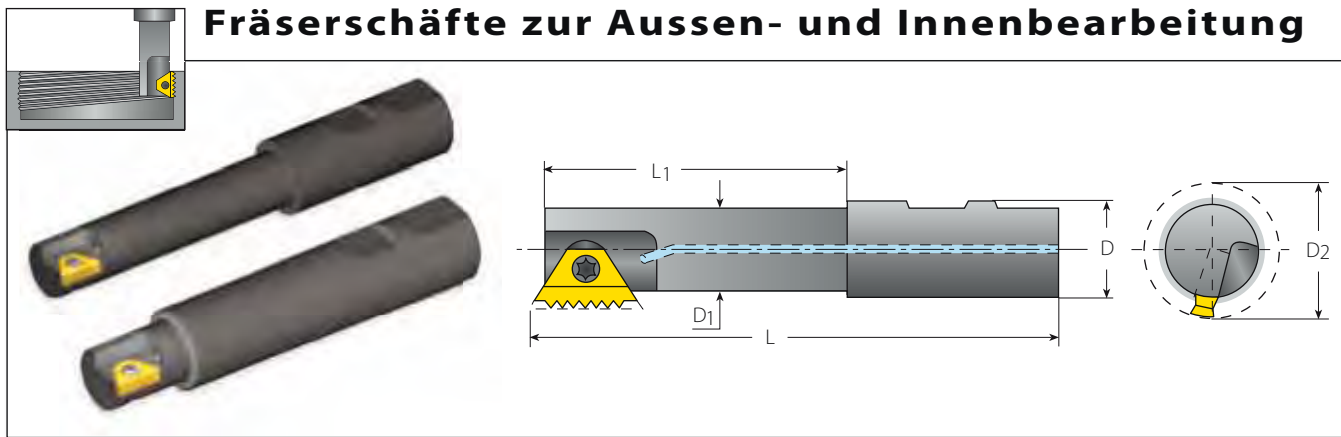

Plattengröße	Bestellnummer	Abmessungen mm						
IC		L	L1	D	D1	D2	Klemmschraube	Torx Schlüssel
6.0mm	TMMC12-6.0	69.0	12.0	12	6.8	9.0	SN7T	K7T
	TMMC20-6.0	84.0	17.0	20	6.8	9.0		
1/4"	TMC12-2	70.0	12.0	12	8.9	11.5	SN2TM	K2T
	TMC20-2	85.0	20.0	20	8.9	11.5		
3/8"	TMC16-3	90.0	22.0	16	13.6	17.0	SN3TM	K3T
	TMC20-3	95.0	43.0	20	16.6	20.0		
3/8"B	BTMC16-3B	79.5	29.0	16	13.5	17.0	SN3TM	K3T
	BTMC20-3B	81.5	29.0	20	15.5	19.0		
	BTMC25-3B	92.3	30.0	25	15.5	19.0		
	BTMWC25-3B	90.8	30.0	25	18.5	22.0		
5/8"	TMC25-5	110.0	52.0	25	24.0	30.0	SN5TM	K5T
	TMC25-5LH	110.0	52.0	25	24.0	30.0		
	TMC32-5	120.0	58.0	32	31.0	37.0		
3/4"B	TMC32-6B	115.0	53.0	32	27.0	35.0	SM7T	K30T
	TMC40-6B	135.0	63.0	40	38.0	46.0		

Bestellbeispiel: TMC12-2



TML- Fräuserschäfte lange Ausführung

Ersatzteile

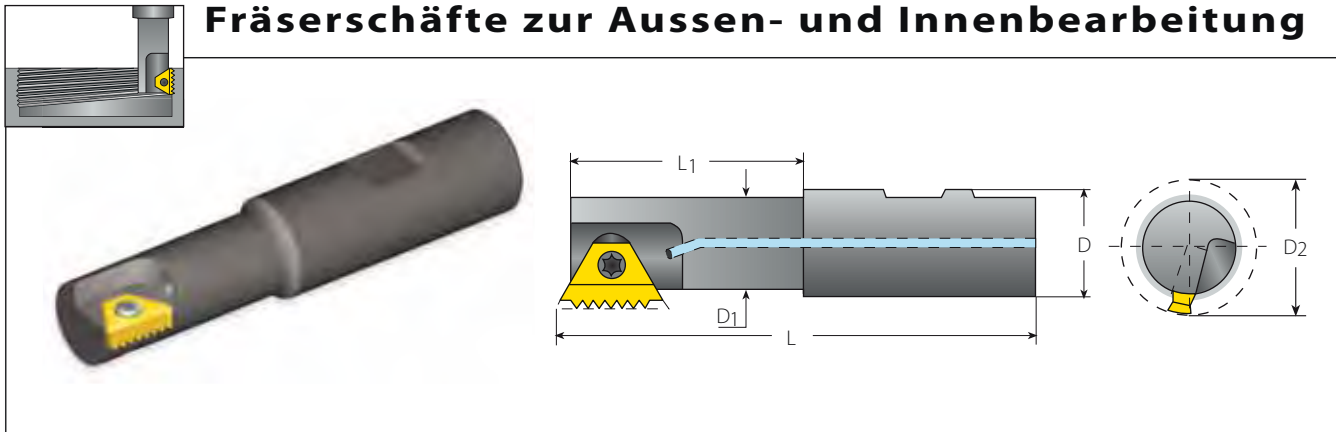

Plattengröße	Bestellnummer	Abmessungen mm					Ersatzteile	
		L	L1	D	D1	D2		
1/4"	TMLC25-2	125.0	17.0	25	8.9	11.5	SN2TM	K2T
3/8"	TMLC25-3	125.0	25.0	25	18.6	22.0	SN3T	K3T
	BTMLC25-3	125.0	63.5	25	18.6	22.0		
3/8"B	BTMLC20-3B	96.5	44.0	20	15.5	19.0	SN3T	K3T
	BTMLC25-3B	125.0	63.5	25	18.6	22.0		
5/8"	TMLC25-5	150.0	92.0	25	24.0	30.0	SN5TM	K5T
	TMLC32-5	160.0	98.0	32	31.0	37.0		
3/4"B	TMLC40-6B	165.0	93.0	40	38.0	46.0	SM7T	K30T

Bestellbeispiel: TMLC25-3



124/.. – für Innenregelgewinde

Ersatzteile

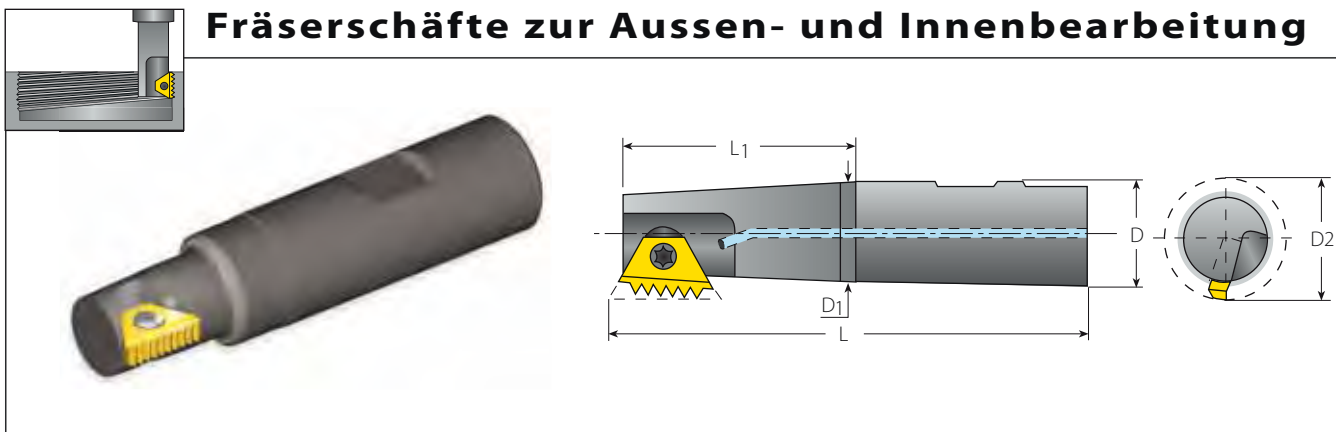

Plattengröße	Bestellnummer	Abmessungen mm						
IC		L	L1	D	D1	D2	Klemmschraube	Torx Schlüssel
6.0mm	TMMC20-6.0 124/003	85	15.0	20	6.7	9.0	SN7T	K7T
1/4"	TMC20-2 124/005	77	15.5	20	7.4	10.0	SN2TM	K2T
	TMC20-2 124/006	77	15.5	20	9.0	12.0		
	TMC20-2 124/009	77	15.5	20	7.4	10.0		
3/8"	TMC16-3 124/001	91	20.5	16	12.2	15.5	SN3TM	K3T
1/2"	TMC25-4 124/002	88	30.0	25	13.4	18.0	SN4TM	K4T
	TMC25-4 124/007	98	40.0	25	16.0	20.0	SA4TM	K4T
5/8"	TMC25-5 124/004	98	40.0	25	19.0	25.0	SA5TM	K5T
	TMC25-5 124/008	98	40.0	25	16.4	22.0	SN5TM	K5T

Bestellbeispiel: TMMC 20-6 124/003



TMN – Für konische Gewinde (NPT, NPTF, BSPT)

Ersatzteile

Plattengröße	Bestellnummer		Abmessungen mm						
IC	RH	LH	L	L1	D	D1	D2	Klemmschraube	Torx Schlüssel
3/8"	TMNC16-3	TMNC16-3 LH	90.0	22.0	16	12.5	15.5	SN3TM	K3T
	TMNC20-3	TMNC20-3 LH	85.0	23.0	20	15.0	19.0		
3/8"B	BTMNC16-3B	BTMNC16-3B LH	79.5	29.0	16	13.5	17.0	SN3TM	K3T
	BTMNC20-3B	BTMNC20-3B LH	81.5	29.0	20	15.5	19.0		
5/8"	TMNC32-5	TMNC32-5 LH	120.0	58.0	32	31.0	37.0	SN5TM	K5T

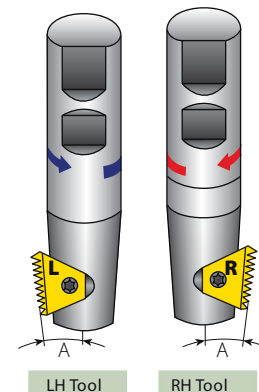

Bestellbeispiel: TMNC20-3

HINWEIS: Mit "L" markierte Schneidkanten erfordern einen LH- Fräsenkörper.

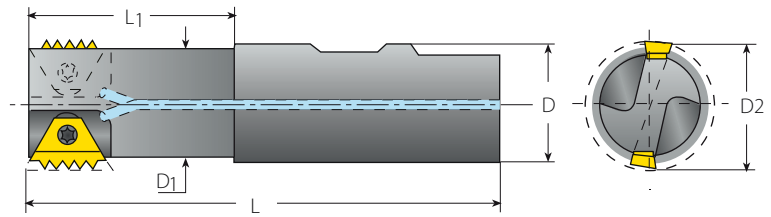
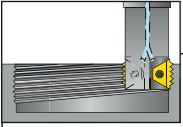

Fügen Sie bitte LH zur Bestellnummer hinzu.

Frärschäfte zur Aussen- und Innenbearbeitung



TM2 - Doppelsitz Frärschaft

Ersatzteile

Plattengröße	Bestellnummer	Abmessungen mm						
IC		L	L1	D	D1	D2	Klemmschraube	Torx Schlüssel
1/4"	TM2C20-2	85	20.0	20	14.4	17	SN2TM	K2T
3/8"	TM2C25-3	100	43.0	25	22.5	26	SN3T	K3T
3/8"B	BTM2C25-3B	104.2	46.0	25	22.5	26	SN5TM	K5T
5/8"	TM2C32-5	120	45.0	32	36.0	42	SM7T	K30T
3/4"B	TM2C40-6B	137.2	65.0	40	44.0	52		

Bestellbeispiel: **TM2C32-5**

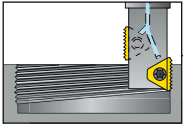

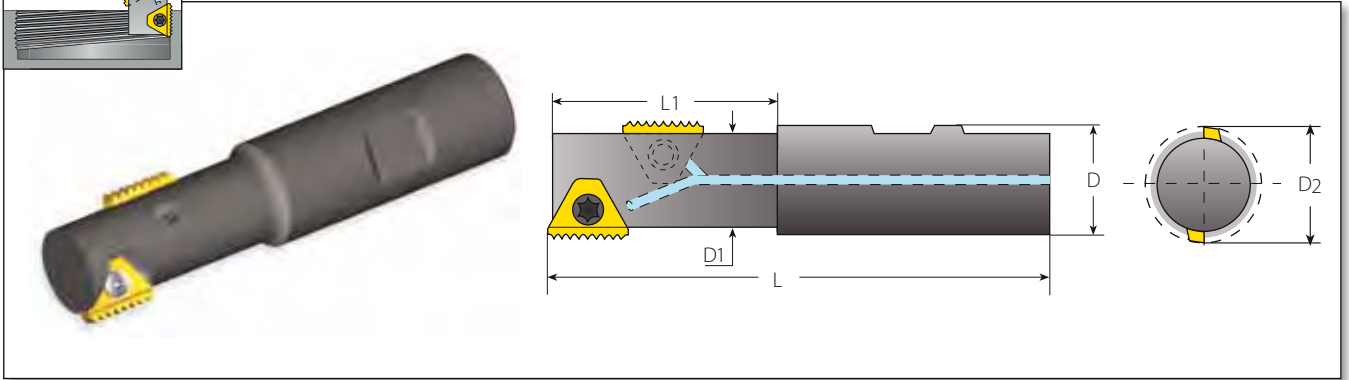

Fräuserschäfte zur Aussen- und Innenbearbeitung



Gewindefräsplatten
Trägerkörper

TMO – Doppelsitz Fräuserschaft (versetzt)

Ersatzteile Parts

Wendeplatte Grösse	Bestellnummer	für die Bearbeitung von			Abmessungen mm						
IC	Außen	Innen	Außen & Innen	L	L1	D	D1	D2	Klemmschraube	Torx Schlüssel	
1/4"	TMOC20-2-1	16UN	48/32/16UN		90	25	20	11.9	14.5	SN2TM	K2T
	TMOC20-2-2	24/18UN	48/24/18UN	24W							
	TMOC20-2-3	28/14UN	28/14UN	28/14W							
	TMOC20-2-4	20UN	20UN								
	TMOC20-2-5			26W							
	TMOC20-2-6			20W							
	TMOC20-2-7			19W							
	TMOC20-2-8	1.0/1.5ISO	0.5/1.0/1.5ISO								
	TMOC20-2-9	0.75ISO	48UN, 0.75ISO								
	TMOC20-2-10	1.25ISO	1.25ISO								
3/8"	TMOC20-3-1	1.5ISO	0.5/1.5ISO		95	43	20	16.6	20	SN3T	K3T
	TMOC20-3-2	13UN	13UN	26W							
	TMOC20-3-3	28UN	32/28UN								
	TMOC20-3-4	27UN	27UN								
	TMOC20-3-5		11.5UN	11.5NPS							
	TMOC20-3-6	24/20/18/16/14/12UN	24/20/18/16/14/12UN	26/20/18/16/14/12W, 14NPS							
	TMOC20-3-7	1.25ISO	1.25ISO	24W							
	TMOC20-3-8			19W							
	TMOC20-3-9			11W							
	TMOC20-3-10	1.0/2.0ISO	0.5/1.0/2.0ISO								
	TMOC20-3-11	0.75ISO	32UN, 0.75ISO								
	TMOC20-3-12	1.75ISO	1.75ISO								
5/8"	TMOC25-5-1	24/20/18/14/13/12UN	24/20/18/14/13/11UN	14W	110	52	25	24	30	SN5TM	K5T
	TMOC25-5-2	24/18/12UN	24/18/12/6UN	12W							
	TMOC25-5-3	16UN	16UN	16W, 8NPS							
	TMOC25-5-4	14/7UN	14UN	14/7W							
	TMOC25-5-5		11.5UN	11.5NPS							
	TMOC25-5-6	11UN	11UN	11W							
	TMOC25-5-7	10UN	10/5UN	10W							
	TMOC25-5-8	9UN	9UN	9W							
	TMOC25-5-9	8UN	8UN	8W							
	TMOC25-5-10		7UN								
	TMOC25-5-11	6UN		6W							
	TMOC25-5-12	1.0/2.0/2.5/4.0ISO	1.0/2.0/2.5/4.0/5.0ISO								
	TMOC25-5-13	1.25ISO	1.25ISO								
	TMOC25-5-14	1.5/2.5/4.5ISO	1.5/2.5/4.5/ISO								
	TMOC25-5-15	1.75ISO	1.75ISO								
	TMOC25-5-16	1.0/1.5/3.0/3.5ISO	1.0/1.5/3.0/3.5ISO								

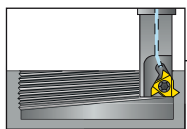

Fräuserschäfte zur Aussen- und Innenbearbeitung

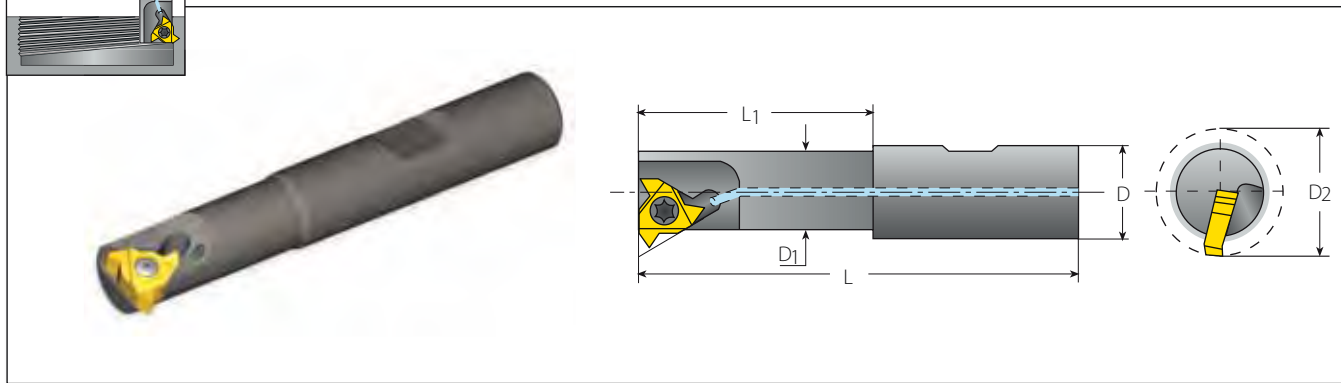

TMS - Einzahn Fräuserschaft (Standard Platten)

Spare Parts

Plattengröße	Bestellnummer	Abmessungen mm					Spare Parts	
IC	L	L1	D	D1	D2	Klemmschraube	Torx Schlüssel	
1/4"	TMSC10-2	65	25	10	9.3	12.5	SN2T8	K2T

Bestellbeispiel: **TMSC10-2**

HINWEIS: Verwenden Sie Standard Gewindefrässlatten. Siehe Abschnitt Gewindefrässlatten, Seite 18.

Verwenden Sie Aussen- Linksplatten für Aussengewinde und Innen- Rechtsplatten für Innengewinde.

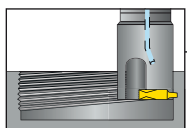

Fräuserschäfte zur Aussen- und Innenbearbeitung

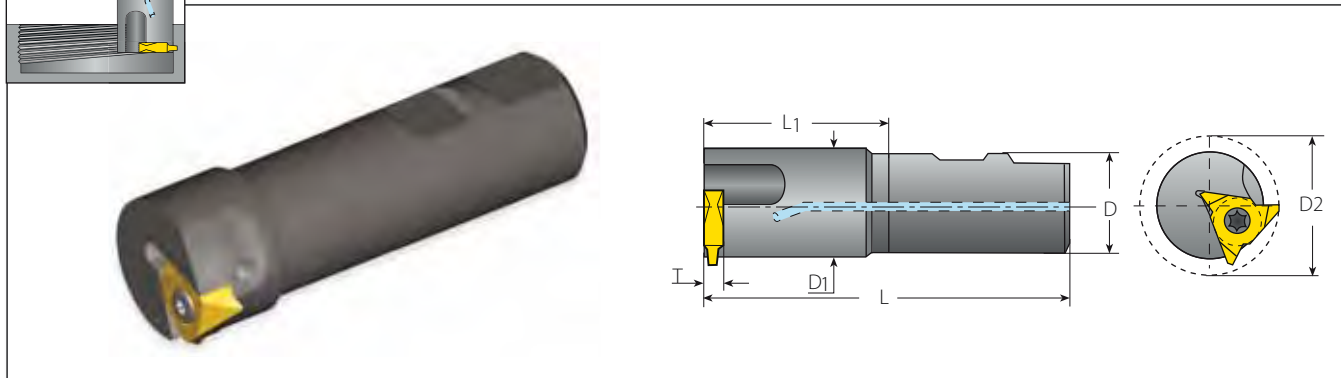

TMS - Einzahn Fräuserschaft (Vertikale Platten)

Spare Parts

Plattengröße	Bestellnummer	Abmessungen mm					Spare Parts	
IC	L	L1	D	D1	D2	Klemmschraube	Torx Schlüssel	
5/8"V	TMVC32-5	120	60	32	35.6	46	SN6T	K6T

Bestellbeispiel: **TMVC32-5**

HINWEIS: IC 5/ 8" vertikale Gewindefrässlatten (Breite T= 6) erforderlich. Verwenden Sie Aussen- Linksplatten für Aussengewinde und Innen- Rechtsplatten für Innengewinde.

Siehe Abschnitt Gewindefrässlatten, Seite 18.

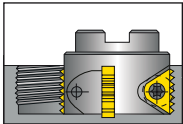

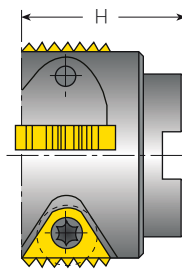
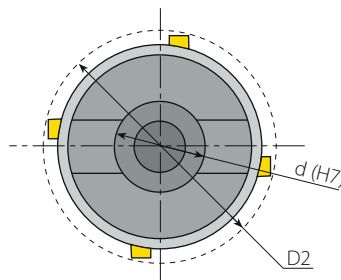

Fräskopf zur Aussen- und Innenbearbeitung



Aufnahme
ISO 240-1975 (mm)

TM Fräsköpfe

Ersatzteile

Plattengröße	Bestellnummer	Anzahl der Platten	Abmessungen mm			Ersatzteile		
			D2	d(H7)	H			
1/4"	TMSH-D38-16-2	6	38.0	16.0	40.0	SN2T	HK2T	M8X1.25X35
1/4"	TMSH-D50-22-2	8	50.0	22.0	40.0			M10X1.50X35
3/8"	TMSH-D50-22-3	6	50.0	22.0	40.0	SN3TM	HK3T	M10X1.50X35
3/8B"	TMSH-D63-22-3B	6	63.0	22.0	40.0			M10X1.50X35
5/8"	TMSH-D63-22-5	4	63.0	22.0	45.0	SN5TM	HK5T	M10X1.50X35
3/4B"	TMSH-D63-22-6B	4	63.0	22.0	50.0	SM7T	HK7T	M10X1.50X35
5/8"	TMSH-D80-27-5	6	80.0	27.0	50.0	SN5TM	HK5T	M12X1.75X40
3/4B"	TMSH-D80-27-6B	5	80.0	27.0	50.0	SM7T	HK7T	M12X1.75X40
5/8"	TMSH-D100-32-5	7	100.0	32.0	55.0	SN5TM	HK5T	M16X2.00X40
3/4B"	TMSH-D100-32-6B	6	100.0	32.0	55.0	SM7T	HK7T	M16X2.00X40
5/8"	TMSH-D125-40-5	9	125.0	40.0	63.0	SN5TM	HK5T	M20X2.50X50
3/4B"	TMSH-D125-40-6B	8	125.0	40.0	63.0	SM7T	HK7T	M20X2.50X50

Ersatzteile Für VARDEX TM und TMSH Trägerkörper



Platte IC



Halter



Aufnahme



Plattenspannschraube



Torx Schlüssel

			Bezeichnung	Gewinde	
6.0mm	TMMC...-6.0		SN7T	M2.2x0.45x5.0	K7T
1/4"	TM.C...-2		SN2TM	M2.6x0.45x5.9	K2T
3/8"	TM.C...-3, TMC...-3 124/...		SN3T, SN3TM	UNC5x9.5, 8.0	K3T
3/8"B	BTM.C...-3B		SN3T	UNC5x.9.5	K3T
1/2"	TMC...-4 124/...		SN4TM, SA4TM	UNC8x10.7, 11.6	K4T
5/8"	TM.C...-5, TMC...-5 124/...		SN5TM, SA5TM	M5x0.8x15.0	K5T
3/4"B	TM.C...-6B		SM7T	M7x1.0x15.0	K30T
1/4"	TMSH-D38-16-2	M8X1.25X35	SN2T	M2.6x0.45x6.5	HK2T
1/4"	TMSH-D50-22-2	M10X1.50X35	SN2T	M2.6x0.45x6.5	HK2T
3/8"	TMSH-D50-22-3	M10X1.50X35	SN3TM	UNC5x8.0	HK3T
3/8"B	TMSH-D63-22-3B	M10X1.50X35	SN3TM	UNC5x8.0	HK3T
5/8"	TMSH-D63-22-5	M10X1.50X35	SN5TM	M5x0.8x15.0	HK5T
3/4"B	TMSH-D63-22-6B	M10X1.50X35	SM7T	M7x1.0x15.0	HK7T
5/8"	TMSH-D80-27-5	M12X1.75X40	SN5TM	M5x0.8x15.0	HK5T
3/4"B	TMSH-D80-27-6B	M12X1.75X40	SM7T	M7x1.0x15.0	HK7T
5/8"	TMSH-D100-32-5	M16X2.00X40	SN5TM	M5x0.8x15.0	HK5T
3/4"B	TMSH-D100-32-6B	M16X2.00X40	SM7T	M7x1.0x15.0	HK7T
5/8"	TMSH-D125-40-5	M20X2.50X50	SN5TM	M5x0.8x15.0	HK5T
3/4"B	TMSH-D125-40-6B	M20X2.50X50	SM7T	M7x1.0x15.0	HK7T



Gewindefräsen



> Technische Daten

Gewindefräsen Technische Daten

■ Über das Gewindefräsen.....	Seite 245
■ Zustellung über tangierenden Bogen und Radiale Zustellung.....	Seite 246
■ Vorbereitung zum Gewindefräsen.....	Seite 247
■ Liste der "G"-Funktionen für das CNC- Programm.....	Seite 248
■ Sorten und ihre Anwendungen.....	Seite 248
■ Empfohlene Schnittgeschwindigkeiten.....	Seite 249
■ Min. Bohrungsdurchmesser zum Gewindefräsen.....	Seite 250
■ Problemlösungen.....	Seite 252

**Weitere technische Daten
finden Sie in unserem TM
Handbuch**

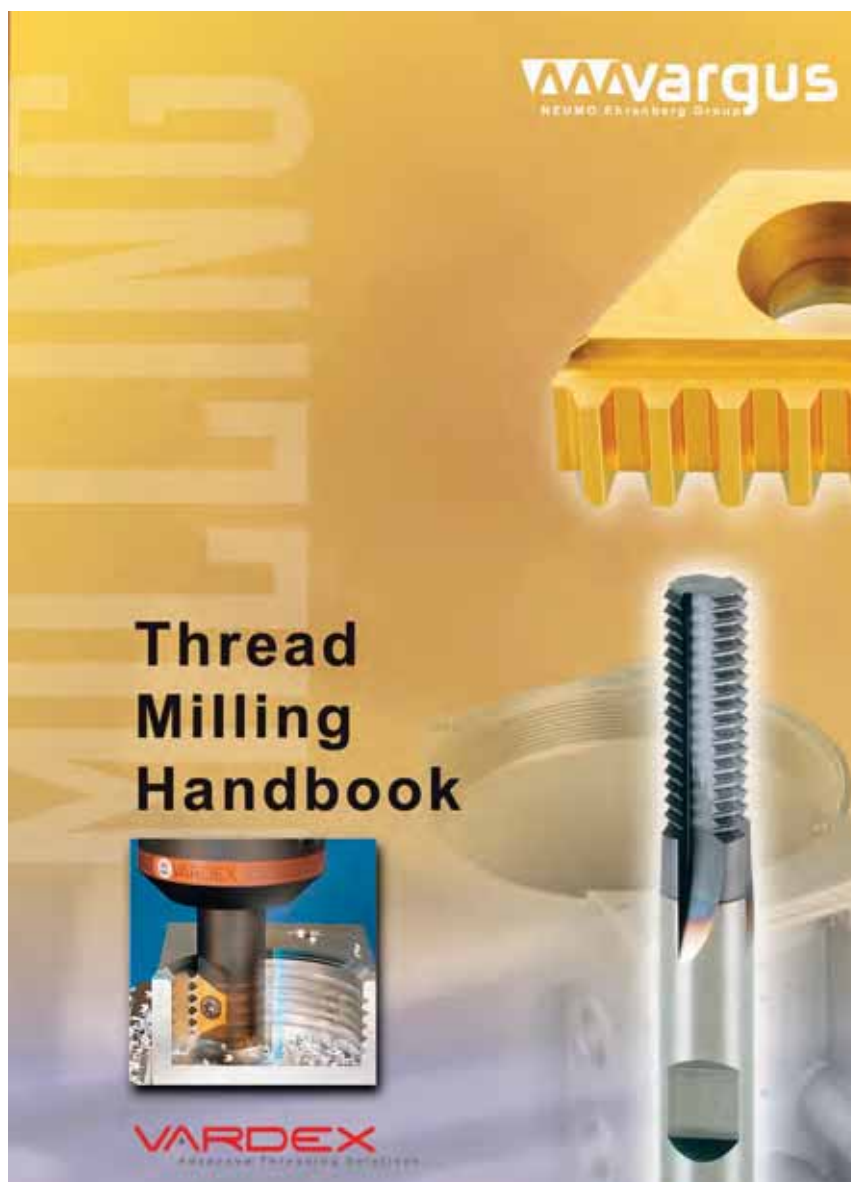

Über das Gewindefräsen

Voraussetzung für das Gewindefräsen ist eine Fräsmaschine mit Dreiachsen- Bahnsteuerung (Helikalinterpolation). Dreiachsen- Bahnsteuerung ist eine CNC- Funktion für die Werkzeugbewegung entlang einer Schraubenlinie. Eine helikale Bewegung setzt sich zusammen aus einer Kreisbewegung in einer Ebene und einer simultanen linearen Bewegung senkrecht zu dieser Ebene, d. h. die Bahn von Punkt A zu Punkt B (Abb. A) kombiniert eine kreisförmige Bewegung in der X/ Y- Ebene mit einer linearen Verschiebung in der Z- Richtung. Auf den meisten CNC- Systemen kann diese Funktion auf zwei Weisen ausgeführt werden:

GO2: Helikalinterpolation im Uhrzeigersinn

GO3: Helikalinterpolation im Gegenuhrzeigersinn



Abb. A



α: Steigungswinkel
D: Außendurchmesser
p: Teilung

Abb. B

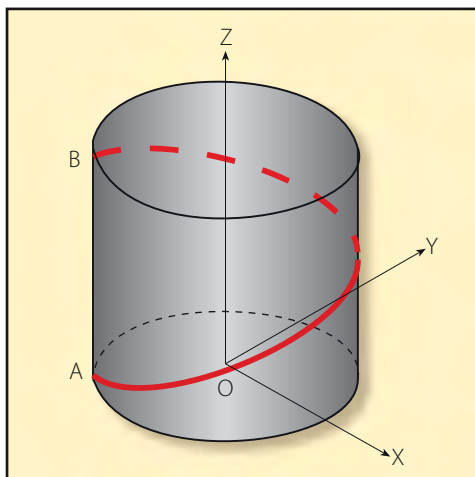
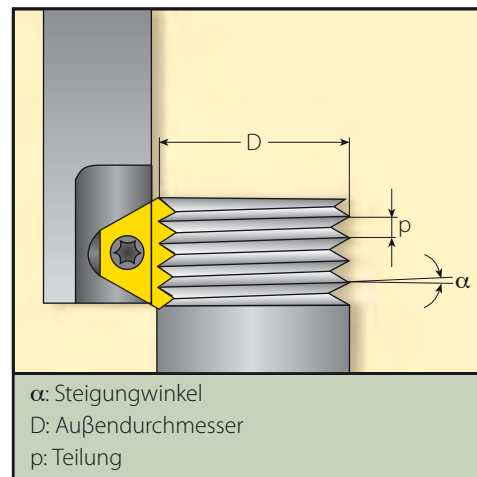
Das Gewindefräsen (Abb. B) besteht aus einer Kreisbewegung des Werkzeugs um seine eigene Achse, zusammen mit einer Umlaufbewegung entlang des Bohrungs- oder Werkstückumfangs.

Während eines solchen Umlaufs wird das Werkstück um eine Teilungslänge vertikal versetzt. Diese Bewegungen erzeugen zusammen mit der Schneidplattengeometrie die gewünschte Gewindeform.

Es gibt drei geeignete Möglichkeiten, den Gewindefräser an das Werkstück heranzuführen:

u Über einen tangierenden Bogen

v Radial

w Über eine tangierende Gerade

U Zustellung über tangierenden Bogen

Bei dieser Methode taucht das Werkzeug sanft in das Werkstück ein und wird ebenso wieder herausgeführt. Selbst bei härteren Werkstoffen entstehen hierbei keine Verweilmarken oder Vibrationen.

Diese Methode verlangt zwar eine etwas aufwendigere Programmierung als die Radialzustellungsmethode (siehe unten), aber sie ist für das Fräsen von Gewinden mit hoher Qualität zu empfehlen.

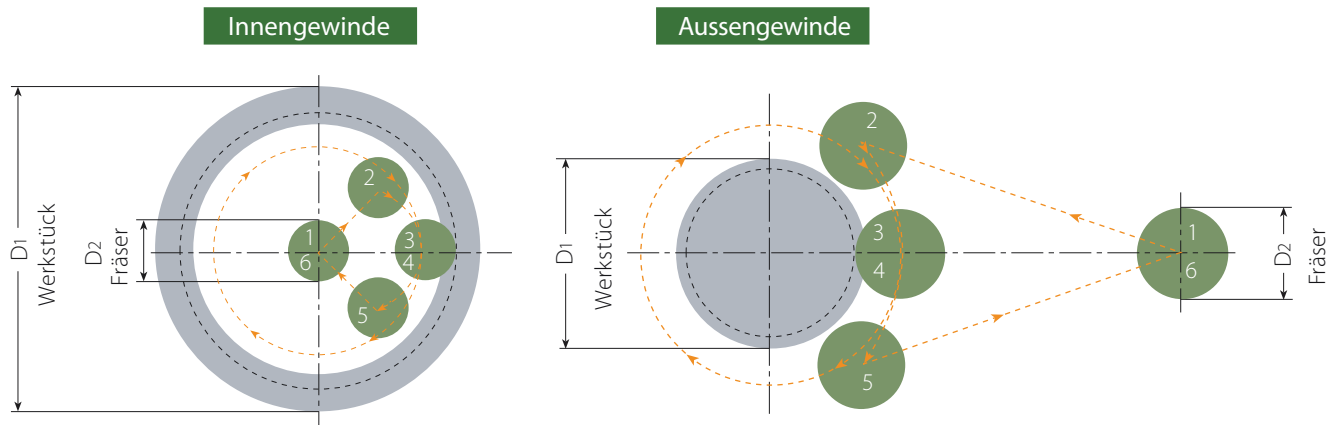

1-2: Eilzustellung

2-3: Eintauchen des Fräasers über tangierenden Bogen, simultaner Vorschub entlang der Z- Achse

3-4: Schraubenbewegung während eines vollen Umlaufs (360°).

4-5: Werkzeugaustritt über tangentialen Bogen, bei gleichem Vorschub entlang der Z- Achse

5-6: Eilrückführung

✓ Radiale Zustellung

Dies ist die einfachste Methode. Dabei sollten zwei Punkte beachtet werden:

A. Eine kleine vertikale Markierung ist am Eintritts- und Austrittspunkt sichtbar. Sie ist für das Gewinde selbst von geringer Bedeutung.

B. Bei Anwendung dieser Methode in sehr harten Werkstoffen können Vibrationen am Werkzeug auftreten, wenn die volle Schnitttiefe erreicht wird.

Hinweis: Der radiale Vorschub während des Eintritts in die volle Profiltiefe sollte nur $\frac{1}{3}$ des nachfolgenden Vorschubs der Kreisbewegung ausmachen!

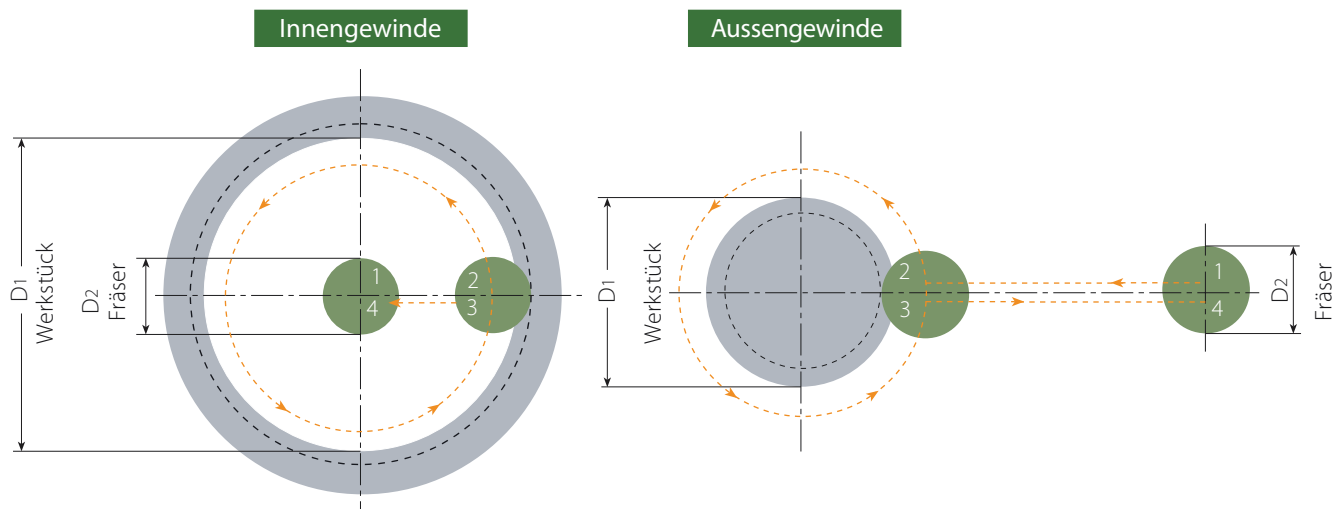

1-2: Radiales Eintauchen

2-3: Schraubenbewegung während eines vollen Umlaufs (360°).

3-4: Radialer Austritt

W Zustellung über eine tangierende Linie

Diese sehr einfache Methode bietet alle Vorteile der Zustellung über einen tangierenden Bogen, ist aber nur bei Aussengewinden anzuwenden.

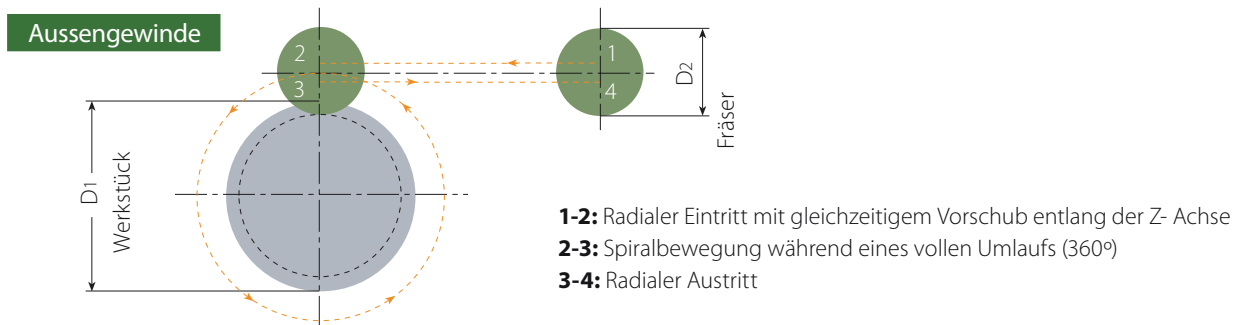

Vorbereitung zum Gewindefräsen

U Berechnung der Drehzahl und des Vorschubs an der Schneidkante

$$n = \frac{1000 \times V_c}{\pi \times D_2}$$

$$V_c = \frac{n \times \pi \times D_2}{1000}$$

$$V_f1 = n \times z \times fz$$

n - Drehzahl [U/Min.]
 Vc - Schnittgeschwindigkeit [m/Min.]
 D2 - Schneidendurchmesser [mm]
 Vf1 - Vorschub an der Schneidkante [mm/min]
 z - Anzahl der Schneiden
 fz - Vorschub pro Zahn und Umdrehung [mm/U]

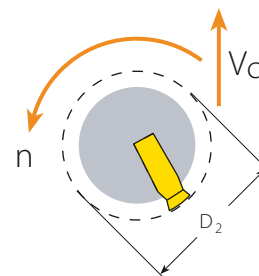

✓ Berechnung des Vorschubs im Werkzeugzentrum

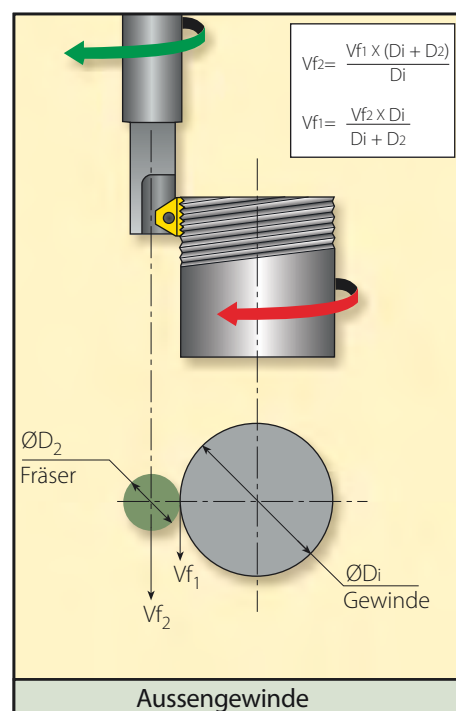
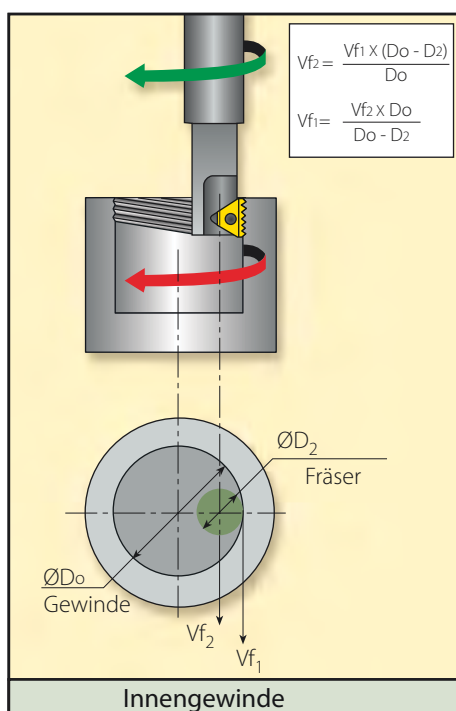



Auf den meisten CNC-Maschinen ist die programmierte Vorschubgeschwindigkeit auf das Zentrum des Werkzeuges ausgerichtet. Bei einer linearen Bewegung sind die Vorschubgeschwindigkeiten im Zentrum und an der Schneidkante identisch, im Falle einer Kreisbewegung entsteht jedoch eine erhebliche Differenz. Die Formeln definieren das Verhältnis zwischen Vorschubgeschwindigkeit an der Schneide und im Zentrum des Werkzeuges.

Liste der "G"- Funktionen (ISO) für das CNC- Programm

Nummer	Beschreibung	Nummer	Beschreibung
%	Code (ISO oder EIA), + Bandende	H	Werkzeuglänge
G00	Positionierung im Eilgang	D	Werkzeugradius
G01	Vorschub	X	X- Achse
G02	Kreisinterpolation im Uhrzeigersinn	Y	Y-Achse
G03	Kreisinterpolation im Gegenuhrzeigersinn	Z	Z-Achse
G40	Aufheben der Werkzeugkorrektur	R	Radius
G41	Werkzeugbahnkorrektur, links	I	Radiusmittelpunkt X- Koordinate
G42	Werkzeugbahnkorrektur, rechts	J	Radiusmittelpunkt Y- Koordinate
G43	Werkzeuglängen +	M3	Spindel dreht im Uhrzeigersinn (CW)
G49	Werkzeugbahnkorrektur löschen	M5	Spindel stop
G57	Nullpunktadresse	M30	Programmende mit Rücksetzen auf Programmanfang
G90	Absolute Massangabe	O	Programm- Nummer
G91	Inkrementale Massangabe	N	Satz- Nummer
F	Vorschub mm/min.	(Start Kommentar
S	Drehzahl U/min.)	Ende Kommentar

Sorten und ihre Anwendungen

Sorte	Anwendung	Beispiel
VBX	Eine zähe Feinkorn Hartmetallsorte mit TiCN- Beschichtung. Bietet gute Bruch- und hervorragende Verschleissfestigkeit.	
VTX	Eine zähe Feinkorn Hartmetallsorte mit TiAlN- Beschichtung. Bietet gute Bruch- und hervorragende Verschleissfestigkeit.	
VK2	Unbeschichtete Hartmetallsorte zum Bearbeiten von Nichteisenmetallen.	

Empfohlene Sorten und Schnittgeschwindigkeiten Vc [m/min] und Vorschübe fz [mm/Zahn]

Materialgruppe	Vardex Nr.	Material	Härte Brinell HB	Vc [m/min]			Vorschub fz [mm/Zahn]	
				Beschichtet		Unbeschichtet	Wendeschneid- platten	
				VBX	VTX	VK2		
P Stahl	1	Unlegierter Stahl	Geringer Kohlenstoffanteil (C=0.1-0.25%)	125	100-210	90-180	0.05-0.3	
	2		Mittlerer Kohlenstoffanteil (C= 0.25- 0.55%)	150	100-180	90-170	0.05-0.25	
	3		Hoher Kohlenstoffanteil (C= 0.55- 0.85%)	170	100-170	90-160	0.05-0.2	
	4	Niedriglegierter Stahl (Legierungs- Elemente ≤ 5%)	Ungehärtet	180	90-160	90-155	0.05-0.25	
	5		Gehärtet	275	80-180	80-160	0.05-0.2	
	6		Gehärtet	350	70-140	70-150	0.05-0.15	
	7	Hochlegierter Stahl (Legierungs- Elemente > 5%)	Vergütet	200	60-130	70-115	0.05-0.2	
	8		Gehärtet	325	70-110	60-100	0.05-0.1	
	9	Stahlguss	Niedriglegiert (Legierungs- Elemente ≤ 5%)	200	100-170	100-170	100-150	0.05-0.15
	10		Hochlegiert (Legierungs- Elemente > 5%)	225	70-120	70-130	60-130	0.05-0.1
M Edelstahl	11	Edelstahl Ferritisch	Ungehärtet	200	100-170	120-180	0.05-0.15	
	12		Gehärtet	330	100-170	120-180	0.05-0.1	
	13	Edelstahl Austenitisch	Austenitisch	180	70-140	100-140	0.05-0.15	
	14		Super- Austenitisch	200	70-140	100-140	0.05-0.1	
	15	Edelstahl	Ungehärtet	200	70-140	100-140	0.05-0.15	
	16		Gehärtet	330	70-140	100-140	0.05-0.1	
	17	Edelstahl Guss austenitisch	Austenitisch	200	70-120	100-120	0.05-0.15	
	18		Gehärtet	330	70-120	100-120	0.05-0.1	
K Gußeisen	28	Temperguss	Ferritisch (kurzspanig)	130	60-130	100-120	0.02-0.8	
	29		Perlitisch (langspanig)	230	60-120	80-100	0.02-0.05	
	30	Grauguss	Niedrigfest	180	60-130	80-100	0.05-0.15	
	31		Hochfest	260	60-100	80-100	0.05-0.1	
	32	Kugelgraphitguss	Ferritisch	160	60-125	80-100	0.05-0.15	
33	Perlitisch		260	50-90	60-90	0.05-0.1		
N(K) Nichteisen- Metalle	34	Aluminium- Legierungen Schmiedeeisen	ungealtert	60	100-250		200-300	0.1-0.4
	35		gealtert	100	100-180		60-110	0.1-0.3
	36	Aluminium- Legierungen	Guß	75	150-400		60-120	0.1-0.3
	37		Guß & gealtert	90	150-280		60-100	0.05-0.25
	38	Aluminium- Legierungen	Guß Si 13- 22%	130	80-150		20-50	0.1-0.3
	39	Kupfer und Kupferlegierungen	Messing	90	120-210	100-200	50-70	0.1-0.3
40	Bronze und bleifreies Kupfer		100	120-210	100-200	50-70	0.05-0.25	
S(M) Hitzebeständige Material	19	Hochtemperaturlegierungen	Vergütet (Eisen basiert)	200	20-45	20-40	20-30	0.05-0.1
	20		Gealtert (Eisen basiert)	280	20-30	20-30	15-25	0.02-0.05
	21		Vergütet (Nickel oder Cobalt basiert)	250	20-50	15-20	15-20	0.02-0.05
	22		Gealtert (Nickel oder Cobalt basiert)	350	10-15	10-15	10-15	0.02-0.05
	23	Titanlegierungen	Reines 99,5 Ti	400Rm	70-140	70-120	40-60	0.02--0.05
24	α+β Legierungen		1050Rm	20-50	20-50	20-40	0.02-0.05	
H(K) Gehärtetes Material	25	Extra harter Stahl	Gehärtet & angelassen	45-50HRc	20-45	20-45		0.01-0.03
	26			51-55HRc	20-45	20-45		0.01-0.02

Empfehlung:

Beim Werkzeugeintritt den Vorschub um 70% niedriger ansetzen als den Gewindeschneidvorschub.

Beispiel:

Gewindeschneidvorschub: 0.3 [mm/Zahn]
Werkzeugeintrittsvorschub: 0.09 [mm/Zahn]

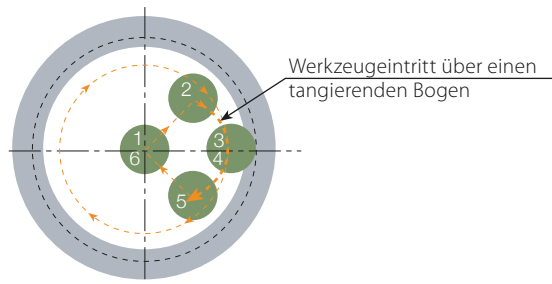

Min. Bohrungsdurchmesser zum Gewindefräsen (Standardsystem)

Teilung mm	0.5	0.6	0.7	0.75 0.80	0.9	1.0	1.25	1.5	1.75	2.0		2.5	3.0	3.5	4.0	4.5	5.0	5.5		6.0		
Teilung G/Z	48	44	36	32	28	26 24	20 19	18 16	14	13 12	11.5 11	10	9 8	7	6		5		4.5			4
Fräaserschaft Bestellnummer	D2	Min. Bohrungsdurchmesser Di mm																				
TMMC 12-6.0	9.0	9.5	9.7	9.9	10.0	10.4	10.7	11.4	12.0													
TMMC 20-6.0	9.0	9.5	9.7	9.9	10.0	10.4	10.7	11.4	12.0													
TMMC 20-6.0 124/003	9.0	9.5	9.7	9.9	10.0	10.4	10.7	11.4	12.0													
TMC 12-2	11.5	12.0	12.2	12.4	12.5	12.9	13.2	13.9	14.5	15.1												
TMC 20-2	11.5	12.0	12.2	12.4	12.5	12.9	13.2	13.9	14.5	15.1												
TMLC 25-2	11.5	12.0	12.2	12.4	12.5	12.9	13.2	13.9	14.5	15.1												
TMSC 10-2	12.5	13.0	12.6	13.6	13.5	13.9	14.2	14.9	15.5	16.1												
TMOOC 20-2	14.5	15.1	15.2	15.3	15.4	16.0	16.4	17.0	17.8	18.6												
TMNC 16-3	15.5	16.0	16.2	16.4	16.5	16.9	17.2	17.9	18.5	19.0	19.5	20.0										
TMC 16-3 124/001	15.5	16.0	16.2	16.4	16.5	16.9	17.2	17.9	18.5	19.0	19.5	20.0										
TMC 16-3	17.0	17.6	17.8	18.0	18.2	18.7	19.0	19.6	20.0	20.5	21.0	21.5										
BTMC 16-3B	17.0	17.6	17.8	18.0	18.2	18.7	19.0	19.6	20.0	20.5	21.0	21.5										
TM2C 20-2	17.0	17.6	17.8	18.0	18.2	18.7	19.0	19.6	20.0	20.5												
BTMC 20-3B	19.0	19.7	20.0	20.2	20.4	20.8	21.0	21.6	22.0	22.5	23.0	23.5										
TMNC 20-3	19.0	19.7	20.0	20.2	20.4	20.8	21.0	21.6	22.0	22.5	23.0	23.5										
TMC 20-3	20.0	20.7	21.0	21.2	21.4	21.8	22.0	22.6	23.0	23.5	24.0	24.5										
TMOOC 20-3	20.0	20.7	21.0	21.2	21.4	21.8	22.0	22.6	23.0	23.5	24.0	24.5										
BTMWC 25-3B	22.0	22.7	23.0	23.2	23.4	23.8	24.0	24.6	25.0	25.5	26.0	26.5										
BTMLC 25-3B	22.0	22.7	23.0	23.2	23.4	23.8	24.0	24.6	25.0	25.5	26.0	26.5										
TMLC 25-3	22.0	22.7	23.0	23.2	23.4	23.8	24.0	24.6	25.0	25.5	26.0	26.5										
TMC 25-5 124/004	25.0	25.7	26.0	26.2	26.4	26.8	27.0	27.7	28.2	28.7	29.2	29.7	31.3	33.7	36.7	39.7	42.7					
TM2C 25-3	26.0	26.7	27.0	27.2	27.4	27.8	28.0	28.7	29.3	29.8	30.3	30.8										
BTM2C 25-3B	26.0	26.7	27.0	27.2	27.4	27.8	28.0	28.7	29.3	29.8	30.3	30.8										
TMC 25-5	30.0	30.7	31.0	31.2	31.4	31.8	32.0	32.8	33.5	34.1	34.6	35.6	36.6	39.0	42.0	45.0	48.0					
TMLC 25-5	30.0	30.7	31.0	31.2	31.4	31.8	32.0	32.8	33.5	34.1	34.6	35.6	36.6	39.0	42.0	45.0	48.0					
TMOOC 25-5	30.0	30.7	31.0	31.2	31.4	31.8	32.0	32.8	33.5	34.1	34.6	35.6	36.6	39.0	42.0	45.0	48.0					
TMC 32-6B	35.0								38.5	39.1	39.6	40.6	42.0	44.0	47.0	50.0	53.4	42.5	50.0	44.6	57.5	56.6
TMC 32-5	37.0	38.0	38.2	38.4	38.6	39.1	39.5	40.4	41.0	41.5	42.0	43.0	44.0	46.5	49.0	52.0	55.5					
TMLC 32-5	37.0	38.0	38.2	38.4	38.6	39.1	39.5	40.4	41.0	41.5	42.0	43.0	44.0	46.5	49.0	52.0	55.5					
TMNC 32-5	37.0	38.0	38.2	38.4	38.6	39.1	39.5	40.0	41.0	41.5	42.0	43.0	44.0	46.5	49.0	52.0	55.5					
TMSH D38-16-2	38.0	38.5	38.7	38.9	39.0	39.6	40.0	41.0	42.0	43.0												
TM2C 32-5	42.0	43.2	43.4	43.6	43.8	44.5	45.0	46.0	46.5	47.0	47.4	48.2	49.0	52.0	54.5	57.5	61.0					
TMVC 32-5	46.0																				62.5	
TMC 40-6B	46.0								49.5	50.1	50.6	51.6	53.0	55.0	55.2	55.6	55.0	52.5	54.0	54.5	57.5	56.6
TMLC 40-6B	46.0								49.5	50.1	50.6	51.6	53.0	55.0	55.2	55.6	55.0	52.5	54.0	54.5	57.5	56.6
TMSH D50-22-2	50.0	50.5	50.7	50.9	51.0	51.6	52.0	53.0	54.0	54.5												
TMSH D50-22-3	50.0	50.5	50.7	50.9	51.0	51.6	52.0	53.0	54.0	54.5	55.0	55.5										

Gewindefräsen
Technische - Daten

Min. Bohrungsdurchmesser zum Gewindefräsen (Standardsystem) (Forts.)

Teilung mm	0.5	0.6	0.7	0.75 0.80	0.9	1.0	1.25	1.5	1.75	2.0		2.5	3.0	3.5	4.0	4.5	5.0	5.5		6.0		
Teilung G/Z	48	44	36	32	28	26 24	20 19	18 16	14	13 12	11.5 11	10	9 8	7	6		5			4.5		4
Fräseschaft Bestellnummer	D2	Min. Bohrungsdurchmesser Di mm																				
TM2C 40-6B	52.0								56.0	56.2	56.5	57.0	59.0	61.5		63.0	64.0	66.0	67.0	67.6	69.0	70.0
TMSH D63-22-3B	63.0	63.5	63.7	63.9	64.0	64.6	65.0	66.0	67.0	67.5	68.0	69.0										
TMSH D63-22-5	63.0	63.5	63.7	63.9	64.0	64.6	65.0	66.0	67.0	67.5	68.0	69.0	70.0	72.0	73.0	74.0	75.0					
TMSH D63-22-6B	63.0								67.0	67.5	68.0	69.0	70.0	72.0	73.0	74.0	75.0	77.0	78.0	78.6	80.0	81.0
TMSH D80-27-5	80.0	80.5	80.7	80.9	81.0	81.6	82.0	83.0	84.0	84.5	85.0	86.0	87.0	89.0	90.0	91.0	92.0					
TMSH D80-27-6B	80.0								84.0	84.5	85.0	86.0	87.0	89.0	90.0	91.0	92.0	94.0	95.0	95.6	97.0	98.0
TMSH D100-32-5	100.0	100.5	100.7	100.9	101.0	101.6	102.0	103.0	104.0	104.5	105.0	106.0	107.0	109.0	110.0	111.0	112.0					
TMSH D100-32-6B	100.0								104.0	104.5	105.0	106.0	107.0	109.0	110.0	111.0	112.0	114.0	115.0	115.6	117.0	118.0
TMSH D125-40-5	125.0	125.5	125.7	125.9	126.0	126.6	127.0	128.0	129.0	129.5	130.0	131.0	132.0	134.0	135.0	136.0	137.0					
TMSH D125-40-6B	125.0								129.0	129.5	130.0	131.0	132.0	134.0	135.0	136.0	137.0	139.0	140.0	140.6	142.0	143.0

Werkzeug für Regelgewinde:

Diese Tabelle ist nicht auf das Regelgewindesystem, mit welchem Bohrungen kleiner als oben aufgelistet gefräst werden können, anzuwenden.
Abschnitt Regelgewinde der verschiedenen Gewindestandards.

Problemlösung

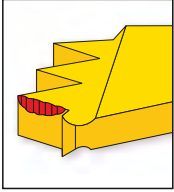
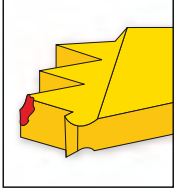
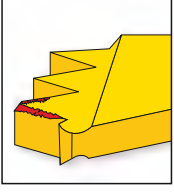
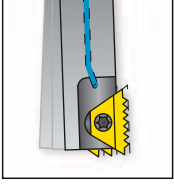
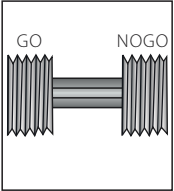
	Problem	Mögliche Ursache	Lösung
	Zu schneller Freiflächenverschleiss	Schnittgeschwindigkeit zu hoch -----> Spandicke zu gering -----> Kühlung ungenügend ----->	- Schnittgeschwindigkeit verringern / beschichtete Wendeplatte verwenden - Vorschubgeschwindigkeit erhöhen - Kühlmittelzufluss steigern
	Ausbröckelung	Spandicke zu gross -----> Vibration ----->	- Vorschubgeschwindigkeit reduzieren / Drehzahl ändern / erhöhen - Stabilität überprüfen
	Aufbauschnaide	Falsche Schnittgeschwindigkeit -----> Ungeeignete Hartmetallsorte ----->	Schnittgeschwindigkeit ändern Verwenden Sie eine beschichtete Hartmetallsorte
	Rattermarken / Vibration	Tischvorschub zu hoch -----> Profiltiefe zu gross -----> Gewinde zu lang ----->	Vorschub reduzieren Zwei Durchgänge vornehmen, jeweils mit erhöhter Schnitttiefe/ Zwei Durchgänge vornehmen und jeweils nur die halbe Länge des Gewindes schneiden Zwei Durchgänge vornehmen und jeweils nur die halbe Länge des Gewindes schneiden
	Ungenügende Genauigkeit	Werkzeugablenkung ----->	Vorschubgeschwindigkeit reduzieren "Null-Schnitt" fahren



MiTM

Multi-Flute indexable Thread Milling

- > Schneidplatten
- > Trägerkörper
- > Technische Daten



- Vardex Bestellnummernsystem.....Seite 256

Schneidplatten

- ISO metrisch.....Seite 257
- American UN.....Seite 258
- NPT.....Seite 259
- NPTF.....Seite 259
- Whitworth für BSF, BSP.....Seite 260
- BSPT.....Seite 261

Trägerkörper

- Standardträgerkörper(MiTM 24).....Seite 262
- Konische Trägerkörper(MiTM 24).....Seite 263
- Standardträgerkörper(MiTM 25).....Seite 264
- Konische Trägerkörper(MiTM 25).....Seite 265
- Fräsköpfe (MiTM 25).....Seite 266
- Standardträgerkörper(MiTM 40).....Seite 267
- Fräsköpfe (MiTM 40).....Seite 268
- Standardträgerkörper(MiTM 41).....Seite 269
- Fräsköpfe (MiTM 41).....Seite 270

Technische Daten

- Empfohlene Schnittgeschwindigkeiten und Zahnvorschübe.....Seite 271



Downloads der TM Gen Software und Updates unter www.vargus.de

VARDEX MiTM (Multi-flute Indexable Thread Mill) verkürzt die Bearbeitungszeit bei der Herstellung von Gewinden mit langen Schneidplatten und einer großen Auswahl an Haltertypen.

MiTM 24 (M)

Für kleine Bohrungen



Zähnezahl (Z) 1-2
Schneidendurchmesser (D2) 13.6-16
nutzbare Einsatztiefe (L1) 26-36



Zähnezahl (Z) 1
Schneidendurchmesser (D2) 13.9
nutzbare Einsatztiefe (L1) 26

MiTM 25 (S)

Für Standardanwendungen



Zähnezahl (Z) 2-5
Schneidendurchmesser (D2) 17-30
nutzbare Einsatztiefe (L1) 26-80



Zähnezahl (Z) 2-4
Schneidendurchmesser (D2) 17-28
nutzbare Einsatztiefe (L1) 26-43



Zähnezahl (Z) 5-8
Schneidendurchmesser (D2) 36-52
nutzbare Einsatztiefe (L1) max.200



Zähnezahl (Z) 5
Schneidendurchmesser (D2) 36
nutzbare Einsatztiefe (L1) max.200

MiTM 40 (L)

Für lange Gewinde



Zähnezahl (Z) 3-4
Schneidendurchmesser (D2) 22-30
nutzbare Einsatztiefe (L1) 43-80



Zähnezahl (Z) 6-8
Schneidendurchmesser (D2) 44-52
nutzbare Einsatztiefe (L1) max.200



Zähnezahl (Z) 6
Schneidendurchmesser (D2) 45
nutzbare Einsatztiefe (L1) max.200

MiTM 41 (B)

Für grosse Teilungen



Zähnezahl (Z) 2-5
Schneidendurchmesser (D2) 24.5-36
nutzbare Einsatztiefe (L1) 43-65



Zähnezahl (Z) 5-6
Schneidendurchmesser (D2) 48-58
nutzbare Einsatztiefe (L1) max.200

MiTM Schneidplatten

R	25	I	1.00	ISO	TM	VBX
1	2	3	4	5	6	7

1- Fertigungsprogramm	2- Schneidplattentype	3- Art der Schneidplatte	4- Teilung	5- Norm	6- System	7- Hartmetallsorte
R- MiTM Programm	24, 25, 40, 41	I - Innengewinde E - Außen EI - Außen+Innengewinde NC - Wuchtleiste	0.5-6.0 mm 32-4 tpi	ISO- ISO Metrisch UN- Amerikanisch UN W- BSW, BSP NPT- NPT NPTF- NPTF BSPT- BSPT	TM	VBX VTX

MiTM Trägerkörper (standard und konisch)

R	TM	C		25	17	-	26	S	2
1	2	3		4	5		6	7	8

1- Fertigungsprogramm	2- Trägerkörper type	3- Kühlung	4- Schaftdurchmesser [mm]	5- Schneidendurchmesser [mm]
R- MiTM Programm BR - MiTM mit AntiVibrationssystem	TM - Standardträgerkörper TMN - Konischer Trägerkörper	C- Kühlkanal	20, 25, 32	13.6 - 36

6- Nutzbare Einsatztiefe [mm]	7- Schneidplattentype	8- Anzahl der Schneiden
26 - 80	M - 24 S - 25 L - 40 B - 41	1 - 5

MiTM Fräskopf

R	TM	C		D36	16	-	25S	5
1	2	3		4	5		6	7

1- Fertigungsprogramm	2- Trägerkörper type	3- Kühlung	4- Schneidendurchmesser [mm]	5- Aufnahmebohrungsdurchmesser [mm]
R- MiTM Programm	TM - Standardträgerkörper TMN - Konischer Trägerkörper	C- Kühlkanal	36 - 58	16, 22, 27

6- Schneidplattentype	7- Anzahl der Schneiden
25S 40L 41B	5 - 8

ISO metrisch

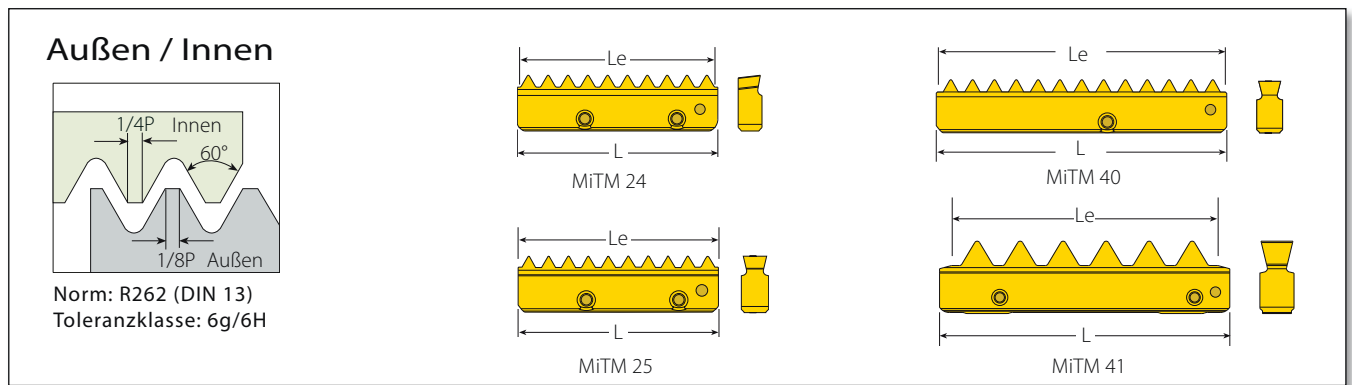

Standard MiTM

L mm	Teilung mm	Bestellnummer		Schneidkante	Zähne Zt	Trägerkörper
		Außen	Innen			
24	0.50		R24I0.50ISOTM...	1	24.50	RTMC...M
	0.75		R24I0.75ISOTM...	1	24.75	
	1.00		R24I1.00ISOTM...	1	24.00	
	1.25		R24I1.25ISOTM...	1	25.00	
	1.50		R24I1.50ISOTM...	1	24.00	
	1.75		R24I1.75ISOTM...	1	24.50	
	2.00		R24I2.00ISOTM...	1	24.00	
	2.50		R24I2.50ISOTM...	1	25.00	
25	1.00	R25E1.00ISOTM...	R25I1.00ISOTM...	2	24.00	(B)RTMC...S
	1.50	R25E1.50ISOTM...	R25I1.50ISOTM...	2	24.00	
	2.00	R25E2.00ISOTM...	R25I2.00ISOTM...	2	24.00	
	2.50	R25E2.50ISOTM...	R25I2.50ISOTM...	2	25.00	
	3.00	*R25E3.00ISOTM...	*R25I3.00ISOTM...	2	24.00	
40	1.00		R40I1.00ISOTM...	2	39.00	(B)RTMC...L
	1.50		R40I1.50ISOTM...	2	39.00	
	2.00		R40I2.00ISOTM...	2	38.00	
	2.50		R40I2.50ISOTM...	2	37.50	
	3.00		R40I3.00ISOTM...	2	39.00	
41	3.00	R41E3.00ISOTM...	R41I3.00ISOTM...	2	39.00	RTMC...B
	3.50	R41E3.50ISOTM...	R41I3.50ISOTM...	2	38.50	
	4.00	R41E4.00ISOTM...	R41I4.00ISOTM...	2	40.00	
	4.50	R41E4.50ISOTM...	R41I4.50ISOTM...	2	40.50	
	5.00	R41E5.00ISOTM...	R41I5.00ISOTM...	2	40.00	
	5.50	R41E5.50ISOTM...	R41I5.50ISOTM...	2	38.50	
	6.00	R41E6.00ISOTM...	R41I6.00ISOTM...	2	36.00	

* Anmerkung: 3.00 ISO Schneidplatten passen nicht in den Trägerkörper RTMC2517...
Für die CNC Programmierung bei Außengewindeplatten 3.0 ISO (D2 + 0.5mm)

MiTM Schneidplatten 25, 40 and 41 werden mit 2 Schneidkanten angeboten. Bei Spanfluss Problemen können auf Wunsch einschneidige Schneidplatten bestellt werden. Beispiel: R25I2.00ISOTM(S)...



Amerikanisch UN

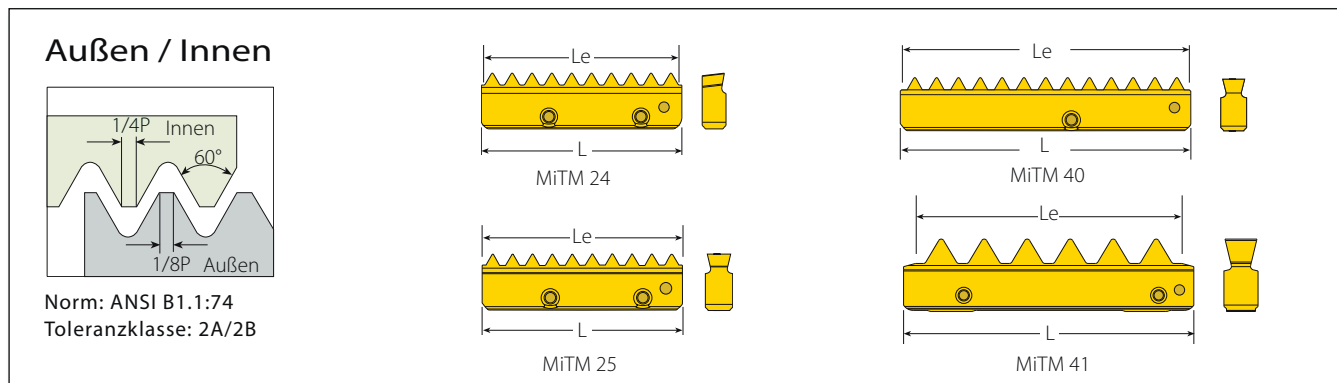

Standard MiTM

L	Teilung	Bestellnummer		Schneidkante	Zähne	Trägerkörper	
		Außen	Innen				
mm	tpi			Le	Zt		
24	32		R24I32UNTM...	1	24.61	31	
	28		R24I28UNTM...	1	24.49	27	
	24		R24I24UNTM...	1	24.34	23	
	20		R24I20UNTM...	1	24.13	19	
	18		R24I18UNTM...	1	23.99	17	RTMC...M
	16		R24I16UNTM...	1	23.81	15	
	14		R24I14UNTM...	1	23.59	13	
	12		R24I12UNTM...	1	23.28	11	
25	10		R24I10UNTM...	1	22.86	9	
	20	R25E20UNTM...	R25I20UNTM...	2	24.13	19	
	18	R25E18UNTM...	R25I18UNTM...	2	23.99	17	
	16	R25E16UNTM...	R25I16UNTM...	2	23.81	15	(B)RTMC...S
	14	R25E14UNTM...	R25I14UNTM...	2	23.58	13	
	12	R25E12UNTM...	R25I12UNTM...	2	23.28	11	
	10	R25E10UNTM...	R25I10UNTM...	2	22.86	9	
	9	*R25E9UNTM...	*R25I9UNTM...	2	22.58	8	* Siehe untenstehende Anmerkung
40	8	*R25E8UNTM...	*R25I8UNTM...	2	22.22	7	
	20		R40I20UNTM...	2	39.37	31	
	18		R40I18UNTM...	2	39.51	28	
	16		R40I16UNTM...	2	39.69	25	
	14		R40I14UNTM...	2	39.91	22	(B)RTMC...L
	12		R40I12UNTM...	2	38.10	18	
	10		R40I10UNTM...	2	38.10	15	
	9		R40I9UNTM...	2	39.51	14	
41	8		R40I8UNTM...	2	38.10	12	
	8	R41E8UNTM...	R41I8UNTM...	2	38.10	12	
	7	R41E7UNTM...	R41I7UNTM...	2	39.91	11	
	6	R41E6UNTM...	R41I6UNTM...	2	38.10	9	RTMC...B
	5	R41E5UNTM...	R41I5UNTM...	2	35.56	7	
	4.5	R41E4.5UNTM...	R41I4.5UNTM...	2	39.51	7	
	4	R41E4UNTM...	R41I4UNTM...	2	38.10	6	

* Anmerkung: 8 UN & 9 UN Schneidplatten passen nicht in den Trägerkörper RTMC2517...
Für die CNC Programmierung bei Außengewindeplatten 8 UN (D2 + 0.5mm)

MiTM Schneidplatten 25, 40 und 41 werden mit 2 Schneidkanten angeboten. Bei Spanfluss Problemen können auf Wunsch einschneidige Schneidplatten bestellt werden. Beispiel: R25I20UNTM(S)...



NPT

Außen / Innen

Norm: USAS B2.1:1968
Toleranzklasse: Standard NPT

Standard MiTM

L	Teilung	Bestellnummer	Schneidkante	Zähne		Trägerkörper
				Le	Zt	
24	18	R24EI18NPTTM...	1	23.99	17	RTMNC... M
	14	R25EI14NPTTM...	1	23.58	13	RTMNC... S
25	11.5	R25EI11.5NPTTM...	1	24.30	11	RTMNC-D36-16-25 S5
	8	R25EI8NPTTM...	1	22.22	7	
40	11.5	R40EI11.5NPTTM...	1	37.55	17	RTMNC-D45-22-40 L6
	8	R40EI8NPTTM...	1	38.10	12	
41	8	R41EI8NPTTM...	1	38.10	12	RTMC... B

NPTF

Außen / Innen

Norm: ANSI B1.20.3-1976
Toleranzklasse: Standard NPTF

Standard MiTM

L	Teilung	Bestellnummer	Schneidkante	Zähne		Trägerkörper
				Le	Zt	
24	18	R24EI18NPTFTM...	1	23.99	17	RTMNC... M
	14	R25EI14NPTFTM...	1	23.58	13	RTMNC... S
25	11.5	R25EI11.5NPTFTM...	1	24.30	11	RTMNC-D36-16-25 S5
	8	R25EI8NPTFTM...	1	22.22	7	
40	11.5	R40EI11.5NPTFTM...	1	37.55	17	RTMNC-D45-22-40 L6
	8	R40EI8NPTFTM...	1	38.10	12	
41	8	R41EI8NPTFTM...	1	38.10	12	RTMC... B

Whitworth für BSF, BSP (G)

Außen / Innen

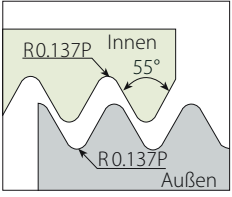

Norm: B.S.84:1956, DIN 259, ISO228/1:1982
Toleranzklasse: Medium Class A

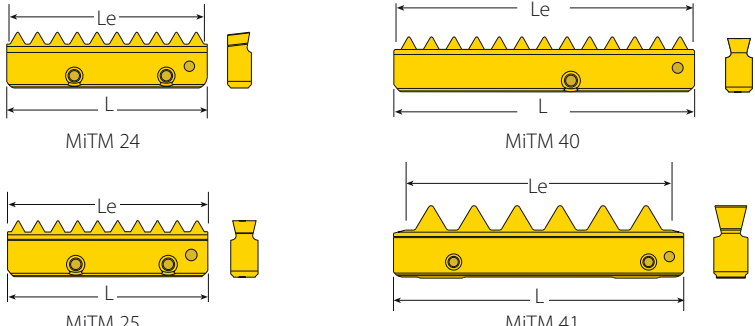

Standard MiTM

L mm	Teilung tpi	Bestellnummer		Schneidkante	Zähne Le	Trägerkörper Zt
		Außen + Innen	Innen			
24	19	R24EI19WTM...		1	24.06	18
	14	R24EI14WTM...		1	23.59	13
	12	R24EI12WTM...		1	23.28	11
25	16	R25EI16WTM...		2	23.81	15
	14	R25EI14WTM...		2	23.58	13
	12	R25EI12WTM...		2	23.28	11
	11	R25EI11WTM...		2	23.09	10
40	16	R40EI16WTM...		2	39.69	25
	14	R40EI14WTM...		2	39.91	22
	12	R40EI12WTM...		2	38.10	18
	11	R40EI11WTM...		2	39.25	17
41	8		R41I8WTM...	2	38.10	12
	7		R41I7WTM...	2	39.91	11
	6		R41I6WTM...	2	38.10	9

MITM

MiTM Schneidplatten 25, 40 und 41 werden mit 2 Schneidkanten angeboten. Bei Spanfluss Problemen können auf Wunsch einschneidige Schneidplatten bestellt werden. Beispiel: R25EI16WTM(S)...



BSPT

Außen / Innen

Norm: B.S. 21:1985
Toleranzklasse: DIN EN 10226-1

Standard MiTM

L mm	Teilung tpi	Bestellnummer Außen + Innen	Schneidkante	Zähne Zt	Trägerkörper
24	19	R24EI19BSPTTM...	1	24.06	18
	14	R25EI14BSPTTM...			
25	11	R25EI11BSPTTM...	1	23.09	10
		R40EI11BSPTTM...			
40	11	R40EI11BSPTTM...	1	39.25	17

Wuchtplatte*

L mm	Bestellnummer Außen + Innen	Zähne Zt	Trägerkörper
24	R24NC	keine Zähne	RTMC...M
25	R25NC		(B)RTMC...S
			RTMNC...S
40	R40NC		(B)RTMC...L
41	R41NC	RTMC...B	

alle Typen

*Unbenutzte Plattensitze müssen mit Wuchtleisten (R...NC) belegt werden. Dies gewährleistet eine Stabilität des Fräsprozesses und vermeidet die Ablagerung von Spänen in den ungenutzten Plattensitzen.

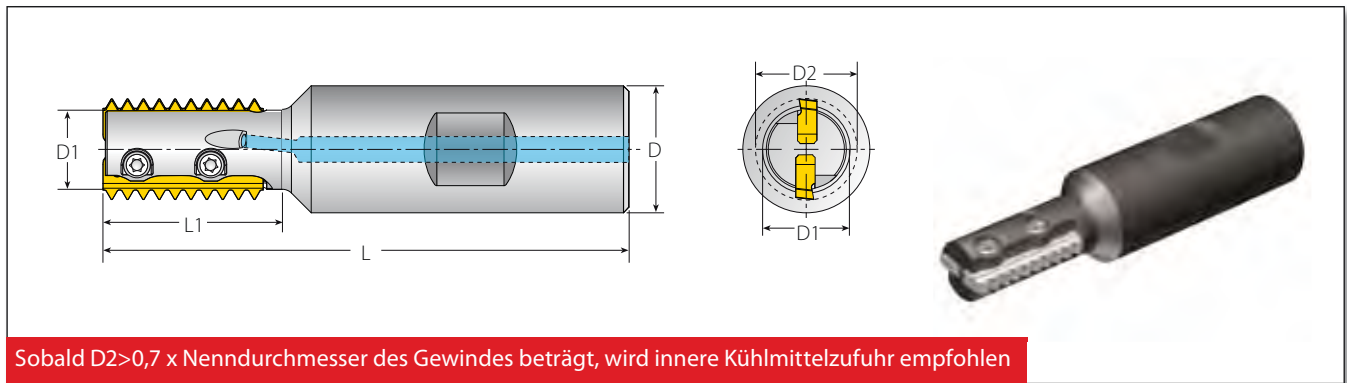

MITM

Standardträgerkörper (MiTM 24)



Sobald $D2 > 0,7 \times$ Nenndurchmesser des Gewindes beträgt, wird innere Kühlmittelzufuhr empfohlen

RTMC - für Standardgewinde

RTMC - für Standardgewinde								Ersatzteile	
Schneidplattentype	Bestellnummer	Maße (mm)			Zähnezahl				
mm		L	L1	D	D1	D2	Z	Arretierungsschraube x2	Torx+ Schraubendreher
24	RTMC 2013-26M1	82	26	20	10.7	13.6	1	SLD4IP8 (M4x0.7)	KIP8 •Nur den beigelegten Vardex Torx + Schraubendreher benutzen •Empfohlenes max. Drehmoment 1,2 Nm
	RTMC 2015-30M1	85	30	20	11.9	15.1	1		
	RTMC 2016-28M2	83	28	20	12.6	16	2		
	RTMC 2016-36M1	91	36	20	12.6	16	1		

Normgewindeanwendung pro Trägerkörper

Trägerkörper	Anwendungsbereich Ø						
	D2 (mm)	ISO (coarse)	ISO (fine)	UNC	UN/UNF/UNEF/UNS	BSF	BSP(G)
RTMC 2013-26M1	13.6	M16x2	M14.5x0.5; M15X0.75; M15x1; M15x1.25; M16x1.5; M16x1.75	-	1/16-12UN; 3/16-14UNS; 3/16-16UN; 3/16-18UNF; 3/16-20UN; 3/16-24UNEF; 3/16-28UN; 3/16-32UN	1/16-14; 3/4-12	3/8-19
RTMC 2015-30M1	15.1	M18x2.5	M16x0.5; M17X0.75; M17x1; M17x1.25; M17x1.5; M18x1.75; M18x2	3/4-10	3/4-12UN; 3/4-14UNS; 1/16-16UN; 1/16-20UN; 1/16-24UNEF; 1/16-28UN; 1/16-32UN	3/4-12	-
RTMC 2016-28M2	16	M20x2.5	M17x0.5; M17x0.75; M18x1; M18x1.25; M18x1.5; M18x1.75; M19x2	3/4-10	3/4-12UN; 3/4-14UNS; 3/4-16UN; 3/4-18UNS; 3/4-20UNEF; 1/16-24UNEF; 1/16-28UN; 1/16-32UN	3/4-12	-
RTMC 2016-36M1	16	M20x2.5	M17x0.5; M17x0.75; M18x1; M18x1.25; M18x1.5; M18x1.75; M19x2	3/4-10	3/4-12UN; 3/4-14UNS; 3/4-16UN; 3/4-18UNS; 3/4-20UNEF; 1/16-24UNEF; 1/16-28UN; 1/16-32UN	3/4-12	-



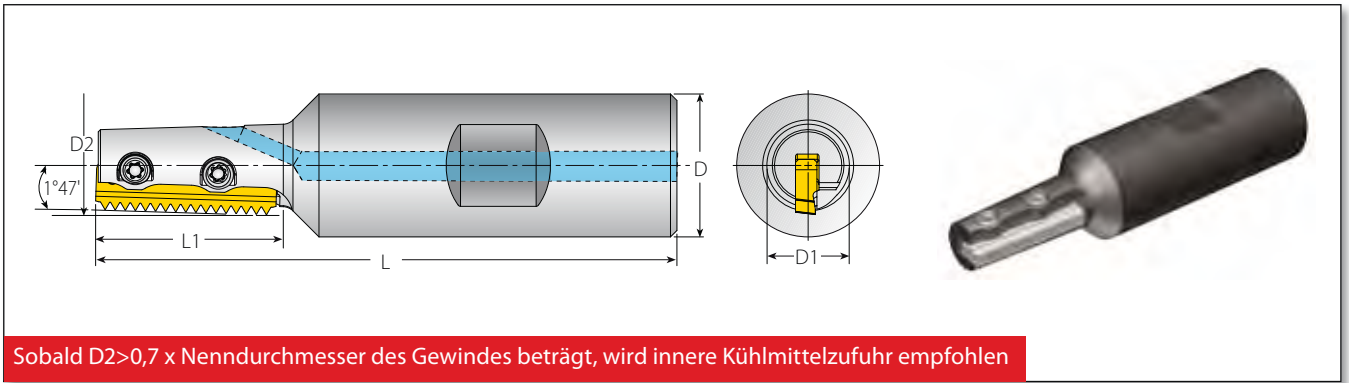

Konische Trägerkörper (MiTM 24)



Sobald $D2 > 0,7 \times$ Nenndurchmesser des Gewindes beträgt, wird innere Kühlmittelzufuhr empfohlen

RTMC - für Standardgewinde

RTMC - für Standardgewinde								Ersatzteile	
Schneidplattentype	Bestellnummer	Maße (mm)			Zähnezahl				
mm		L	L1	D	D1	D2	Z	Arretierungsschraube x2	Torx+ Schraubendreher
24	RTMNC 2014-26M1	81	26	20	11.5	13.9	1	SLD4IP8 (M4x0.7)	KIP8 <ul style="list-style-type: none"> Nur den beigelegten Vardex Torx + Schraubendreher benutzen Empfohlenes max. Drehmoment 1,2 Nm

Normgewindeanwendung pro Trägerkörper

Trägerkörper				
	D2 (mm)	NPT	NPTF	BSPT
RTMNC 2014-26M1	13.9	3/8-18	3/8-18	3/8-19

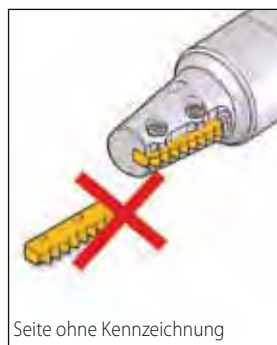

Standardträgerkörper (MiTM 25)

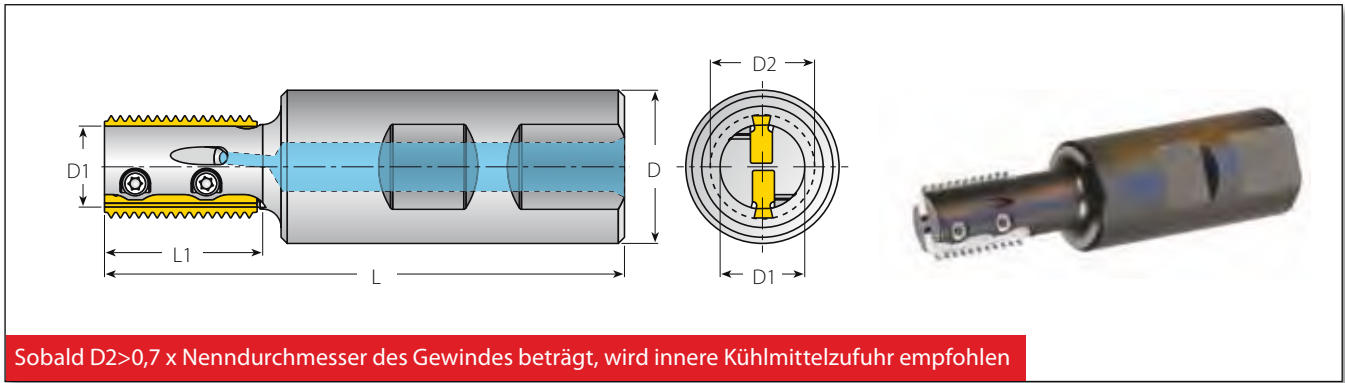

Sobald $D2 > 0,7 \times$ Nenndurchmesser des Gewindes beträgt, wird innere Kühlmittelzufuhr empfohlen

RTMC - für Standardgewinde

RTMC - für Standardgewinde								Ersatzteile	
Schneidplattentyp	Bestellnummer	Maße (mm)			Zähnezahl				
mm		L	L1	D	D1	D2	Z	Arretierungsschraube x2	Torx+ Schraubendreher
25	RTMC 2517-26S2	85	26	25	14	17	2	SLD4IP8 (M4x0.7)	KIP8 •Nur den beigelegten Vardex Torx + Schraubendreher benutzen •Empfohlenes max. Drehmoment 1,2 Nm
	RTMC 2517-36S2	95	36		14	17	2		
	RTMC 2519-32S2	92	32		15	19	2		
	RTMC 2519-44S2	104	44		15	19	2		
	RTMC 2520-37S3	96	37		16.5	20.5	3		
	RTMC 2520-44S3	103	44		16.5	20.5	3		
	RTMC 2522-43S3	102	43		18	22	3		
	RTMC 2522-55S3	114	55		18	22	3		
	RTMC 2530-55S5	115	55		26	30	5		
BRTMC 2530-80S4	140	80	26	30	4				

Normgewindeanwendung pro Trägerkörper

Trägerkörper	Anwendungsbereich Ø							
D2 (mm)	ISO (coarse)	ISO (fine)	UNC	UN/UNF/UNEF/UNS		BSF	BSP(G)	
RTMC 2517-26S2	17	M20x2.5	M19x1; M19x1.5; M20x2	-	7/8-10UNS; 13/16-12UN; 7/8-14UNF; 3/4-16UNF; 3/4-18UNS; 3/4-20UNEF		7/8-11; 7/8-12; 7/8-14; 7/8-16	1/2-14
RTMC 2517-36S2								
RTMC 2519-32S2	19	M22x2.5 M24x3	M21x1; M21x1.5; M22x2	7/8-9; 1-8	7/8-20UNEF; 7/8-18UNS; 7/8-16UN; 7/8-14UNF; 7/8-12UN; 7/8-10UNS		7/8-16; 7/8-14; 15/16-12; 15/16-11	5/8-14
RTMC 2519-44S2								
RTMC 2520-37S3	20.5	M24x3	M22x1; M23x1.5; M23x2; M23.5x2.5	1-8	15/16-9UN; 1-10UNS; 15/16-12UN; 1-14UNS; 15/16-16UN; 7/8-18UNS; 7/8-20UNEF		1-11; 1-12; 1-14; 1-16	5/8-14
RTMC 2520-44S3								
RTMC 2522-43S3	22	M27x3	M24x1; M24x1.5; M25x2; M25x2.5	-	1 1/16-8UN; 1-9UN; 1-10UNS; 1-12UNF; 1-14UNS; 1-16UN; 1-18UN; 15/16-20UNEF		1-11; 1-12; 1-14; 1-16	3/4-14
RTMC 2522-55S3								
RTMC 2530-55S5	30	-	M32x1; M32x1.5; M33x2; M33x2.5; M34x3	-	1 3/8-8UN; 1 3/8-9UN; 1 3/8-10UN; 1 3/8-12UN; 1 3/8-14UNS; 1 1/2-16UN; 1 1/2-18UNEF; 1 1/2-20UN		1 3/8-11; 1 3/8-12; 1 3/8-14; 1 3/8-16	1-11
BRTMC 2530-80S4								

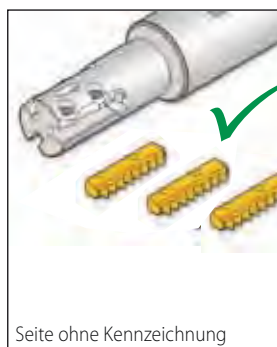
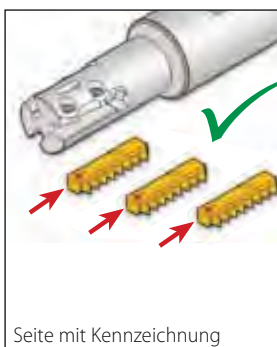

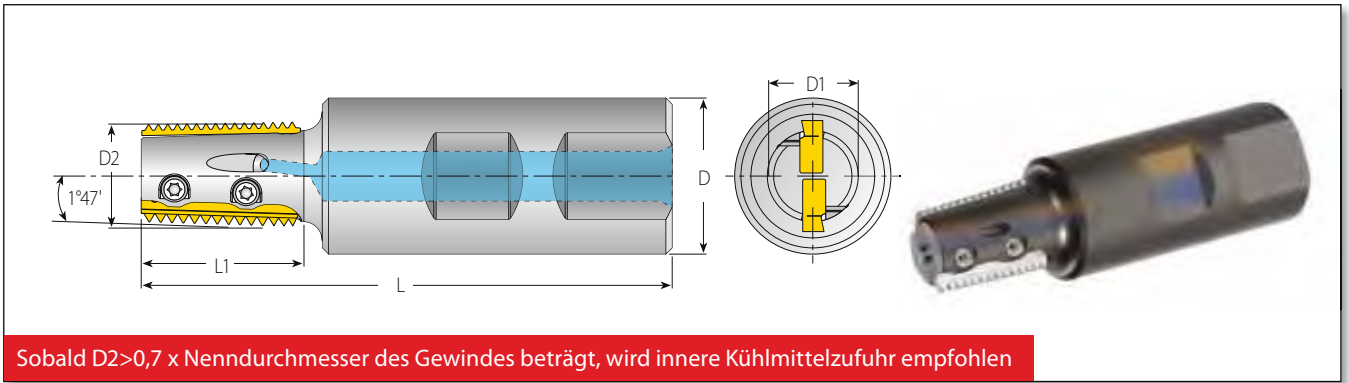

Konische Trägerkörper (MiTM 25)



Sobald $D2 > 0,7 \times$ Nenndurchmesser des Gewindes beträgt, wird innere Kühlmittelzufuhr empfohlen

Trägerkörper - für konische Gewinde

Trägerkörper - für konische Gewinde								Ersatzteile	
Schneidplattentype	Bestellnummer	Maße (mm)			Zähnezahl				
mm		L	L1	D	D1	D2	Z	Arretierungsschraube x2	Torx+ Schraubendreher
25	RTMNC 2517-26S2	85	26	25	14	17	2	SLD4IP8 (M4x0.7)	KIP8 •Nur den beigelegten Vardex Torx + Schraubendreher benutzen •Empfohlenes max. Drehmoment 1,2 Nm
	RTMNC 2522-43S3	102	43	25	18	22	3		
	RTMNC 2528-43S4	103	43	25	26	28	4		

Konische Gewindeanwendung pro Trägerkörper

Trägerkörper		Anwendungsbereich Ø		
	D2 (mm)	NPT	NPTF	BSPT
RTMNC 2517-26S2	17	½-14; ¾-14; 1-11.5; 1¼-11.5; 1½-11.5; 2-11.5	½-14; ¾-14; 1-11.5; 1¼-11.5; 1½-11.5; 2-11.5	½-14; ¾-14
RTMNC 2522-43S3	22	¾-14; 1-11.5; 1¼-11.5; 1½-11.5; 2-11.5	¾-14; 1-11.5; 1¼-11.5; 1½-11.5; 2-11.5	¾-14; 1-11; 1¼-11; 1½-11; 2-11; 2½-11; 3-11; 4-11; 5-11; 6-11
RTMNC 2528-43S4	28	1-11.5; 1¼-11.5; 1½-11.5; 2-11.5	1-11.5; 1¼-11.5; 1½-11.5; 2-11.5	1-11; 1¼-11; 1½-11; 2-11; 2½-11; 3-11; 4-11; 5-11; 6-11

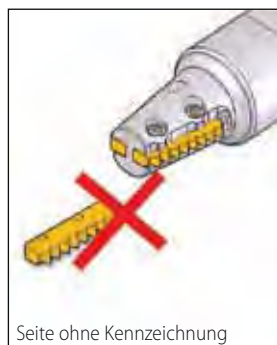

Fräskopf (MiTM 25)

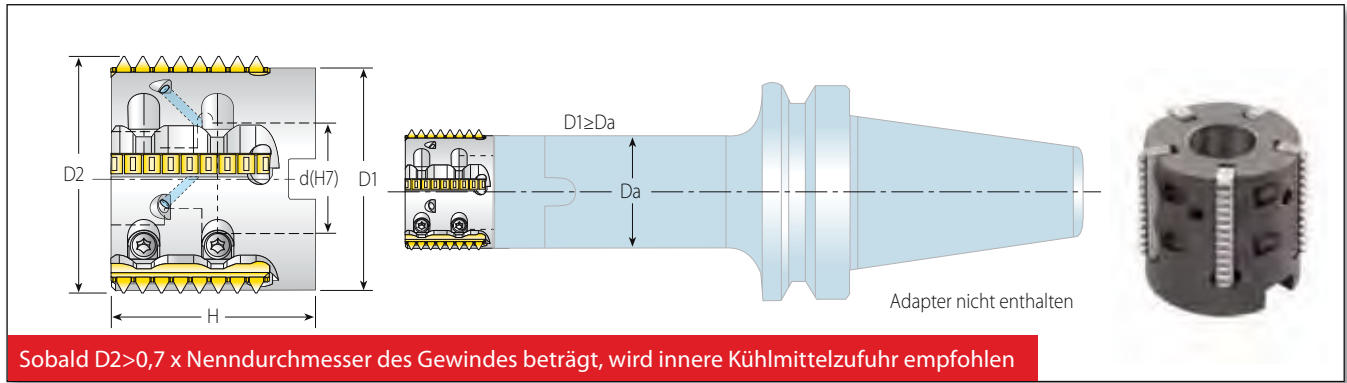

Konische und Standardfräsköpfe

Ersatzteile

Schneidplattentyp		Bestellnummer	Maße (mm)				Zähnezahl	Ersatzteile			
mm			D1	D2	d(H7)	H	Z				
Standard	25	RTMC D36-16-25S5	32	36	16	33.5	5	SLD4IP8 (M4x0.7)	Torx + Schraubendreher	KIP8 • Nur den beigelegten Vardex Torx + Schraubendreher benutzen • Empfohlenes max. Drehmoment 1,2 Nm	M8x1.25x30
		RTMC D44-22-25S6	40	44	22	38	6				M10x1.50x35
		RTMC D52-27-25S8	48	52	27	40	8				M12x1.75x30
Konisch	RTMNC D36-16-25S5	32	36*	16	33.5	5	M8x1.25x30				

* Für die CNC Programmierung bei 8NPT und 8NPTF Schneidplatten - D2 + 0,6mm

Normgewindeanwendung pro Trägerkörper

Trägerkörper		Anwendungsbereich Ø				
		D2 (mm)	ISO (fine)	UN/UNF/UNEF/UNS	BSW	BSP(G)
Standard	RTMC D36-16-25S5	36	M38x1; M39x1.5; M39x2; M40x3	1 1/16-12UN; 1 1/8-14UNS; 1 1/16-16UN; 1 1/2-18UNEF; 1 1/2-20UN	1 3/4-16 1 3/4-12	1 1/4-11
	RTMC D44-22-25S6	44	M48x1; M48x1.5; M48x2; M48x3	1 7/8-12UN; 1 13/16-16UN; 1 13/16-20UN; 1 5/8-8UN; 1 7/8-10UNS; 1 7/8-14UNS	2-16 2-12	1 1/2-11
	RTMC D52-27-25S8	52	M55x1; M55x1.5; M55x2; M56x3	2 1/4-8UN; 2 1/4-10UN; 2 1/4-12UN; 2 1/4-14UN; 2 1/4-16UN; 2 1/4-18UN; 2 1/4-20UN	2 1/4-16 2 1/4-12	2-11

Konische Gewindeanwendung pro Trägerkörper

Trägerkörper		Anwendungsbereich Ø			
		D2 (mm)	NPT	NPTF	BSPT
Konisch	RTMNC D36-16-25S5	36	1 1/4-11.5; 1 1/2-11.5; 2-11.5 2 1/2-8 (and up)	1 1/4-11.5; 1 1/2-11.5; 2-11.5 2 1/2-8; 3-8	1 1/2-6x11

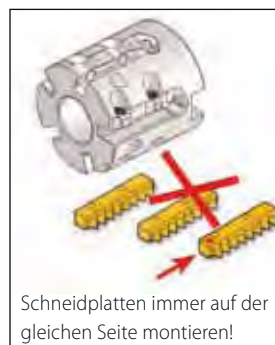
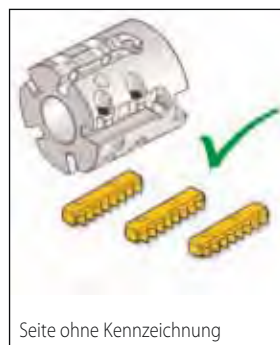
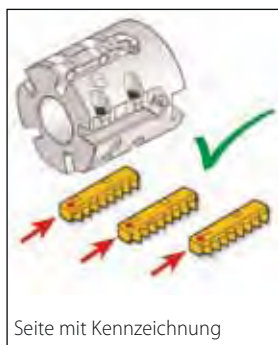

Standardträgerkörper (MiTM 40)

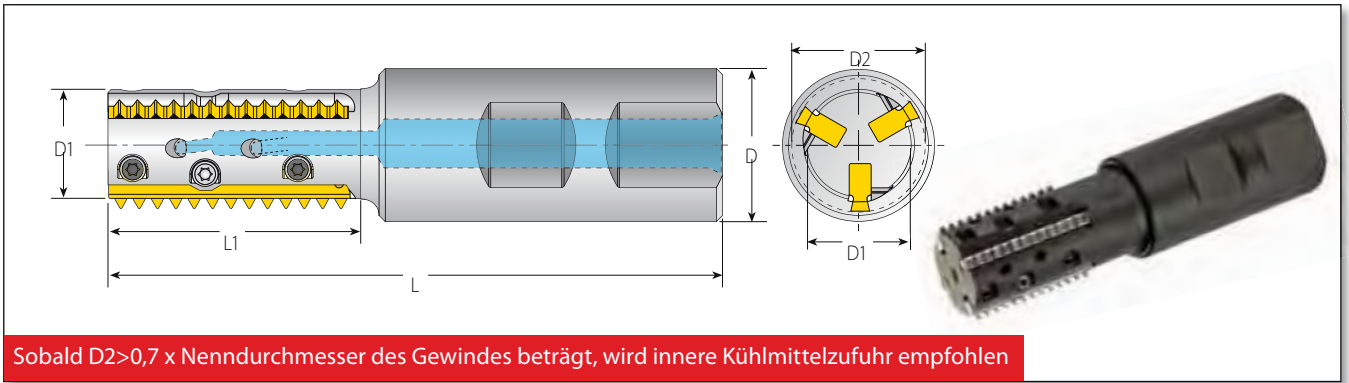

Sobald $D2 > 0,7 \times$ Nenndurchmesser des Gewindes beträgt, wird innere Kühlmittelzufuhr empfohlen

Trägerkörper - für Standardgewinde

Schneidplattentype	Bestellnummer	Maße (mm)						Zähnezahl	Ersatzteile		
		L	L1	D	D1	D2	Z				
mm		L	L1	D	D1	D2	Z	Justierschraube	Klemmschraube x2	Torx+ Schraubendreher	
40	RTMC 2522-43L3	102	43	25	18	22	3	SLD4IP8A (M4x0.7)	SCD4IP8 (M4x0.7)	KIP8 •Nur den beigelegten Vardex Torx + Schraubendreher benutzen •Empfohlenes max. Drehmoment 1,2 NxM	
	RTMC 2522-65L3	124	65	25	18	22	3				
	RTMC 3230-55L4	117	55	32	26	30	4				
	BRTMC 3230-80L3	142	80	32	26	30	3				

Normgewindeanwendung pro Trägerkörper

Trägerkörper	Anwendungsbereich Ø						
	D2 (mm)	ISO (coarse)	ISO (fine)	UNC	UN/UNF/UNEF/UNS	BSF	BSP(G)
RTMC 2522-43L3	22	M27x3	M24x1; M24x1.5 M25x2; M25x2.5	-	1 1/16-8UN; 1-9UN; 1-10UNS; 1-12UNF; 1-14UNS; 1-16UN; 1-18UN; 1 1/16-20UNEF	1-11; 1-12; 1-14; 1-16;	3/4-14
RTMC 2522-65L3	22	M27x3	M24x1; M24x1.5 M25x2; M25x2.5	-	1 1/16-8UN; 1-9UN; 1-10UNS; 1-12UNF 1-14UNS; 1-16UN; 1-18UN; 1 1/16-20UNEF	1-11; 1-12; 1-14; 1-16;	3/4-14
RTMC 3230-55L4	30	-	M32x1; M32x1.5 M33x2; M33x2.5; M34x3	-	1 3/8-8UN; 1 3/8-9UN; 1 3/8-10UN; 1 1/16-12UN; 1 3/8-14UNS; 1 1/16-16UN; 1 1/16-18UNEF; 1 1/16-20UN	1 3/8-11; 1 3/8-12; 1 3/8-14; 1 3/8-16	1-11
BRTMC 3230-80L3	30	-	M32x1; M32x1.5 M33x2; M33x2.5; M34x3	-	1 3/8-8UN; 1 3/8-9UN; 1 3/8-10UN; 1 1/16-12UN; 1 3/8-14UNS; 1 1/16-16UN; 1 1/16-18UNEF; 1 1/16-20UN	1 3/8-11; 1 3/8-12; 1 3/8-14; 1 3/8-16	1-11



2- Stufen Spannsystem!

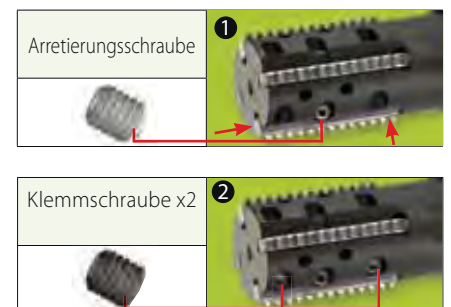

Fräskopf (MiTM 40)

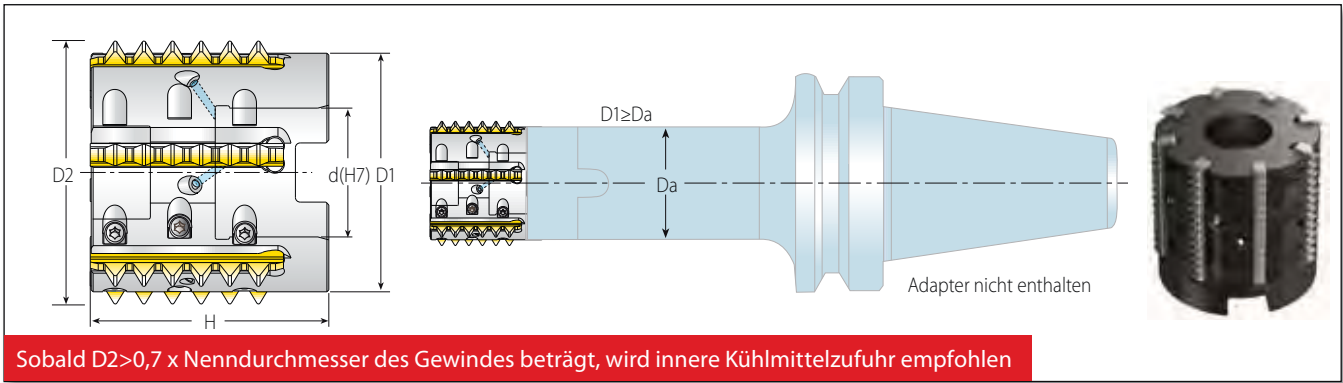

Sobald $D2 > 0,7 \times$ Nenndurchmesser des Gewindes beträgt, wird innere Kühlmittelzufuhr empfohlen

Konische und Standardfräsköpfe

Ersatzteile

Schneidplattentyp	Bestellnummer	Maße (mm)				Zähnezahl	Ersatzteile				
		D1	D2	d(H7)	H		Z	Arretierungsschraube	Klemmschraube x2	Torx + Schraubendreher	Halteschraube
Standard	RTMC D44-22-40L6	40	44	22	48	6	SLD4IP8A (M4x0.7)	SCD4IP8 (M4x0.7)	Torx + Schraubendreher	KIP8 • Nur den beigelegten Vardex Torx + Schraubendreher benutzen • Empfohlenes max. Drehmoment 1,2 Nm	M10x1.5x40
	RTMC D52-27-40L8	48	52	27	50	8					M12x1.75x40
Konisch	RTMNC D45-22-40L6	40	45	22	48	6					M10x1.5x40

Normgewindeanwendung pro Trägerkörper

Trägerkörper		Anwendungsbereich Ø				
D2 (mm)		ISO (fine)	UN/UNF/UNEF/UNS	BSW	BSP(G)	
Standard	RTMC D44-22-40L6	M48x1; M48x1.5; M48x2; M48x3	1 7/8-12UN; 1 13/16-16UN; 1 13/16-20UN; 1 15/16-8UN; 1 7/8-10UNS; 1 7/8-14UNS	2-16 2-12	1 1/2-11	
	RTMC D52-27-40L8	M55x1; M55x1.5; M55x2; M56x3	2 1/4-8UN; 2 1/4-10UN; 2 1/4-12UN; 2 1/4-14UN; 2 1/4-16UN; 2 1/4-18UN; 2 1/4-20UN	2 1/4-16 2 1/4-12	2-11	

Konische Gewindeanwendung pro Trägerkörper

Trägerkörper		Anwendungsbereich Ø			
D2 (mm)		NPT	NPTF	BSPT	
Konisch	RTMNC D45-22-40L6	2-11.5; 2 1/2-8 (and up)	2-11.5; 2 1/2-8; 3-8	2-6x11	

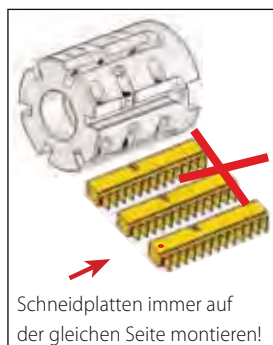
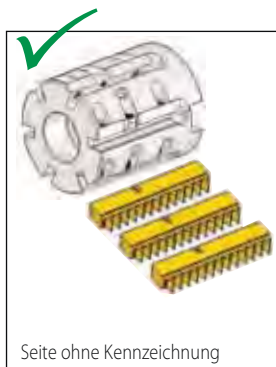
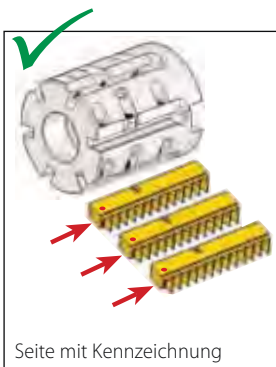

2- Stufen Spannsystem!

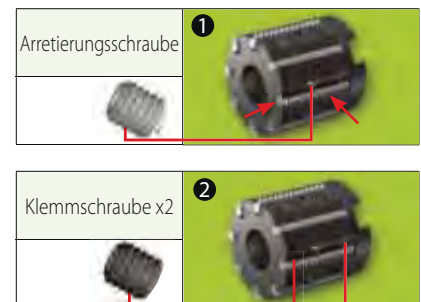

Standardträgerkörper (MiTM 41)

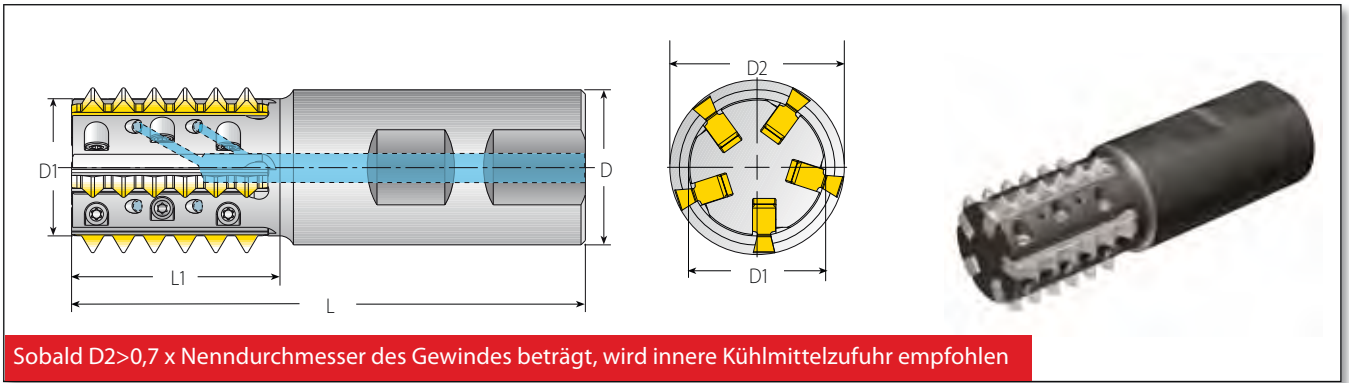

Sobald $D2 > 0,7 \times$ Nenndurchmesser des Gewindes beträgt, wird innere Kühlmittelzufuhr empfohlen

Trägerkörper - für Standardgewinde

Trägerkörper - für Standardgewinde								Ersatzteile		
Schneidplattentyp	Bestellnummer	Maße (mm)			Zähnezahl					
mm		L	L1	D	D1	D2*	Z	Arretierungsschraube x2	Klemmschraube	Torx+ Schraubendreher
41	RTMC 2524-43B2	104	43	25	19.2	24.5	2	SLD4IP8A (M4x0.7)	SCD4IP8 (M4x0.7)	KIP8 • Nur den beigelegten Vardex Torx + Schraubendreher benutzen • Empfohlenes max. Drehmoment 1,2 Nm
	RTMC 3230-43B3	106.5	43	32	24.2	30	3			
	RTMC 3230-65B3	128.5	65	32	24.2	30	3			
	RTMC 3236-43B5	106	43	32	28.3	36	5			
	RTMC 3236-65B4	128	65	32	28.3	36	4			

Normgewindeanwendung pro Trägerkörper

Trägerkörper	Anwendungsbereich \emptyset							
	D2* (mm)	ISO (coarse)	ISO (fine)	UNC	UN/UNF/UNEF/UNS	BSW/BSF	NPT	NPTF
RTMC 2524-43B2	24.5	M30x3.5; M36x4	M28X3; M45x4	1 $\frac{1}{8}$ -7; 1 $\frac{1}{8}$ -6	1 $\frac{1}{8}$ -8UN; 1 $\frac{1}{16}$ -6UN	1 $\frac{3}{8}$ -8BSF; 1 $\frac{1}{4}$ -7BSW	-	-
RTMC 3230-43B3	30	M36x4; M42x4.5	M34X3; M34x3.5; M45x4	1 $\frac{3}{8}$ -6	1 $\frac{3}{8}$ -8UN; 1 $\frac{1}{16}$ -6UN	1 $\frac{3}{8}$ -8BSF; 1 $\frac{3}{4}$ -7BSF; 1 $\frac{1}{2}$ -6BSW	-	-
RTMC 3230-65B3	30	M36x4; M42x4.5	M34X3; M34x3.5; M45x4	1 $\frac{3}{8}$ -6	1 $\frac{3}{8}$ -8UN; 1 $\frac{1}{16}$ -6UN	1 $\frac{3}{8}$ -8BSF; 1 $\frac{3}{4}$ -7BSF; 1 $\frac{1}{2}$ -6BSW	-	-
RTMC 3236-43B5	36	M42x4.5; M48x5; M56x5.5; M64x6	M40x3; M40x3.5; M42x4; M70x6	1 $\frac{3}{4}$ -5; 2-4.5; 2 $\frac{1}{2}$ -4	1 $\frac{3}{8}$ -8UN; 1 $\frac{1}{8}$ -6UN	1 $\frac{5}{8}$ -8BSF; 1 $\frac{3}{4}$ -7BSF; 1 $\frac{1}{8}$ -6BSF	2 $\frac{1}{2}$ -8	2 $\frac{1}{2}$ -8
RTMC 3236-65B4	36	M42x4.5; M48x5; M56x5.5; M64x6	M40x3; M40x3.5; M42x4; M70x6	1 $\frac{3}{4}$ -5; 2-4.5; 2 $\frac{1}{2}$ -4	1 $\frac{3}{8}$ -8UN; 1 $\frac{1}{8}$ -6UN	1 $\frac{5}{8}$ -8BSF; 1 $\frac{3}{4}$ -7BSF; 1 $\frac{1}{8}$ -6BSF	2 $\frac{1}{2}$ -8	2 $\frac{1}{2}$ -8

* Für Außenanwendungen, Gewindeplatten R41E... für die CNC Programmierung (D2 + 0,6mm)



2- Stufen Spannsystem!

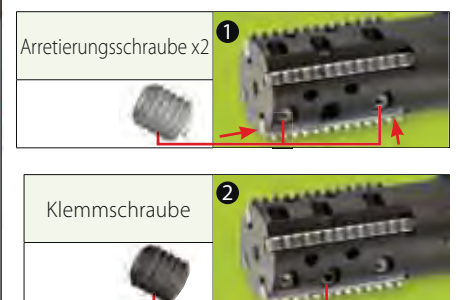

Fräskopf (MiTM 41)

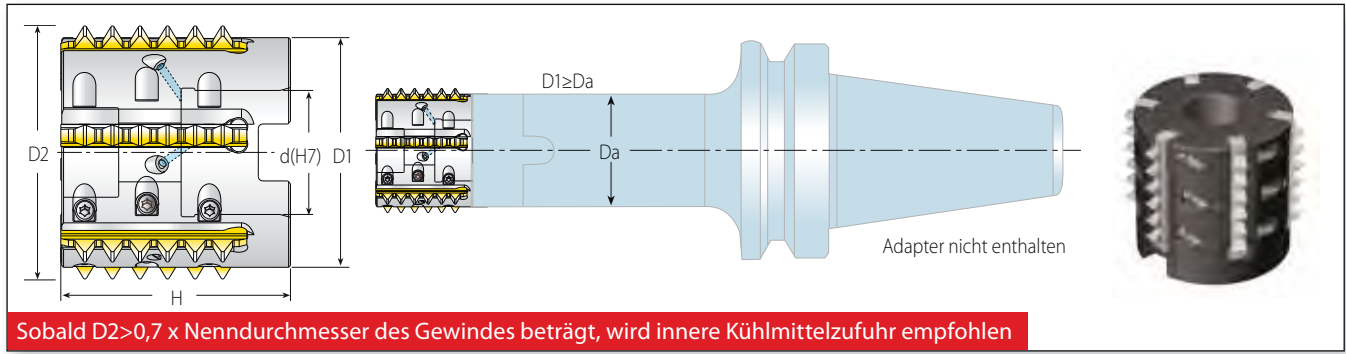

Standardfräsköpfe

Ersatzteile

Schneidplattentyp	Bestellnummer	Maße (mm)					Zähnezahl	Ersatzteile			
mm		D1	D2*	d(H7)	H	Z	Arretierungsschraube x2	Klemmschraube	Torx+ Schraubendreher	Halter	
41	RTMC D48-22-41B5	40	48	22	50	5	SLD4IP8A (M4x0.7)	SCD4IP8 (M4x0.7)	KIP8 •Nur den beigelegten Vardex Torx + Schraubendreher benutzen •Empfohlenes max. Drehmoment 1,2 Nm	M10x1.5x40	
	RTMC D58-27-41B6	50	58	27	50	6				M12x1.75x40	

Normgewindeanwendung pro Trägerkörper

Trägerkörper	Anwendungsbereich Ø							
	D2* (mm)	ISO (coarse)	ISO (fine)	UNC	UN/UNF/UNEF/UNS	BSF	NPT	NPTF
RTMC D48-22-41B5	48	M56x5.5; M64x6	M55x4; M70x6;	2 1/4-4.5; 2 1/2-4	2 1/8-8UN; 2 1/8-6UN	2 1/4-8; 2 1/4-6	2 1/2-8	2 1/2-8
RTMC D58-27-41B6	58	M68x6	M64x4; M70x6	2 3/4-4	2 1/2-8UN; 2 1/2-6UN	2 1/2-8; 2 3/4-6	2 1/2-8	2 1/2-8

* Für Außenanwendungen, Gewindeplatten R41E... für die CNC Programmierung (D2 + 0,6mm)

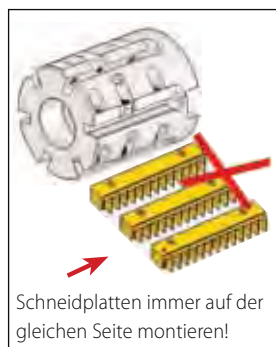
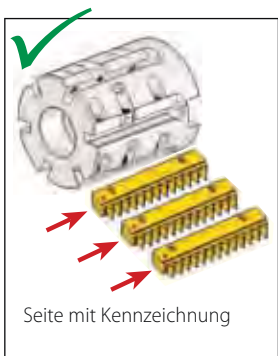

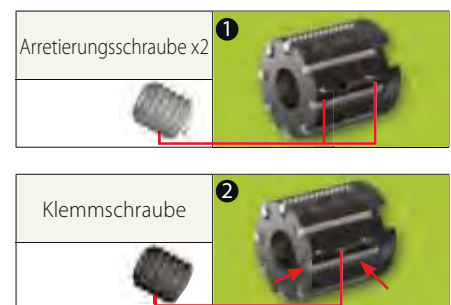

2- Stufen Spannsystem!



Empfohlene Sorten und Schnittgeschwindigkeiten Vc [m/ min] und Vorschübe fz [mm/ Zahn]

Materialgruppe	Vardex Nr.	Material	Brinell Härte HB	Vc [m/min]		Vorschub fz[mm/Zahn]	
				VBX	VTX	fz	
P Stahl	1	Unlegierter Stahl	Geringer Kohlenstoffanteil (C=0.1-0.25%)	125	100-210	90-180	0.1-0.35
	2		Mittlerer Kohlenstoffanteil (C=0.25- 0.55%)	150	100-180	90-170	0.1-0.4
	3		Hoher Kohlenstoffanteil (C= 0.55- 0.85%)	170	100-170	90-160	0.1-0.35
	4	Niedriglegierter Stahl (Legierungs- Elemente ≤ 5%)	Ungehärtet	180	90-60	90-155	0.1-0.4
	5		Gehärtet	275	80-150	80-160	0.1-0.35
	6		Gehärtet	350	70-140	70-150	0.1-0.3
	7	Hochlegierter Stahl (Legierungs- Elemente > 5%)	Vergütet	200	60-130	70-115	0.1-0.35
	8		Gehärtet	325	70-110	60-100	0.1-0.2
	9	Stahlguss	Niedriglegiert (Legierungs- Elemente ≤ 5%)	200	100-170	100-170	0.1-0.3
	10		Hochlegiert (Legierungs- Elemente > 5%)	225	70-120	70-130	0.1-0.2
M Edelstahl	11	Edelstahl Ferritisch	Ungehärtet	200	100-170	120-180	0.1-0.3
	12		Gehärtet	330	100-170	120-180	0.1-0.2
	13	Edelstahl Austenitisch	Austenitisch	180	70-140	100-140	0.1-0.3
	14		Super- Austenitisch	200	70-140	100-140	0.1-0.2
	15	Edelstahlguß Ferritisch	Ungehärtet	200	70-140	100-140	0.1-0.3
	16		Gehärtet	330	70-140	100-140	0.1-0.2
	17	Edelstahl Guss austenitisch	Austenitisch	200	70-120	100-120	0.1-0.3
	18		Gehärtet	330	70-120	100-120	0.1-0.2
K Gußeisen	28	Temperguss	Ferritisch (kurzspanig)	130	60-130	100-120	0.05-0.16
	29		Perlitisch (langspanig)	230	60-120	80-100	0.04-0.10
	30	Grauguss	Niedrigfest	180	60-130	80-100	0.1-0.3
	31		Hochfest	260	60-100	80-100	0.1-0.2
	32	Kugelgraphitguss	Ferritisch	160	60-125	80-100	0.1-0.3
33	Perlitisch		260	50-90	60-90	0.1-0.2	
N_(K) Nichteisen- Metalle	34	Aluminium- Legierungen schmiedeeisern	ungealtert	60	100-250		0.15-0.55
	35		gealtert	100	100-180		0.15-0.5
	36	Aluminium- Legierungen	Guß	75	150-400		0.15-0.5
	37		Guß & gealtert	90	150-280		0.1-0.4
	38	Aluminium- Legierungen	Guß Si 13- 22%	130	80-150		0.15-0.5
	39	Kupfer und Kupferlegierungen	Messing	90	120-210	100-200	0.15-0.5
40	Bronze und bleifreies Kupfer		100	120-210	100-200	0.1-0.4	
S_(M) Hitzebeständige Material	19	Hochtemperaturlegierungen	Vergütet (Eisen basiert)	200	20-45	20-40	0.1-0.2
	20		Gealtert (Eisen basiert)	280	20-30	20-30	0.04-0.10
	21		Vergütet (Nickel oder Cobalt basiert)	250	15-20	15-20	0.04-0.10
	22		Gealtert (Nickel oder Cobalt basiert)	350	10-15	10-15	0.04-0.10
	23	Titanlegierungen	Reines 99,5 Ti	400Rm	70-140	70-120	0.04-0.10
24	α+β Legierungen		1050Rm	20-50	20-50	0.04-0.10	
H_(K) Gehärtetes Material	25	Extra harter Stahl	Gehärtet & angelassen	45-50HRC	15-45	15-45	0.06-0.12
	26			51-55HRC	15-40	15-40	0.04-0.08

Sorte

Sorte		Beispiel
VBX	TiCN- beschichtete Hartmetallsorte. Ausgezeichnete Sorte für Stähle und allgemeine Verwendung .	
VTX	TiAlN- beschichtete Hartmetallsorte. Ideal für Edelstähle .	



TMSD

Gewindefräser für tiefe Bohrungen



TMSD - Gewindefräser für tiefe Bohrungen

■ Vardex Bestellnummernsystem.....	Seite 276
Schneidplatten	
■ Teilprofil 60°.....	Seite 277
■ Teilprofil 55°.....	Seite 278
■ Trapez.....	Seite 279
Trägerkörper	
■ Weldon-Schaft (Mini L).....	Seite 280
■ Zylindrischer Hartmetallschaft (Mini L).....	Seite 281
■ Weldon-Schaft (U typ).....	Seite 282
■ Zylindrischer Hartmetallschaft (U typ).....	Seite 283
■ Zylinderschaft (U typ).....	Seite 284
■ Fräsköpfe (U typ).....	Seite 285
■ Zylinderschaft (A typ).....	Seite 286
Technische Daten	
■ Empfohlene Schnittgeschwindigkeiten und Zahnvorschübe.....	Seite 287



Eine mehrschneidige, produktive und wirtschaftliche Lösung für Gewindefräsoptionen in tiefen Bohrungen.

weicher Schnitt

- Reduzierte Leistungsaufnahme durch Schneidplattenauslegung für einzelnen Gewindegang

Grosser Teilungsbereich

- Teilprofil

Kostengünstig

- Bis zu 3 Schneidkanten pro Schneidplatte
- Sehr hoher Zahnvorschub

Schnelle Bearbeitung

- Schneidenanzahl bis zu 7 (Schneidplatten)

Extreme Einsatztiefe

- Bis zu 144 mm (200 mm bei Fräsköpfen)

Schneidendurchmesser

- Ab 13 mm

Innere Kühlmittelzufuhr

- Zur besseren Spanabfuhr und Kühlung der Schneidkanten

TMSD

Gewindefräser für tiefe Bohrungen

Eine mehrschneidige, produktive und wirtschaftliche Lösung für Gewindefräsoperationen in tiefen Bohrungen.

Mini-L Für kleine Bohrungen

Weldon-Schaft



nutzbare Einsatztiefe (L1) 29-42
Schneidendurchmesser (D2) 13-17.7
Zähnezahl (Z) 1-3

Zylindrischer Hartmetallschaft



nutzbare Einsatztiefe (L1) 20-65
Schneidendurchmesser (D2) 13-17.7
Zähnezahl (Z) 1-3

U Typ Für große Teilungen

Weldon-Schaft



nutzbare Einsatztiefe (L1) 40-120
Schneidendurchmesser (D2) 14.75-42
Zähnezahl (Z) 1-4

Zylindrischer Hartmetallschaft



nutzbare Einsatztiefe (L1) 25-65
Schneidendurchmesser (D2) 14.75-20.65
Zähnezahl (Z) 1-2

Zylinderschaft



nutzbare Einsatztiefe (L1) 40-144
Schneidendurchmesser (D2) 23.3-36.5
Zähnezahl (Z) 2-4

Fräskopf



nutzbare Einsatztiefe (L1) Max. 200
Schneidendurchmesser (D2) 42-98
Zähnezahl (Z) 4-7

A Typ Für Grundlochbearbeitungen

Zylinderschaft







nutzbare Einsatztiefe (L1) 50-144
Schneidendurchmesser (D2) 26-35.3
Zähnezahl (Z) 3

Vardex Bestellnummernsystem

TMSD Schneidplatten

2	U	I	DB	60	TM	VBX
1	2	3	4	5	6	7

1 - Plattengröße 5L - IC5.0L mm 2 - IC1/4" 3 - IC3/8" 4 - IC1/2" 	2 - Schneidplattentype U -  A -  L - 	3 - Art der Schneidplatte I - Innengewinde	4 - Teilung Vollprofil - Teilung mm G/Z 2.0-5.0 - Teilprofil - Teilungsbereich mm G/Z DA 0.5-1.5 48-16 DB 1.5-2.0 16-12 DC 2.5-4.0 10-6 DD 2.0-2.5 9-12 DE 2.5-3.5 10-7 DH 4.0-6.0 6-4 DK 6.0-8.0 4-3 DL - 11-7 DM 2.5 10 DN 1.0-2.0 24-11 DP 1.5-3.0 16-8 DR - 26-14 DT 2.0-4.0 12-6	5 - Norm 60° - Teilprofil 60° 55° - Teilprofil 55° TR- Trapez nach DIN 103	6 - System TM	7 - Hartmetallsorte VBX, VTX
--	--	--	--	--	-------------------------	--

TMSD Schaftfräser

C	TM	2	S	C	14	C	17	-	65	-	2	U
1	2	3	4	5	6	7	8		9		10	11

1 - Schaftart Leer - Stahl C - Hartmetallschaft	2 - System TM	3 - Anzahl der Schneiden 1-4	4 - Schneidplattenart S - für spiralisierte Bearbeitung	5 - Kühlung C - innere Kühlmittelzufuhr	6 - Schaftdurchmesser 9.5 - 40	7 - Schaftform W - Weldon C - Zylinderschaft	8 - Schneidendurchmesser 13 - 42
--	-------------------------	--	---	---	--	---	--

9 - nutzbare Einsatztiefe 29 - 144	10 - Schneidplattengröße 5L - IC5.0L mm 2 - IC1/4" 3 - IC3/8" 4 - IC1/2"	11 - Schneidplattentype U A L	7 - Schneidplattengröße 3 - IC3/8" 4 - IC1/2"
--	---	---	--

TMSD Fräskopf

TM	4	S	C		D42	-	16	-	3	U
1	2	3	4		5		6		7	8

1 - System TM	2 - Anzahl der Schneiden 4-7	3 - Schneidplattenart S - für spiralisierte Bearbeitung	4 - Kühlung C - innere Kühlmittelzufuhr	5 - Schneidendurchmesser 42 - 98	6 - Aufnahmebohrungsdurchmesser 16, 22, 27, 32
-------------------------	--	---	---	--	--

8 - Schneidplattentype U

TMSD - Teilprofil 60°

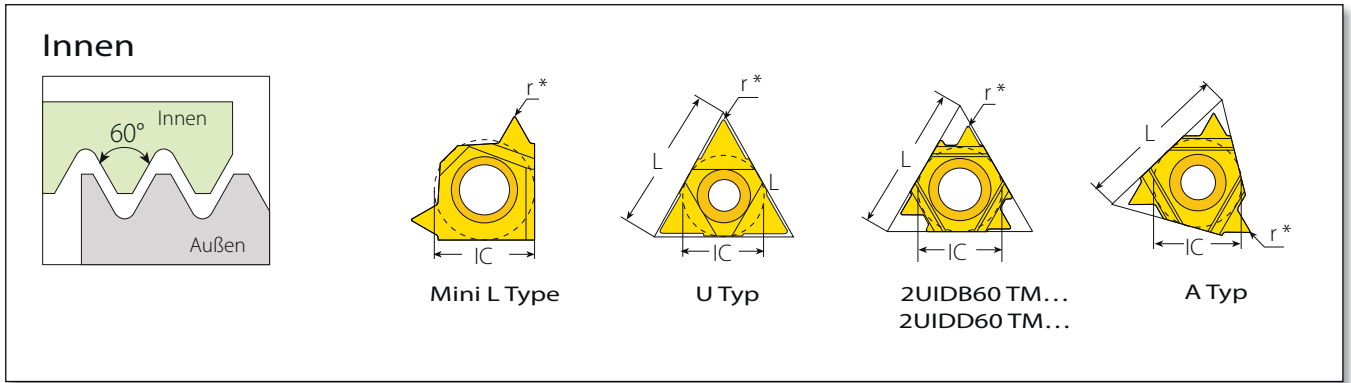

Mini-L



Plattengröße		Teilung		Bestellnummer	Maße (mm)	
IC	L mm	mm	G/Z	Innen	r*	Trägerkörper
5.0L	-	0.5-1.5	48-16	5LIDA60 TM...	0.04	TM.SC...5L
		1.0-2.0	24-11	5LIDN60 TM...	0.06	CTM. SC...5L

U Typ



Plattengröße		Teilung		Bestellnummer	Maße (mm)	
IC	L mm	mm	G/Z	Innen	r*	Trägerkörper
1/4"U	11	0.5-1.5	48-16	2UIDA60 TM...	0.05	TM.SC...2U
		1.5-2.0	16-12	2UIDB60 TM...	0.06	CTM. SC...2U
		2.0-2.5	9-12	2UIDD60 TM...	0.11	CTM2SC 14C17-65-2U
		2.5	10	2UIDM60 TM...	0.11	
3/8"U	16	2.5-4.0	10-6	2UIDC60 TM...	0.14	TM.SC...2U CTM. SC...2U
		1.5-2.0	16-12	3UIDB60 TM...	0.06	TM.SC...3U
		2.5-3.5	10-7	3UIDE60 TM...	0.14	
1/2"U	22	4.0-6.0	6-4	3UIDH60 TM...	0.25	TM.SC D...4U
6.0-8.0	4-3	4UIDK60 TM...	0.30			

A Typ



Plattengröße		Teilung		Bestellnummer	Maße (mm)	
IC	L mm	mm	G/Z	Innen	r*	Trägerkörper
1/4"A	11	1.5-3.0	16-8	2AIDP60 TM...	0.06	TM.SC...2A
3/8"A	16	2.0-4.0	12-6	3AIDT60 TM...	0.08	TM.SC...3A

* Der angegebene Radius (r) beschreibt nur die Spitze der Schneidplatte.

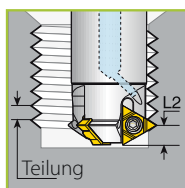

U Typ
Für große Teilungen

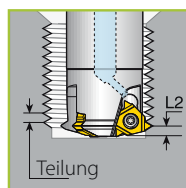

A Typ
Für Kernlochbohrungen

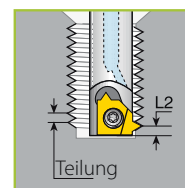

Mini L Typ
Für kleine Bohrungen und Bearbeitungen
nahe dem Bohrungsgrund

TMSD - Teilprofil 55°

Innen

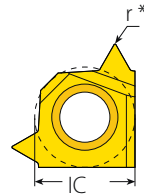
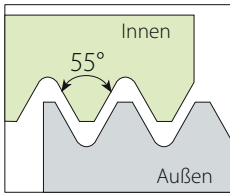

Mini L Type

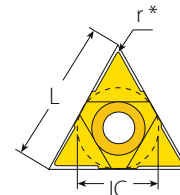

U Typ

Mini-L



Plattengröße	Teilung	Bestellnummer	Maße (mm)	Trägerkörper
IC	G/Z	Innen	r*	
5.0L	26-14	5LIDR55 TM...	0.10	TM.SC...5L CTM. SC...5L

U Typ



Plattengröße		Teilung	Bestellnummer	Maße (mm)	Trägerkörper
IC	L mm	G/Z	Innen	r*	
1/4"U	11	48-16	2UIDA55 TM...	0.11	TM.SC...2U CTM. SC...2U
		16-12	2UIDB55 TM...	0.08	
		11-7	2UIDL55 TM...	0.24	
3/8"U	16	16-12	3UIDB55 TM...	0.08	TM.SC...3U
		11-7	3UIDL55 TM...	0.24	
1/2"U	22	4-3	4UIDK55 TM...	0.50	TM.SC...4U

* Der angegebene Radius (r) beschreibt nur die Spitze der Schneidplatte.

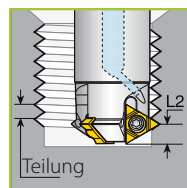

U Typ
Für große Teilungen

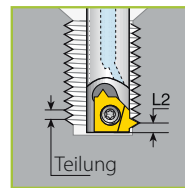

Mini L Typ
Für kleine Bohrungen und
Bearbeitungen nahe dem
Bohrungsgrund

TMSD - Trapez

Innen

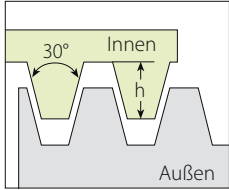

Norm: DIN 103
Toleranzklasse: 7e/7H

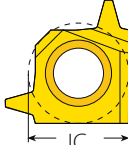

Mini L Type

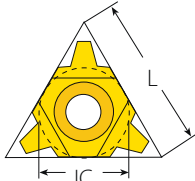

U Typ

Mini-L



Plattengröße	Teilung	Bestellnummer	Anwendung	Trägerkörper
IC	mm	Innen	Innen	
5.0L	2.0	5LI2.0TR-1 TM...	TR16x2, TR20x2	siehe Seiten 280-281
		5LI2.0TR-2 TM...	TR18x2	

U Typ



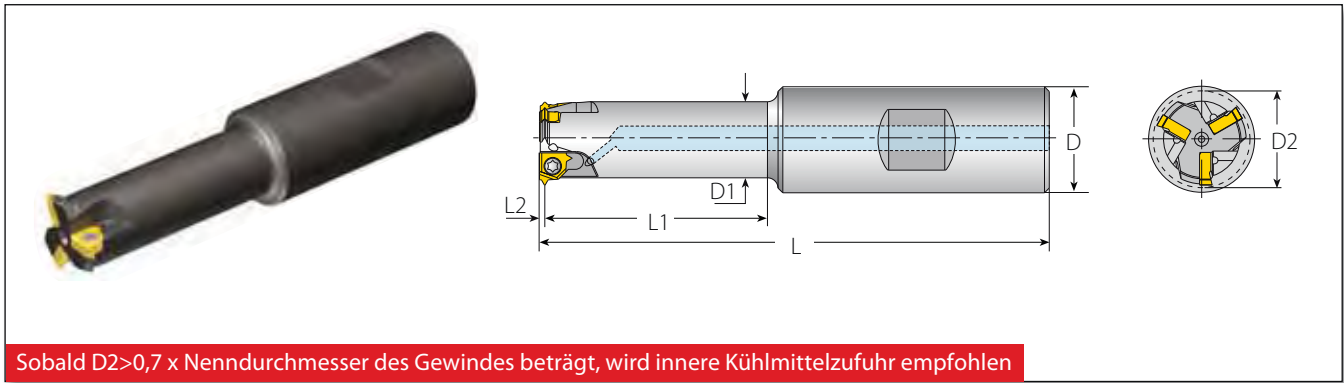

Plattengröße	Teilung	Bestellnummer	Anwendung	Trägerkörper	
IC	L mm	mm	Innen	Innen	
1/4"U	11	3.0	2UI3TR-1 TM...	(TR22-TR30)x3	siehe Seiten 282-283
			2UI3TR-2 TM...	(TR32-TR60)x3	
		4.0	2UI4TR-1 TM...	(TR20-TR28)x4	
			2UI4TR-2 TM...	(TR65-TR110)x4	
		5.0	2UI5TR-1 TM...	TR22x5; TR28x5	
			2UI5TR-2 TM...	TR24x5; TR26x5	

TMSD Standardschaftfräser – Weldon-Schaft (Mini-L Type)



Weldon-Schaft für Mini-L Schneidplatten

Weldon-Schaft für Mini-L Schneidplatten									Ersatzteile	
Plattengröße	Bestellnummer	Maße (mm)					Zähnezahl			
IC		L	L1	L2	D	D1	D2	Z	Plattenspannschraube	Torx Schlüssel
5.0L	TM1SC 16W13-29-5L	81	29		16	9.8	13	1	SN5LTR	K7T
	TM2SC 16W14-33-5L	85	33	1.1	16	10.3	13.5	2		
	TM3SC 20W18-42-5L	96	42		20	14.3	17.7	3		

Gewindegewandbereich für Mini-L Type Schaftfräser (Weldon-Schaft)

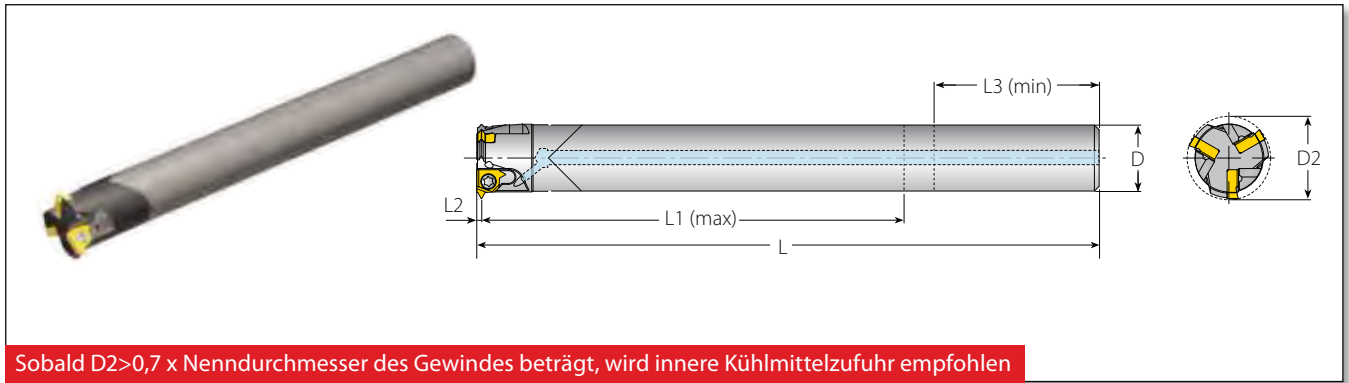

Trägerkörper	Anwendungsbereich Ø						
	D2	ISO Regelgewinde	ISO Feingewinde	UN/UNF/UNEF/UNS	BSP(G)	Teilprofil 55°	Trapez
TM1SC 16W13-29-5L	13	M16x2	M14x0.5; M14x0.75; M14.5x1.0; M15x1.5; M17x2.0	1/16-32UN; 1/16-28UN; 1/16-27UNS; 1/16-24UNEF; 5/8-20UN; 5/8-18UNF; 5/8-16UN; 5/8-14UNS; 5/8-12UN	3/8-19	5/8-14	TR16X2; TR18X2
TM2SC 16W14-33-5L	13.5	M16x2	M15x0.5; M15x0.75; M15x1.0; M16x1.5; M17x2.0	5/8-32UN; 5/8-28UN; 5/8-27UNS; 5/8-24UNEF; 5/8-20UN; 5/8-18UNF; 5/8-16UN; 5/8-14UNS; 11/16-12UN	3/8-19	11/16-14	TR16X2; TR18X2
TM3SC 20W18-42-5L	17.7	-	M19x0.5; M19x0.75; M19x1.0; M20x1.5; M20x2.0	3/4-32UN; 3/4-28UN; 7/8-27UNS; 3/4-24UNEF; 13/16-20UNEF; 7/8-18UNS; 13/16-16UN; 7/8-14UNF; 13/16-12UN	1/2-14	-	TR20X2

TMSD Standardschaftfräser – zylindrischer Hartmetallschaft (Mini-L Type)



zylindrischer Hartmetallschaft für Mini- L Schneidplatten

Ersatzteile

Plattengröße	Bestellnummer	Maße (mm)			Zähnezahl					
IC		L	L1 (max)	L2	L3 (min)	D	D2	Z	Plattenspannschraube	Torx Schlüssel
5.0L	CTM1SC 09C13-43-5L	109	43		20	9,5	13	1	SN5LTR	K7T
	CTM2SC 10C14-50-5L	116	50	1.1	22	10	13.5	2		
	CTM3SC 14C18-65-5L	132	65		30	14	17.7	3		



Gewindeanwendungsbereich für Mini-L Type Schaftfräser (zylindrischer Hartmetallschaft)

Trägerkörper	Anwendungsbereich Ø						
	D2	ISO Regelgewinde	ISO Feingewinde	UN/UNF/UNEF/UNS	BSP(G)	Teilprofil 55°	Trapez
CTM1SC 09C13-43-5L	13	M16x2	M14x0.5; M14x0.75; M14.5x1.0; M15x1.5; M17x2.0	3/16-32UN; 3/16-28UN; 3/16-27UNS; 3/16-24UNEF; 5/8-20UN; 5/8-18UNF; 5/8-16UN; 5/8-14UNS; 5/8-12UN	3/8-19	5/8-14	TR16X2; TR18X2
CTM2SC 10C14-50-5L	13.5	M16x2	M15x0.5; M15x0.75; M15x1.0; M16x1.5; M17x2.0	3/8-32UN; 3/8-28UN; 3/8-27UNS; 3/8-24UNEF; 5/8-20UN; 5/8-18UNF; 5/8-16UN; 5/8-14UNS; 11/16-12UN	3/8-19	11/16-14	TR16X2; TR18X2
CTM3SC 14C18-65-5L	17.7	-	M19x0.5; M19x0.75; M19x1.0; M20x1.5; M20x2.0	3/4-32UN; 3/4-28UN; 7/8-27UNS; 3/4-24UNS; 13/16-20UNEF; 7/8-18UNS; 13/16-16UN; 7/8-14UNF; 13/16-12UN	1/2-14	-	TR20X2

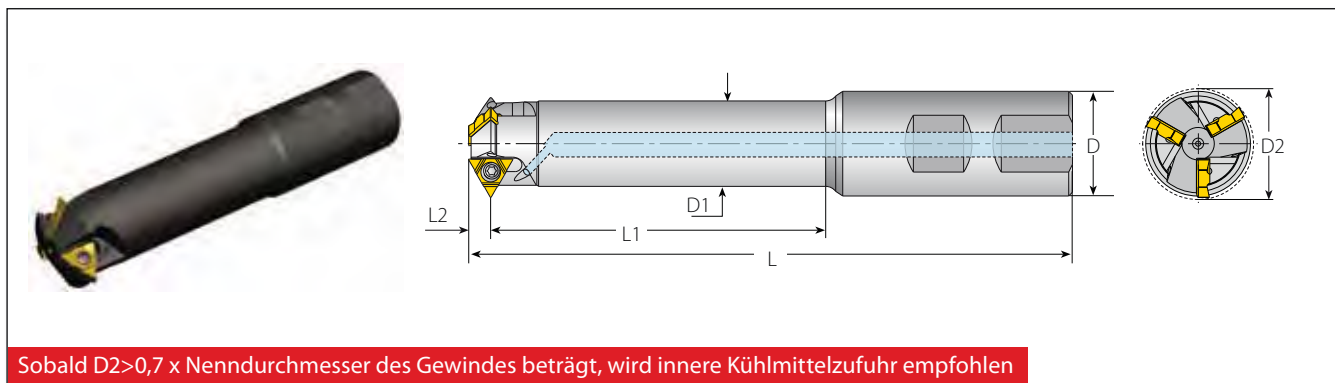
TMSD Standardschaftfräser – Weldon-Schaft (U Type)



Weldon-Schaft für U Schneidplatten

Plattengröße	Bestellnummer	Maße (mm)			Zähnezahl	Ersatzteile		
		L	L1	L2				
1/4"U	TM1SC 16W15-40-2U	95	40	5.4	16	11	SN2T	HK2T
	TM2SC 25W21-60-2U	123	60		25	16		
	TM2SC 25W23-70-2U	135	70		25	17.7		
	TM3SC 25W26-80-2U	147	80		25	20.4		
	TM4SC 32W31-95-2U	164	95		32	25.7		
3/8"U	TM3SC 32W36-95-3U	166	95	8.0	32	29	SA3T	HK3T
	TM4SC 40W42-120-3U	201	120		40	34.2	SN3T	

Gewindeanwendungsbereich für U Type Schaftfräser (Weldon-Schaft)



Trägerkörper	Anwendungsbereich Ø							
	D2	ISO Regelgewinde	ISO Feingewinde	UNC	UN/UNF/UNEF/UNS	BSP(G)	Teilprofil 55°	Trapez
TM1SC 16W15-40-2U	14.75*	M18x2.5, M24x3.0	M16x0.5, M16x0.75, M16x1.0, M17x1.25, M17x1.5, M17x2.0	3/4-10	5/8-32UN, 5/8-28UN, 5/8-27UNS, 11/16-24UN, 11/16-20UN, 11/16-16UN, 3/4-14UNS, 3/4-12UN	3/8-19, 1/2-14, 1-11	11/16-14; 3/4-12; 7/8-11; 3/4-10; 7/8-9; 1-8; 1 1/8-7	TR22x3, TR24x3
TM2SC 25W21-60-2U	20.65*	M24x3.0, M30x3.5	M22x0.5, M22x0.75, M22x1.0, M23x1.25, M23x1.5, M23x2.0	1-8, 1 1/8-7, 1 3/8-6	7/8-32UN, 7/8-28UN, 7/8-27UNS, 7/8-24UNS, 7/8-20UNEF, 1-18UNS, 1 1/8-16UN, 1-14UNS, 1 1/8-12UN, 1-10UNS	3/4-14, 1-11	1-26, 1-20, 1-16, 1-12, 1-10, 1 1/8-9, 1-8, 1 1/8-7	(TR26-TR60x3)
TM2SC 25W23-70-2U	23	M27x3.0, M30x3.5, M36x4.0	M24x0.5, M24x0.75, M25x1.0, M25x1.25, M26x1.5, M26x2.0, M27x2.5	1 1/8-7	1-32UN, 1-28UN, 1-27UNS, 1-24UNS, 1-20UNEF, 1-18UNS, 1-16UN, 1-14UNS, 1-12UNF, 1 1/8-10UNS, 1 1/8-8UN	3/4-14, 1-11	1-26, 1-20, 1-16, 1 1/8-12, 1 1/8-9, 1 1/8-7	-
TM3SC 25W26-80-2U	26	M30x3.5, M36x4.0	M27x0.5, M27x0.75, M28x1.0, M28x1.25, M28x1.5, M29x2.0, M30x2.5, M30x3.0	1 1/4-7, 1 3/8-6	1 1/8-28UN, 1 1/8-24UNS, 1 1/8-20UN, 1 1/8-18UNEF, 1 1/8-16UN, 1 1/8-14UNS, 1 1/8-12UNF, 1 1/4-10UNS, 1 3/8-8UN	7/8-14, 1-11	1 1/8-26, 1 1/8-20, 1 3/8-16, 1 3/8-12, 1 3/8-8, 1 1/4-7	-
TM4SC 32W31-95-2U	31	M36x4.0	M32x0.5, M32x0.75, M33x1.0, M33x1.25, M33x1.5, M34x2.0, M34x2.5, M35x3.0, M36x3.5	1 1/2-6	1 3/8-28UN, 1 3/8-24UNS, 1 3/8-20UN, 1 3/8-18UNEF, 1 3/8-16UN, 1 3/8-14UNS, 1 3/8-12UNF, 1 3/8-10UNS, 1 3/8-8UN	1 1/8-11	1 3/8-26, 1 3/8-20, 1 3/8-16, 1 3/8-12, 1 7/8-8	-
TM3SC 32W36-95-3U	36.5	M42x4.5, M48x5.0, M56x5.5, M64x6.0	M39x1.5, M39x2.0, M40x2.5, M41x3.0, M42x3.5, M42x4.0	1 3/4-5, 2-4.5, 2 1/2-4	1 1/8-16UN, 1 1/8-14UNS, 1 1/8-12UN, 1 1/8-10UNS, 1 1/8-8UN, 1 1/8-6UN	1 1/4-11	1 1/8-16, 1 1/8-12, 1 3/8-8, 2 1/4-6, 1 3/4-5	-
TM4SC 40W42-120-3U	42	M48x5.0, M56x5.5, M64x6.0	M45x1.5, M45x2.0, M46x2.5, M48x3.0, M48x3.5, M48x4.0	2-4.5, 2 1/2-4	1 3/4-16UN, 1 3/4-14UNS, 1 13/16-12UN, 1 13/16-8UN, 1 15/16-6UN	1 1/2-11	1 7/8-16, 1 7/8-12, 1 7/8-8, 1 7/8-6, 2-4.5	-

* Für die CNC Programmierung bei TR Schneidplatten - D2 + 0,25mm

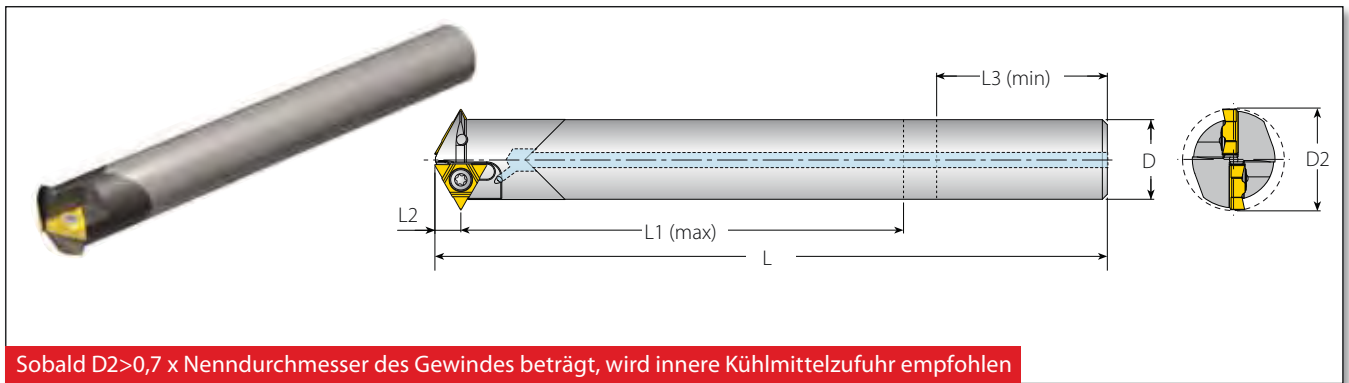
TMSD Standardschaftfräser - Zylindrischer Hartmetallschaft (U-Type)



zylindrischer Hartmetallschaft für U Schneidplatten

Plattengröße	Bestellnummer	Maße (mm)							Zähnezahl	Ersatzteile	
		L	L1 (max)	L2	L3 (min)	D	D2	Z			
IC											
1/4"U	CTM1SC 08C15-40-2U	109	40	5.4	18	8	14.75*	1	SN2T	HK2T	
	CTM1SC 11C15-60-2U	120	60	5.4	25	10.7	14.75*	1			
	CTM2SC 14C17-65-2U**	132	65	3.4	30	14	17.2**	2			
	CTM2SC 14C21-65-2U	136	65	5.4	30	14	20.65*	2			
	CTM2SC 16C21-80-2U	135	80	5.4	34	16	20.65*	2			

Gewindeanwendungsbereich für U Type Schaftfräser (Zylindrischer Hartmetallschaft)

Trägerkörper	Anwendungsbereich Ø							
	D2	ISO Regelgewinde	ISO Feingewinde	UNC	UN/UNF/UNEF/UNS	BSP(G)	Teilprofil 55°	Trapez
CTM1SC 08C15-40-2U	14.75*	M18x2.5, M24x3.0, M30x3.5, M36x4.0	M16x0.5, M16x0.75, M16x1.0, M17x1.25, M17x1.5, M17x2.0	3/4-10, 7/8-9, 1-8, 1 1/8-7, 1 3/8-6	5/8-32UN, 5/8-28UN, 5/8-27UNS, 1 1/16-24UNEF, 1 1/16-20UN, 1 1/16-16UN, 3/4-14UNS, 1 1/16-12UN	1/2-14, 1-11	1 1/16-26, 1 1/16-20, 1 1/16-16, 1 1/16-14, 3/4-12, 7/8-11, 3/4-10, 7/8-9, 1-8, 1 1/8-7	TR22x3, TR24x3, TR20x4, TR22x5, TR24x5, TR26x5, TR28x5
CTM1SC 11C15-60-2U	14.75*	M18x2.5, M24x3.0	M16x0.5, M16x0.75, M16x1.0, M17x1.25, M17x1.5, M17x2.0	3/4-10, 7/8-9, 1-8	5/8-32UN, 5/8-28UN, 5/8-27UNS, 1 1/16-24UNEF, 1 1/16-20UN, 1 1/16-16UN, 3/4-14UNS, 1 1/16-12UN	1/2-14, 1-11	1 1/16-26, 1 1/16-20, 1 1/16-16, 1 1/16-14, 3/4-12, 7/8-11, 3/4-10, 7/8-9	TR22x3, TR24x3
CTM2SC 14C17-65-2U	17.2**	M20x2.5, M22x2.5	M21x2.0	7/8-9	7/8-10UNS, 1 3/16-12UN	-	-	-
CTM2SC 14C21-65-2U	20.65*	M24x3.0, M30x3.5, M36x4.0	M22x0.5, M22x0.75, M22x1.0, M23x1.25, M23x1.5, M23x2.0	1-8, 1 1/8-7, 1 3/8-6	5/8-32UN, 5/8-28UN, 5/8-27UNS, 7/8-24UNS, 7/8-20UNEF, 1-18UNS, 1 5/16-16UN, 1-14UNS, 1 5/16-12UN, 1-10UNS	3/4-14, 1-11	1-26, 1-20, 1-16, 1-12, 1-10, 1 1/8-9, 1-8, 1 1/8-7	(TR26-TR60)x3, TR28x4, (TR65-TR110)x4, TR28x5
CTM2SC 16C21-80-2U	20.65*	M24x3.0, M30x3.5	M22x0.5, M22x0.75, M22x1.0, M23x1.25, M23x1.5, M23x2.0	1-8, 1 1/8-7, 1 3/8-6	5/8-32UN, 5/8-28UN, 5/8-27UNS, 7/8-24UNS, 7/8-20UNEF, 1-18UNS, 1 5/16-16UN, 1-14UNS, 1 5/16-12UN, 1-10UNS	3/4-14, 1-11	1-26, 1-20, 1-16, 1-12, 1-10, 1 1/8-9, 1-8, 1 1/8-7	(TR26-TR60)x3

* Für die CNC Programmierung bei TR Schneidplatten - D2 + 0,25mm



** Für Schneidplatten 2UIDD60 TM... Einsatz für CNC Programm (D2+ 0,7mm)
Für die CNC Programmierung bei Schneidplatte 2UIDD60 TM - D2 + 0,7mm

TMSD

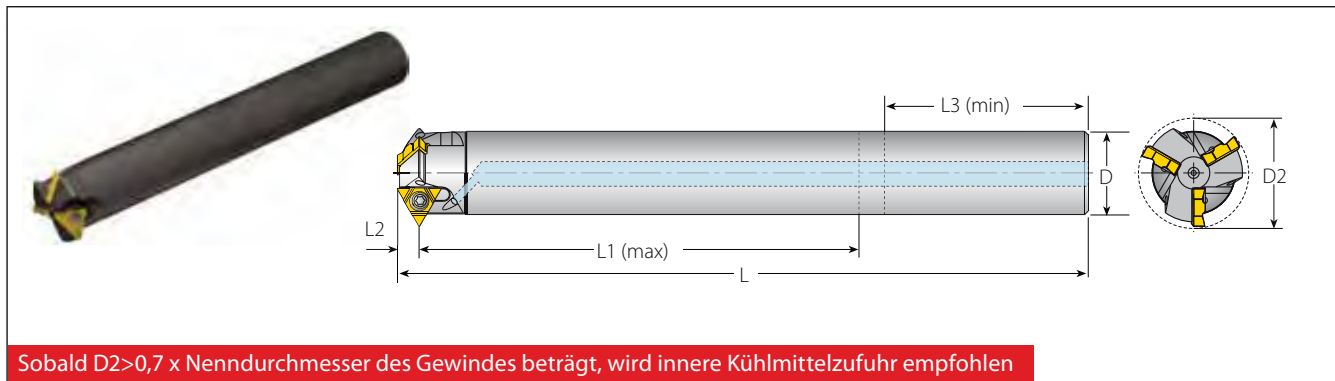
TMSD Standardschaftfräser - Zylindrischer Schaft (U-Type)



Zylindrischer Schaft für U-Type - Schneidplatten

Plattengröße	Bestellnummer	Maße (mm)						Zähnezahl	Ersatzteile	
		L	L1 (max)	L2	L3 (min)	D	D2			
IC		L	L1 (max)	L2	L3 (min)	D	D2	Z		
1/4"U	TM2SC 18C23-86-2U	166	86	5.4	40	18	23.3	2	SN2T	HK2T
	TM3SC 20C26-105-2U	186	105	5.4	40	20	26	3		
	TM4SC 25C31-115-2U	196	115	5.4	46	25	31	4		
3/8"U	TM3SC 28C36-144-3U	222	144	8.0	60	28	36.5	3	SA3T	HK3T

Gewindeanwendungsbereich für U Type Schaftfräser (Zylindrischer Schaft)

Trägerkörper	Anwendungsbereich Ø						
	D2	ISO Regelgewinde	ISO Feingewinde	UNC	UN/UNF/UNEF/UNS	BSP(G)	Teilprofil 55°
TM2SC 18C23-86-2U	23.3	M27x3.0, M30x3.5, M36x4.0	M24x0.5, M25x0.75, M25x1.0, M25x1.25, M26x1.5, M26x2.0, M27x2.5	1 1/8-7	1-32UN, 1-28UN, 1-27UN, 1-24UNS, 1-20UNEF, 1-18UNS, 1-16UN, 1-14UNS, 1 1/16-12UN, 1 1/16-10UNS, 1 1/16-8UN	3/4-14, 1-11	1-26, 1-20, 1 1/8-16, 1 1/8-12, 1 1/8-9, 1 1/8-7
TM3SC 20C26-105-2U	26	M30x3.5, M36x4.0	M27x0.5, M27x0.75, M28x1.0, M28x1.25, M28x1.5, M29x2.0, M30x2.5, M30x3.0	1 1/4-7, 1 3/8-6	1 1/8-28UN, 1 1/8-24UNS, 1 1/8-20UN, 1 1/8-18UNEF, 1 1/8-16UN, 1 1/8-14UNS, 1 1/8-12UNF, 1 3/8-10UNS, 1 1/16-8UN	7/8-14, 1-11	1 1/8-26, 1 1/8-20, 1 3/16-16, 1 3/16-12, 1 3/16-8, 1 1/4-7
TM4SC 25C31-115-2U	31	M36x4.0	M32x0.5, M32x0.75, M33x1.0, M33x1.25, M33x1.5, M34x2.0, M34x2.5, M35x3.0, M36x3.5	1 1/2-6	1 5/16-28UN, 1 1/2-24UNS, 1 1/2-20UN, 1 1/2-18UNEF, 1 3/8-16UN, 1 3/8-14UNS, 1 3/8-12UNF, 1 3/8-10UNS, 1 1/16-8UN	1 1/8-11	1 5/16-26, 1 5/16-20, 1 3/8-16, 1 3/8-12, 1 1/16-8
TM3SC 28C36-144-3U	36.5	M42.5x4.5, M48x5.0, M56x5.5, M64x6.0	M39x1.5, M40x2.5, M41x3.0, M42x3.5, M42x4.0	1 3/4-5, 2-4.5, 2 1/2-4	1 5/16-16UN, 1 5/8-14UNS, 1 1/16-12UN, 1 5/8-10UNS, 1 5/8-8UN, 1 5/8-6UN	1 1/4-11	1 5/8-16, 1 5/8-12, 1 5/8-8, 2 1/4-6, 1 3/4-5

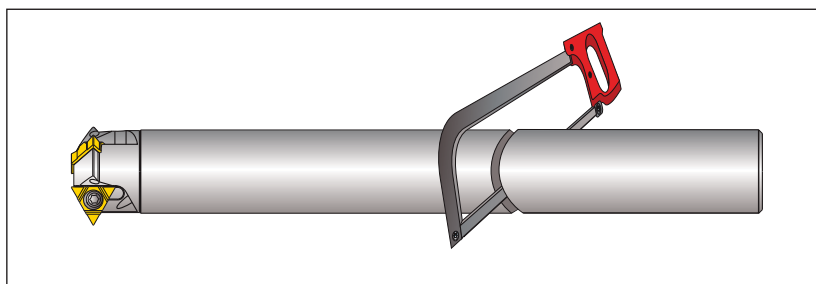

Die Länge von zylindrischen Schäften kann in professioneller Weise reduziert werden, um die Ratter- bzw. Vibrationsneigung zu verringern.
Anmerkung: Die Spannlänge des Schaftes im Futter sollte mindestens L3 betragen.

TMSD Fräskopf (U Type)

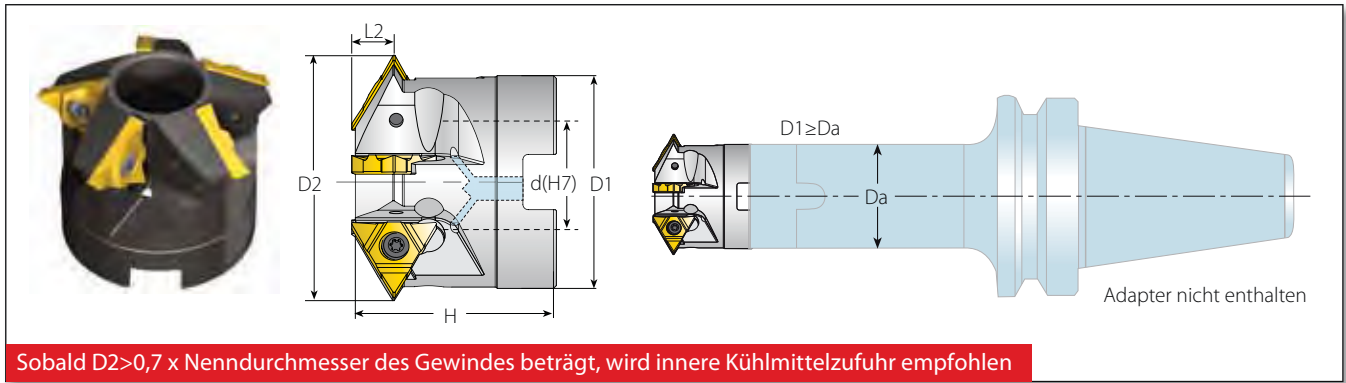

Fräskopf für U-Type-Schneidplatten

Fräskopf für U-Type-Schneidplatten								Ersatzteile			
Plattengröße	Bestellnummer	Maße (mm)					Zähnezahl				
IC		D1	D2	d(H7)	H	L2	Z	Plattenspannschraube	Torx Schlüssel	Aufnahme	Halteschraube
3/8"U	TM4SC D42-16-3U	34	42	16	40	8.0	4	SN3T	HK3T	SA5T-C5 (M8x1.25x28)	TK5T
	TM5SC D48-22-3U	40	48	22	40	8.0	5			M10x1.50x35	-
	TM6SC D56-22-3U	48	56	22	40	8.0	6			-	-
1/2"U	TM6SC D88-27-4U	76	88	27	50	10.8	6	SA4T	HK4T	M12x1.75x40	-
	TM7SC D98-32-4U	85	98	32	55	10.8	7			M16x2.00x40	

Gewindeanwendungsbereich für U- Type- Fräskopf



Trägerkörper		Anwendungsbereich Ø					
	D2	ISO Regelgewinde	ISO Feingewinde	UNC	UN/UNF/UNEF/UNS	BSP(G)	Teilprofil 55°
TM4SC D42-16-3U	42	M48x5.0, M56x5.5, M64x6.0,	M45x1.5, M45x2.0, M46x2.5, M48x3.0, M48x3.5, M48x4.0	2-4.5, 2½ - 4	1¼-16UN, 1¼-14UNS, 1½-16UN, 1½-8UN, 1½-6UN	1½ - 11	1⅞-16, 1⅞-12, 1⅞-8, 1⅞-6, 2-4.5
TM5SC D48-22-3U	48	M56x5.5, M64x6.0	M52x1.5, M52x2.0, M52x2.5, M52x3.0, M55x4.0	2¼ - 4.5, 2½ - 4	2-16UN, 2-14UN, 2-12UN, 2¼-10UNS, 2½-8UN, 2½-6UN	1¾ - 11	2-16, 2¼-12, 2¼-8, 2¼-6, 3-5, 3½-4.5, 2¼-4
TM6SC D56-22-3U	56	M64x6.0	M60x1.5, M60x2.0, M60x2.5, M60x3.0, M64x4.0	2½ - 4	2⅝-16UN, 2⅝-14UN, 2⅝-12UN, 2½-10UNS, 2⅝-8UN, 2½-6UN	2 - 11	2½-16, 2½-12, 2½-8, 2¼-6, 3-5, 3½-4.5, 4¼-4
TM6SC D88-27-4U	88	-	M95x6.0, M130x8	4- 4	4¼-4UN	3½ - 11	4-3, 4¼-4
TM7SC D98-32-4U	98	-	M105x6.0, M130x8	-	4¼-4UN	4 - 11	4¼-4

TMSD

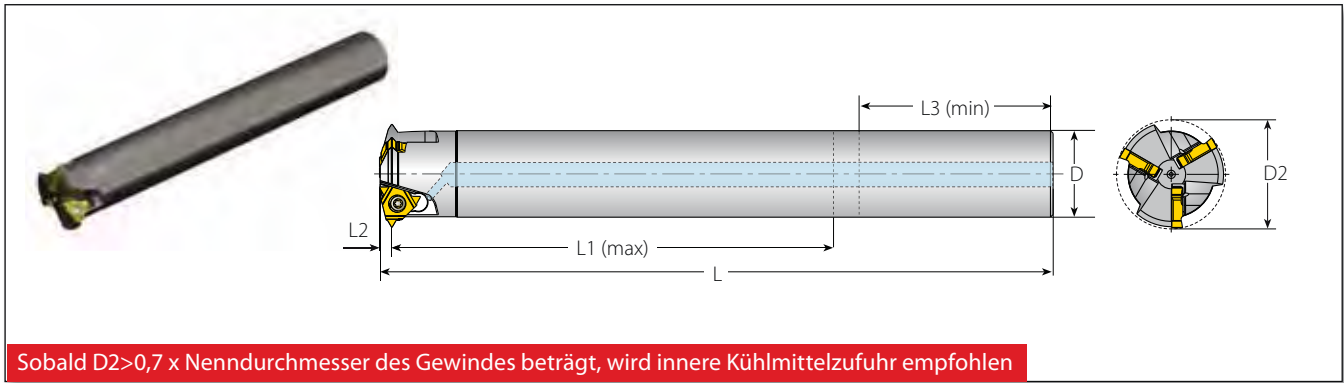
TMSD Standardschaftfräser - Zylindrischer Schaft (A-Type)



Zylindrischer Schaft für A-Type-Schneidplatten

Zylindrischer Schaft für A-Type-Schneidplatten									Ersatzteile	
Plattengröße	Bestellnummer	Maße (mm)						Zähnezahl		
IC		L	L1 (max)	L2	L3 (min)	D	D2	Z	Plattenspannschraube	Torx Schlüssel
1/4"A	TM3SC 20C26-105-2A	184	105	3.0	40	20	26	3	SN2T	HK2T
3/8"A	TM3SC 28C35-144-3A	218	144	4.0	46	28	35.3	3	SA3T	HK3T

Gewindeanwendungsbereich für A-Type Schaftfräser (Zylindrischer Schaft)

Trägerkörper	Anwendungsbereich Ø					
	D2	ISO Regelgewinde	ISO Feingewinde	UNC	UN/UNF/UNEF/UNS	BSP(G)
TM3SC 20C26-105-2A	26	-	M28x1.5, M29x2.0, M30x2.5, M30x3.0	-	1/8-16UN, 1/8-14UNS, 3/16-12UN, 1/4-10UNS, 3/16-8UN	-
TM3SC 28C35-144-3A	35.3	-	M38x2.0, M39x2.5, M39x3.0, M40x4.0	-	1/8-12UN, 1/8-10UNS, 1/8-8UN, 1/8-6UN	-

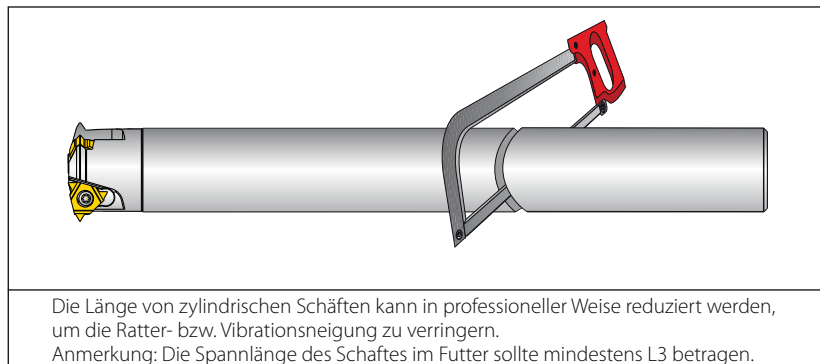

Empfohlene Sorten und Schnittgeschwindigkeiten Vc [m/min] und Vorschübe fz [mm/Zahn]

Materialgruppe	Vardex Nr.	Material	Härte Brinell HB	Vc [m/min]		Vorschub* fz [mm/Zahn] bei einem Schneidendurchmesser (D2)			
				VBX	VTX	13-23	24-42	Fräskopf	
P Stahl	1	Unlegierter Stahl	Geringer Kohlenstoffanteil (C=0.1-0.25%)	125	100-210	90-180	0.20-0.32	0.30-0.50	0.30-0.75
	2		Mittlerer Kohlenstoffanteil (C= 0.25- 0.55%)	150	100-180	90-170	0.20-0.32	0.30-0.50	0.30-0.75
	3		Hoher Kohlenstoffanteil (C= 0.55- 0.85%)	170	100-170	90-160	0.15-0.23	0.25-0.35	0.25-0.52
	4	Niedriglegierter Stahl (Legierungs- Elemente ≤ 5%)	Ungehärtet	180	60-90	90-155	0.17-0.28	0.28-0.45	0.28-0.67
	5		Gehärtet	275	80-150	80-160	0.15-0.28	0.25-0.45	0.25-0.67
	6		Gehärtet	350	70-140	70-150	0.15-0.25	0.25-0.40	0.25-0.60
	7	Hochlegierter Stahl (Legierungs- Elemente > 5%)	Vergütet	200	60-130	70-115	0.15-0.22	0.20-0.30	0.20-0.45
	8		Gehärtet	325	70-110	60-100	0.13-0.21	0.18-0.30	0.18-0.45
	9	Stahlguss	Niedriglegiert (Legierungs- Elemente ≤ 5%)	200	100-170	100-170	0.15-0.22	0.20-0.30	0.20-0.45
	10		Hochlegiert (Legierungs- Elemente > 5%)	225	70-120	70-130	0.12-0.22	0.17-0.30	0.17-0.45
M Edelstahl	11	Edelstahl Ferritisch	Ungehärtet	200	100-170	120-180	0.15-0.22	0.22-0.34	0.22-0.50
	12		Gehärtet	330	100-170	120-180	0.16-0.23	0.21-0.32	0.21-0.48
	13	Edelstahl Austenitisch	Austenitisch	180	70-140	100-140	0.15-0.25	0.25-0.40	0.25-0.60
	14		Super- Austenitisch	200	70-140	100-140	0.12-0.20	0.17-0.26	0.17-0.39
	15	Edelstahl	Ungehärtet	200	70-140	100-140	0.16-0.24	0.25-0.37	0.25-0.55
	16		Gehärtet	330	70-140	100-140	0.12-0.20	0.17-0.26	0.17-0.39
	17	Edelstahl Guss austenitisch	Austenitisch	200	70-120	100-120	0.15-0.22	0.20-0.30	0.20-0.45
	18		Gehärtet	330	70-120	100-120	0.12-0.20	0.17-0.26	0.17-0.39
K Gußeisen	28	Temperguss	Ferritisch (kurzspanig)	130	60-130	100-120	0.16-0.24	0.25-0.37	0.25-0.55
	29		Perlitisch (langspanig)	230	60-120	80-100	0.15-0.22	0.20-0.30	0.20-0.45
	30	Grauguss	Niedrigfest	180	60-130	80-100	0.15-0.22	0.22-0.34	0.22-0.50
	31		Hochfest	260	60-100	80-100	0.15-0.22	0.20-0.30	0.20-0.45
	32	Kugelgraphitguss	Ferritisch	160	60-125	80-100	0.10-0.20	0.15-0.25	0.15-0.37
	33		Perlitisch	260	50-90	60-90	0.15-0.22	0.20-0.30	0.20-0.45
N_(K) Nichteisen- Metalle Metalle	34	Aluminium- Legierungen Schmiedeeisen	ungealtert	60	100-250		0.30-0.50	0.60-1.00	0.60-1.50
	35		gealtert	100	100-180		0.28-0.50	0.50-0.90	0.50-1.20
	36	Aluminium- Legierungen	Guß	75	150-400		0.28-0.50	0.50-0.90	0.50-1.20
	37		Guß & gealtert	90	150-280		0.25-0.40	0.40-0.60	0.40-0.90
	38	Aluminium- Legierungen	Guß Si 13- 22%	130	80-150		0.28-0.50	0.50-0.90	0.50-1.20
	39	Kupfer und Kupferlegierungen	Messing	90	120-210	100-200	0.30-0.50	0.60-1.00	0.60-1.50
	40		Bronze und bleifreies Kupfer	100	120-210	100-200	0.28-0.50	0.50-0.90	0.50-1.20
	S_(M) Hitzebeständige Material	19	Hochtemperaturlegierungen	Vergütet (Eisen basiert)	200	20-45	20-40	0.09-0.15	0.12-0.22
20		Gealtert (Eisen basiert)		280	20-30	20-30	0.07-0.13	0.10-0.20	0.10-0.30
21		Vergütet (Nickel oder Cobalt basiert)		250	15-20	15-20	0.08-0.15	0.08-0.20	0.08-0.30
22		Gealtert (Nickel oder Cobalt basiert)		350	10-15	10-15	0.08-0.15	0.08-0.20	0.08-0.30
23		Titanlegierungen	Reines 99,5 Ti	400Rm	70-140	70-120	0.07-0.13	0.10-0.20	0.10-0.30
24			α+ β Legierungen	1050Rm	20-50	20-50	0.07-0.13	0.10-0.20	0.10-0.30
H_(K) Gehärtetes Material	25	Extra harter Stahl	Gehärtet & angelassen	45-50HRc	15-45	15-45	0.05-0.12	0.05-0.18	0.05-0.27
	26			51-55HRc	15-40	15-40	0.05-0.12	0.05-0.18	0.05-0.27

* Bei der Verwendung eines Fräskopfes kann der Vorschub um 50 % erhöht werden

Sorte

Sorte	Anwendung
VBX	TiCN- beschichtete Hartmetallsorte. Ausgezeichnete Sorte für Stähle und allgemeine Verwendung.
VTX	TiAlN- beschichtete Hartmetallsorte. Ideal für Edelstähle.





TM Solid

Vollhartmetall-Gewindefräswerkzeuge

> **Werkzeuge**

> **Technische
Daten**



- **Helicool** - Gedralltes Werkzeug mit axialem Kühlmittelaustritt Seite 292
- **Helicool R (HCR)** - Gedralltes Werkzeug mit radialem Kühlmittelaustritt Seite 297
- **Helicool C (HCC)** - Gedralltes Werkzeug mit axialer innerer Kühlmittelzufuhr und Fase Seite 298
- **HTC (Thriller)** - Bohren, Fasen und Gewinden mit innerer Kühlmittelzufuhr Seite 299
- **Helical** - Gedralltes Werkzeug ohne innere Kühlmittelzufuhr Seite 300
- **Tiefe Gewinde schneiden** - Gerade Spannuten für tiefe Bohrungen Seite 304
- **MilliPro** - Minigewindefräser Seite 305
- **MilliPro Dental** - Minigewindefräser für Zahnimplantate Seite 308
- **MilliPro EL** - Minigewindefräser, extra lange Werkzeuge Seite 309
- **MilliPro HD** - Minigewindefräser für harte Materialien Seite 310
- **Gerade** - Gerade genutet Seite 312
- **Sorten und ihre Anwendungen** Seite 317
- **Schnittgeschwindigkeiten und Zahnvorschübe** Seite 318

TM Vollhartmetall

HC		10	082	L15	-	I	1.50	ISO	TM		VTH
1	2	3	4	5		6	7	8	9	10	11

1 - Werkzeugtyp	2 - Anzahl der Zähne	3 - Spannflächendurchmesser	4 - Schneidendurchmesser	5 - Schneidenlänge
HC - Helicool HCR - Helicool R HCC - Helicool C H - Spiral genutet S - Gerade genutet D - Für tiefe Gewinde und MilliPro	1T - 1 Zahn 3T - 3 Zähne (MilliPro) 2L - 2 Zähne Linkslauf (MilliPro HD)	03 - 3.0 mm 04 - 4.0 06 - 6.0 08 - 8.0 10 - 10.0 12 - 12.0 14 - 14.0 16 - 16.0 18 - 18.0 20 - 20.0	0.7 - 19.9 mm	Bis 3xD

7 - Teilung	8 - Norm	9 - System	10 - Anzahl Nuten	11 - Hartmetallsorte
Vollprofil - Teilung mm tpi 0.25-6.0 80-4.5	ISO - ISO Metrisch UN - Amerikanisch UN UNC - UN Regelgewinde UNF - Feingewinde UNEF - UN Extra Feingewinde UNJ - UNJ MJ - MJ BSW - Whit. Regelgewinde BSP - BSP (G) BSF - Whit. Feingewinde BSPT - BSPT NPT - NPT NPTF - NPTF PG - PG	TM TML - Extra Lang	3 - 3 Nuten 5 - 5 Nuten Gerade genutet, wenn zwei Optionen erhältlich sind	VTS VTH
Teilprofil - Teilungsbereich mm tpi				
TA 0.5-0.8 32-56 TB 0.5-1.0 24-56 TC 1.0-1.50 16-24 TD 1.0-1.75 14-24 TF 0.5-1.25 20-48				

HTC - Thriller

HTC	M6	1.0	2D	VTN
1	2	3	4	5

1 - Werkzeugtyp	2 - Gewinde	3 - Teilung	4 - Gewindelänge	5 - Hartmetallsorte
HTC - Bohrgewindefräser	M6 - M12	1 - 1.75mm	2D 2.5D	VTN VTS

Das richtige Werkzeug für das Gewindefräsen!

Minigewindefräser

MilliPro

MilliPro &
MilliPro EL
ab M1.6x0.35 (1-72UNF)



MilliPro HD
Bis zu 62 HRC

MilliPro Dental
ab M1.0x0.25 (0-80UNF)

Lange Gewinde

Tiefes Gewindefräsen

Vollprofil



Teilprofil

Bis 3xD

Normale Anwendung

Gerade genutet



ab M4.5x0.75 (No.8-36UNF)

Höchstleistung

Helicool



ab M3x0.5 (No.10-32UNF)

Radiale Kühlmittelzufuhr

Helicool-R (HCR)



ab M6x1.0

Helicool und Fasen

Helicool-C (HCC)



ab M6x1.0

kostengünstiges Werkzeug

Spiralgenutet



ab M3x0.5 (No.8-36UNF)

Bohren, Gewinden und Fasen

HTC



ab M6x1.0

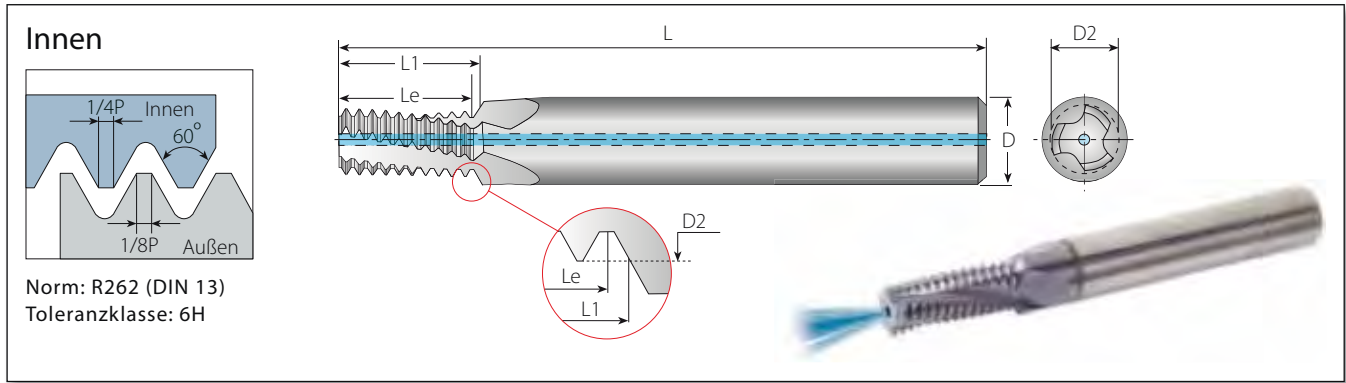

Norm: R262 (DIN 13)
Toleranzklasse: 6H

Gedrahte Werkzeuge mit innerer Kühlmittelzufuhr 1.5 x Do (L1 ≤ 1.5 x Gewindedurchmesser)

Gewinde		Teilung	Bestellnummer	Abmessungen mm					Zähnezahl	Zähne	Bohrungs Ø
M Regel	M Fein	mm	Innen	D	D2	L	Le	L1	Z	Zt	mm
M3x0.5	M3.5-M16x0.5	0.5	HC04024L04-I0.50ISO TM...	4	2.40	45	4.5	4.7	3	9	2.5
M4x0.7		0.7	HC04031L06-I0.70ISO TM...	4	3.15	45	6.3	6.6	3	9	3.3
M5x0.8		0.8	HC04039L07-I0.80ISO TM...	4	3.90	45	7.2	7.6	3	9	4.2
M6x1.0	M8-M40x1.0	1.0	HC06048L09-I1.00ISO TM...	6	4.80	57	9.0	9.5	3	9	5.0
M8x1.25		1.25	HC08065L13-I1.25ISO TM...	8	6.50	61	12.5	13.1	3	10	6.8
M10x1.5	M12-M48x1.5	1.5	HC10082L15-I1.50ISO TM...	10	8.20	73	15.0	15.7	3	10	8.5
M12x1.75		1.75	HC10099L18-I1.75ISO TM...	10	9.90	73	17.5	18.4	4	10	10.2
M14x2.0	M17-M80x2.0	2.0	HC12116L21-I2.00ISO TM...	12	11.60	73	20.0	21.0	4	10	12.0
M16x2.0	M17-M80x2.0	2.0	HC14136L25-I2.00ISO TM...	14	13.60	92	24.0	25.0	4	12	14.0

Gedrahte Werkzeuge mit innerer Kühlmittelzufuhr 2 x Do (L1 ≤ 2 x Gewindedurchmesser)

Gewinde		Teilung	Bestellnummer	Abmessungen mm					Zähnezahl	Zähne	Bohrungs Ø
M Regel	M Fein	mm	Innen	D	D2	L	Le	L1	Z	Zt	mm
M3x0.5	M3.5-M16x0.5	0.5	HC04024L06-I0.50ISO TM...	4	2.40	45	6.0	6.2	3	12	2.5
	M4x0.5	0.5	HC04032L08-I0.50ISO TM...	4	3.20	45	8.0	8.2	3	16	3.5
	M5x0.5	0.5	HC06042L10-I0.50ISO TM...	6	4.20	57	10.0	10.2	3	20	4.5
M4x0.7		0.7	HC04031L08-I0.70ISO TM...	4	3.15	45	8.4	8.7	3	12	3.3
	M6x0.75	0.75	HC06050L12-I0.75ISO TM...	6	5.00	57	12.0	12.4	3	16	5.3
M5x0.8		0.8	HC04039L10-I0.80ISO TM...	4	3.90	45	10.4	10.8	3	13	4.2
M6x1.0	M8-M40x1.0	1.0	HC06048L12-I1.00ISO TM...	6	4.80	57	12.0	12.5	3	12	5.0
	M8x1.0	1.0	HC08067L16-I1.00ISO TM...	8	6.70	61	16.0	16.5	3	16	7.0
	M10x1.0	1.0	HC10087L20-I1.00ISO TM...	10	8.70	73	20.0	20.5	3	20	9.0
	M12x1.0	1.0	HC12107L24-I1.00ISO TM...	12	10.70	73	24.0	24.5	4	24	11.0
M8x1.25		1.25	HC08065L16-I1.25ISO TM...	8	6.50	61	16.2	16.9	3	13	6.8
	M10x1.25	1.25	HC10085L20-I1.25ISO TM...	10	8.50	73	20.0	20.6	3	16	8.8
M10x1.5	M12-M48x1.5	1.5	HC10082L20-I1.50ISO TM...	10	8.20	73	19.5	20.2	3	13	8.5
	M12x1.5	1.5	HC10099L24-I1.50ISO TM...	10	9.90	73	24.0	24.7	4	16	10.5
	M14x1.5	1.5	HC12119L29-I1.50ISO TM...	12	11.90	80	28.5	29.2	4	19	12.5
	M16x1.5	1.5	HC14139L32-I1.50ISO TM...	14	13.90	92	31.5	32.2	4	21	14.5
M12x1.75		1.75	HC10099L25-I1.75ISO TM...	10	9.90	73	24.5	25.4	4	14	10.2
M14x2.0	M17-M80x2.0	2.0	HC12116L29-I2.00ISO TM...	12	11.60	80	28.0	29.0	4	14	12.0
M16x2.0	M17-M80x2.0	2.0	HC14136L33-I2.00ISO TM...	14	13.60	92	32.0	33.0	4	16	14.0
M18x2.5		2.5	HC16148L36-I2.50ISO TM...	16	14.80	92	35.0	36.2	4	14	15.5
M20x2.5		2.5	HC18171L41-I2.50ISO TM...	18	17.10	102	40.0	41.2	4	16	17.5
M24x3.0		3.0	HC20199L49-I3.00ISO TM...	20	19.90	102	48.0	49.5	4	16	21.0

Helicool

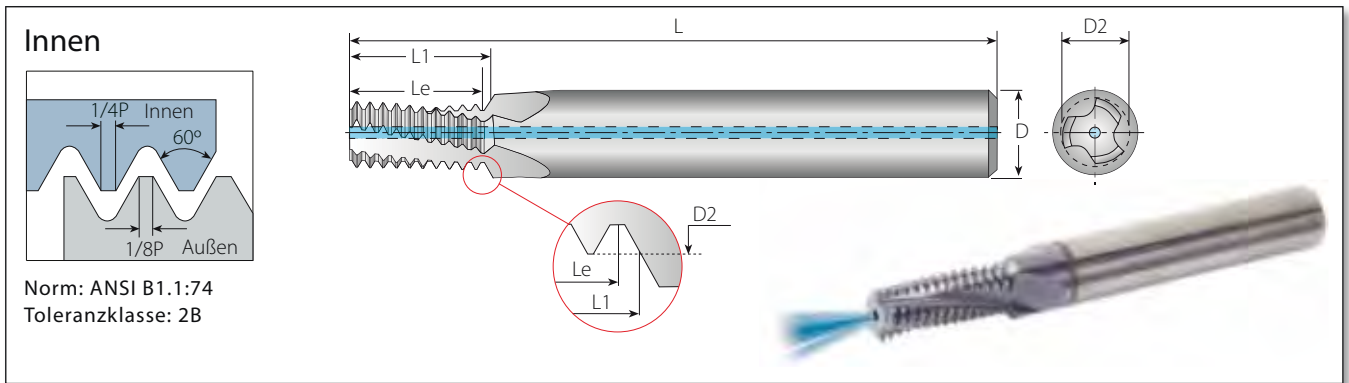

Norm: ANSI B1.1:74
Toleranzklasse: 2B

Gedrahte Werkzeuge mit innerer Kühlmittelzufuhr

1.5 x Do (L1 ≤ 1.5 x Gewindedurchmesser)

Gewinde			Teilung	Bestellnummer	Abmessungen mm					Zähnezahl	Zähne	Bohrungs Ø
UNC	UNF	UNEF	G/Z	Innen	D	D2	L	Le	L1	Z	Zt	mm
No.10-24	5/16", 3/8"x24	9/16"-11/16"x24	24	HC04035L07-I24UNC TM...	4	3.58	45	7.4	7.9	3	7	3.8
No.12-24	5/16", 3/8"x24	9/16"-11/16"x24	24	HC06041L08-I24UNC TM...	6	4.15	57	8.5	9.0	3	8	4.5
1/4"x20	7/16", 1/2"x20	3/4"-1"x20	20	HC06048L09-I20UNC TM...	6	4.88	57	8.9	9.5	3	7	5.2
5/16"x18	9/16", 5/8"x18	11/16"-1 1/16" x18	18	HC08061L11-I18UNC TM...	8	6.15	61	11.3	12.0	3	8	6.5
3/8"x16	3/4"x16		16	HC08076L15-I16UNC TM...	8	7.65	61	14.3	15.1	3	9	8.0
7/16"x14	7/8"x14		14	HC10090L17-I14UNC TM...	10	9.00	73	16.3	17.2	3	9	9.3
1/2"x13			13	HC12104L20-I13UNC TM...	12	10.35	73	19.5	20.5	4	10	10.8
9/16"x12	1"-1 1/2"x12		12	HC12118L22-I12UNC TM...	12	11.80	73	21.2	22.2	4	10	12.3

Gedrahte Werkzeuge mit innerer Kühlmittelzufuhr

2 x Do (L1 ≤ 2 x Gewindedurchmesser)

Gewinde			Teilung	Bestellnummer	Abmessungen mm					Zähnezahl	Zähne	Bohrungs Ø
UNC	UNF	UNEF	G/Z	Innen	D	D2	L	Le	L1	Z	Zt	mm
	No.10-32	No.12-3/8"x32	32	HC04038L09-I32UNF TM...	4	3.80	45	9.5	9.9	3	12	4.0
		No.12-3/8"x32	32	HC06044L11-I32UNEF TM...	6	4.40	57	11.1	11.5	3	14	4.7
	No.12, 1/4"x28	7/16", 1/2"x28	28	HC06043L11-I28UNF TM...	6	4.30	57	10.9	11.3	3	12	4.6
	1/4"x28	7/16", 1/2"x28	28	HC06052L13-I28UNF TM...	6	5.15	57	12.7	13.1	3	14	5.5
		7/16", 1/2"x28	28	HC10099L22-I28UNEF TM...	10	9.90	73	21.8	22.2	3	24	10.2
No.10-24	5/16", 3/8"x24	9/16"-11/16"x24	24	HC04035L10-I24UNC TM...	4	3.58	45	9.5	10.0	3	9	3.8
No.12-24	5/16", 3/8"x24	9/16"-11/16"x24	24	HC06041L11-I24UNC TM...	6	4.15	57	10.6	11.1	3	10	4.5
	5/16", 3/8"x24	9/16"-11/16"x24	24	HC08066L16-I24UNF TM...	8	6.68	61	15.9	16.4	3	15	6.8
	3/8"x24	9/16"-11/16"x24	24	HC10082L19-I24UNF TM...	10	8.20	73	19.0	19.6	3	18	8.5
		9/16"-11/16"x24	24	HC14129L29-I24UNEF TM...	14	12.90	92	28.6	29.1	4	27	13.2
1/4"x20	7/16", 1/2"x20	3/4"-1"x20	20	HC06048L13-I20UNC TM...	6	4.88	57	12.7	13.3	3	10	5.2
	7/16", 1/2"x20	3/4"-1"x20	20	HC10096L22-I20UNF TM...	10	9.60	73	21.6	22.2	3	17	9.8
	1/2"x20	3/4"-1"x20	20	HC12111L26-I20UNF TM...	12	11.10	80	25.4	26.0	4	20	11.5
		3/4"-1"x20	20	HC18174L38-I20UNEF TM...	18	17.40	102	38.1	38.7	4	30	17.8
5/16"x18	9/16", 5/8"x18	11/16"-1 1/16" x18	18	HC08061L16-I18UNC TM...	8	6.15	61	15.5	16.2	3	11	6.5
	9/16", 5/8"x18	11/16"-1 1/16" x18	18	HC14125L28-I18UNF TM...	14	12.50	92	28.2	28.9	4	20	12.8
	5/8"x18	11/16"-1 1/16" x18	18	HC16141L31-I18UNF TM...	16	14.10	92	31.0	31.7	4	22	14.5
3/8"x16	3/4"x16		16	HC08076L19-I16UNC TM...	8	7.65	61	19.0	19.8	3	12	8.0
	3/4"x16		16	HC18170L38-I16UNF TM...	18	17.00	102	38.1	38.8	4	24	17.5
7/16"x14	7/8"x14		14	HC10090L22-I14UNC TM...	10	9.00	73	21.8	22.7	3	12	9.3
	7/8"x14		14	HC20199L44-I14UNF TM...	20	19.90	102	43.5	44.4	4	24	20.5
1/2"x13			13	HC12104L26-I13UNC TM...	12	10.35	80	25.4	26.4	4	13	10.8
9/16"x12	1"-1 1/2"x12		12	HC12118L28-I12UNC TM...	12	11.80	80	27.5	28.6	4	13	12.3
	1"-1 1/2"x12		12	HC20199L51-I12UNF TM...	20	19.90	102	50.8	51.9	4	24	23.5
5/8"x11			11	HC14131L33-I11UNC TM...	14	13.10	92	32.3	33.5	4	14	13.5
3/4"x10			10	HC16159L39-I10UNC TM...	16	15.90	92	38.1	39.4	4	15	16.5
7/8"x9			9	HC20190L46-I9UNC TM...	20	19.00	102	45.2	46.6	4	16	19.5
1"x8			8	HC20199L52-I8UNC TM...	20	19.90	102	50.8	52.4	4	16	22.0

*Der Bohrungsdurchmesser bezieht sich auf den kleinsten Gewindenennendurchmesser

Maximale Gewindelänge = L1 - Teilung
4

Außen / Innen

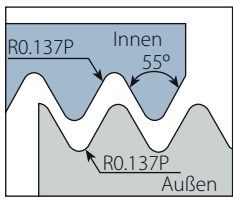

Norm: B.S.84:1956,
DIN 259, ISO228/1:1982
Toleranzklasse: Medium class A

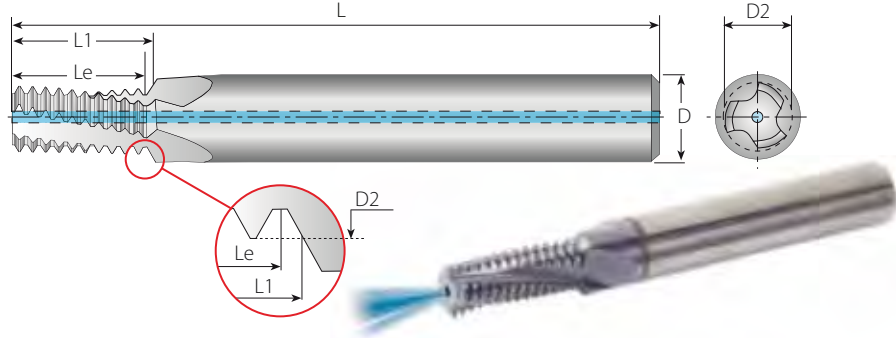

Gedrahte Werkzeuge mit innerer Kühlmittelzufuhr

2 x Do (L1 ≤ 2 x Gewindedurchmesser)

Gewinde		Teilung	Bestellnummer	Abmessungen mm				Zähnezahl	Zähne	Bohrungs Ø	
BSW	BSF	G/Z	Außen / Innen	D	D2	L	Le	L1	Z	Zt	mm
	1/4"x26	26	HC06050L13-EI26BSF TM...	6	5.00	57	12.7	13.2	3	13	5.3
	5/16"x22	22	HC08063L16-EI22BSF TM...	8	6.35	61	16.2	16.7	3	14	6.7
1/4"x20	3/8"x20	20	HC06044L13-EI20BSW TM...	6	4.45	57	12.7	13.3	3	10	5.0
	3/8"x20	20	HC08076L19-EI20BSF TM...	8	7.65	61	19.0	19.7	3	15	8.2
5/16"x18	7/16"x18	18	HC06058L16-EI18BSW TM...	6	5.85	57	15.5	16.2	3	11	6.5
	7/16"x18	18	HC10092L23-EI18BSF TM...	10	9.20	73	22.6	23.3	3	16	9.7
3/8"x16	1/2", 9/16"x16	16	HC08072L19-EI16BSW TM...	8	7.20	61	19.0	19.8	3	12	7.9
	1/2", 9/16"x16	16	HC12105L26-EI16BSF TM...	12	10.50	80	25.4	26.2	4	16	11.1
	9/16"x16	16	HC14122L29-EI16BSF TM...	14	12.15	92	28.6	29.4	4	18	12.6
7/16"x14	5/8", 11/16"x14	14	HC10085L22-EI14BSW TM...	10	8.50	73	21.8	22.7	3	12	9.2
	5/8", 11/16"x14	14	HC14134L31-EI14BSF TM...	14	13.40	92	30.8	31.7	4	17	14.0
	11/16"x14	14	HC16150L35-EI14BSF TM...	16	15.00	92	34.5	35.4	4	19	15.6
1/2"x12	3/4"x12	12	HC10096L26-EI12BSW TM...	10	9.65	73	25.4	26.5	3	12	10.5
9/16"x12	3/4"x12	12	HC12113L28-EI12BSW TM...	12	11.25	80	27.5	28.6	4	13	12.1
	3/4"x12	12	HC18162L39-EI12BSF TM...	18	16.20	102	38.1	39.2	4	18	16.8
5/8"x11	7/8"x11	11	HC14126L33-EI11BSW TM...	14	12.60	92	32.3	33.5	4	14	13.4
11/16"x11		11	HC16142L35-EI11BSW TM...	16	14.20	92	34.6	35.8	4	15	15.0

BSPT

Außen / Innen

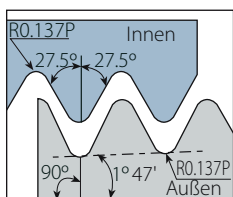

Norm: B.S.21:1985
Toleranzklasse: DIN EN 10226-1

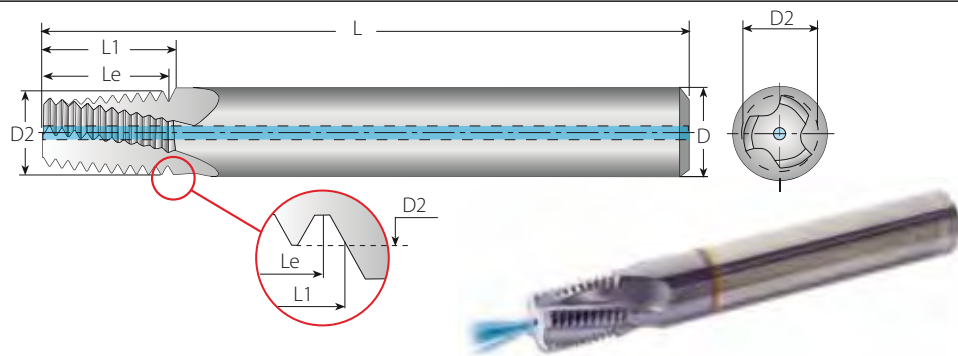

Gedrahte Werkzeuge mit innerer Kühlmittelzufuhr

Gewinde		Teilung	Bestellnummer	Abmessungen mm				Zähnezahl	Zähne	Bohrungs Ø
Standard	G/Z	Außen / Innen	D	D2	L	Le	L1	Z	Zt	mm
1/16"x28	28	HC06059L10-EI28BSPT TM...	6	5.90	57	10.0	10.2	3	11	6.7
1/8"x28	28	HC08076L10-EI28BSPT TM...	8	7.65	61	10.0	10.2	3	11	8.7
1/4"x19	19	HC10099L15-EI19BSPT TM...	10	9.90	73	14.7	15.4	3	11	11.8
3/8"x19	19	HC12111L15-EI19BSPT TM...	12	11.15	73	14.7	15.4	4	11	15.2
1/2", 3/4"x14	14	HC16142L22-EI14BSPT TM...	16	14.25	92	21.8	22.7	4	12	19.0
1", 1 1/2", 2", 2 1/2"x11	11	HC20196L28-EI11BSPT TM...	20	19.60	102	27.7	28.9	4	12	30.7

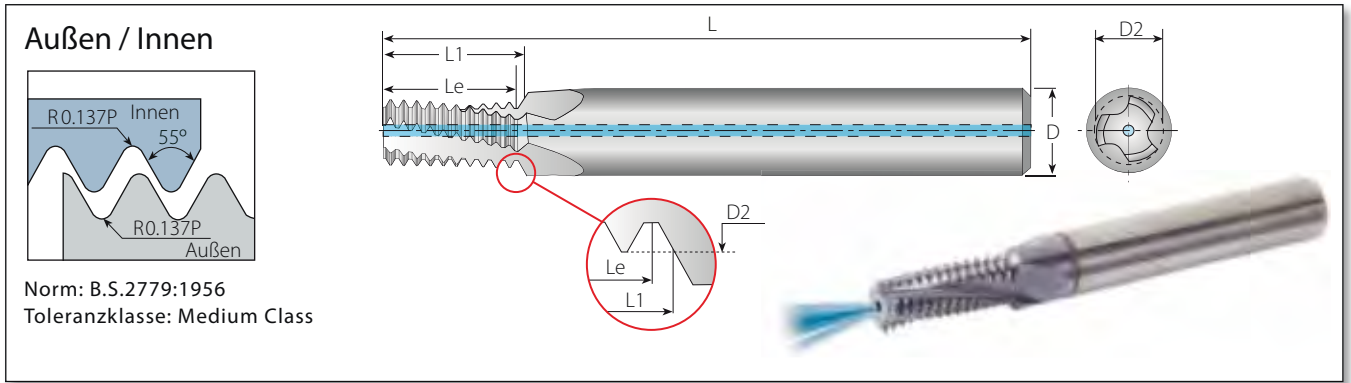

Gedrahte Werkzeuge mit innerer Kühlmittelzufuhr

1.5 x Do (L1 ≤ 1.5 x Gewindedurchmesser)

Gewinde	Teilung	Bestellnummer	Abmessungen mm					Zähnezahl	Zähne	Bohrungs Ø
Standard	G/Z	Außen / Innen	D	D2	L	Le	L1	Z	Zt	mm
1/16", 1/8"x28	28	HC08064L12-EI28BSP TM...	8	6.40	61	11.8	12.2	3	13	6.7
1/8"x28	28	HC10082L15-EI28BSP TM...	10	8.20	73	14.5	15.0	3	16	8.7
1/4", 3/8"x19	19	HC12110L20-EI19BSP TM...	12	11.00	80	20.0	20.7	4	15	11.8
3/8"x19	19	HC16145L26-EI19BSP TM...	16	14.50	92	25.4	26.1	4	19	15.2
1"-4"x11	11	HC20199L42-EI11BSP TM...	20	19.90	102	41.6	42.7	4	18	30.7

Gedrahte Werkzeuge mit innerer Kühlmittelzufuhr

2 x Do (L1 ≤ 2 x Gewindedurchmesser)

Gewinde	Teilung	Bestellnummer	Abmessungen mm					Zähnezahl	Zähne	Bohrungs Ø
Standard	G/Z	Außen / Innen	D	D2	L	Le	L1	Z	Zt	mm
1/16", 1/8"x28	28	HC08064L15-EI28BSP TM...	8	6.40	61	15.4	15.9	3	17	6.7
1/8"x28	28	HC10082L19-EI28BSP TM...	10	8.20	73	19.0	19.5	3	21	8.7
1/4", 3/8"x19	19	HC12110L27-EI19BSP TM...	12	11.00	80	26.7	27.4	4	20	11.8
3/8"x19	19	HC16145L34-EI19BSP TM...	16	14.50	92	33.4	34.1	4	25	15.2
1/2"-7/8"x14	14	HC18179L42-EI14BSP TM...	18	17.90	102	41.7	42.6	4	23	19.0

*Der Bohrungsdurchmesser bezieht sich auf den kleinsten Gewindenennendurchmesser

NPT

Helicool

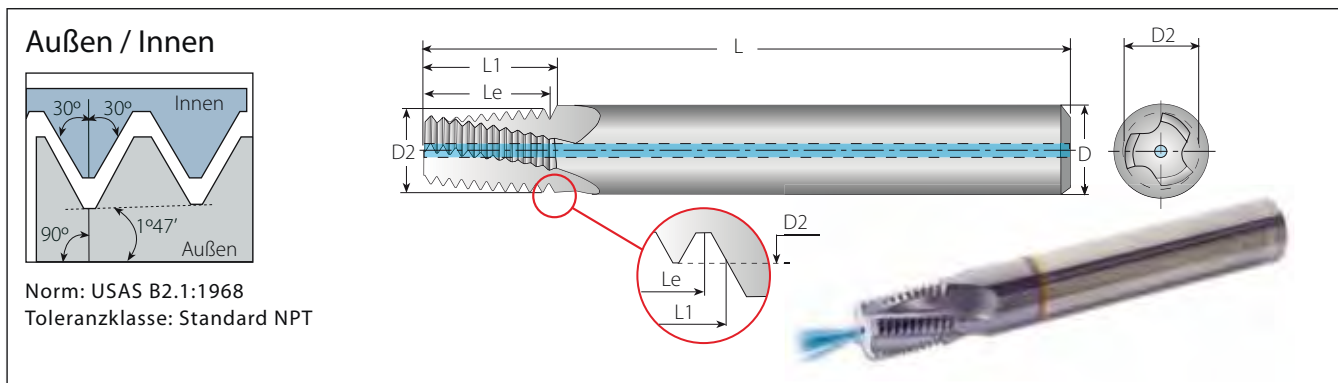

Gedrahte Werkzeuge mit innerer Kühlmittelzufuhr

Gewinde	Teilung	Bestellnummer	Abmessungen mm						Zähnezahl	Zähne	Bohrungs Ø
			Außen / Innen	D	D2	L	Le	L1			
Standard	G/Z										
1/16"x27	27	HC06059L09-EI27NPT TM...	6	5.90	57	9.4	9.9	3	10	6.3	
1/8"x27	27	HC08076L09-EI27NPT TM...	8	7.65	61	9.4	9.9	3	10	8.5	
1/4"x18	18	HC10099L14-EI18NPT TM...	10	9.90	73	14.1	14.8	3	10	11.1	
3/8"x18	18	HC12111L14-EI18NPT TM...	12	11.15	73	14.1	14.8	4	10	14.5	
1/2", 3/4"x14	14	HC16142L19-EI14NPT TM...	16	14.25	92	18.1	19.0	4	10	17.7, 23.0	
1", 1 1/4", 1 1/2", 2"x11.5	11.5	HC20196L23-EI11.5NPT TM...	20	19.60	102	22.1	23.2	4	10	29.0, 37.7, 44.0, 56.0	
2 1/2", 3"x8	8	HC20196L33-EI8NPT TM...	20	19.60	102	31.7	33.3	4	10	66.5, 82.1	

NPTF

Helicool

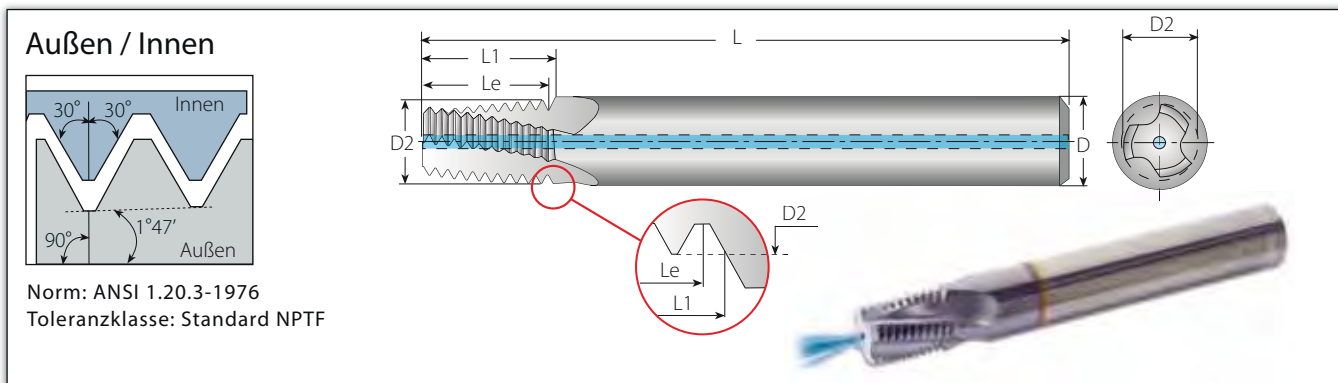

Gedrahte Werkzeuge mit innerer Kühlmittelzufuhr

Gewinde	Teilung	Bestellnummer	Abmessungen mm						Zähnezahl	Zähne	Bohrungs Ø
			Außen / Innen	D	D2	L	Le	L1			
Standard	G/Z										
1/16"x27	27	HC06059L09-EI27NPTF TM...	6	5.90	57	9.4	9.9	3	10	6.3	
1/8"x27	27	HC08076L09-EI27NPTF TM...	8	7.65	61	9.4	9.9	3	10	8.4	
1/4"x18	18	HC10099L14-EI18NPTF TM...	10	9.90	73	14.1	14.8	3	10	11.1	
3/8"x18	18	HC12111L14-EI18NPTF TM...	12	11.15	73	14.1	14.8	4	10	14.7	
1/2", 3/4"x14	14	HC16142L19-EI14NPTF TM...	16	14.25	92	18.1	19.0	4	10	17.9, 23.4	
1", 1 1/4", 1 1/2", 2"x11.5	11.5	HC20196L23-EI11.5NPTF TM...	20	19.60	102	22.1	23.2	4	10	29.0, 37.7, 43.7, 55.6	
2 1/2", 3"x8	8	HC20196L33-EI8NPTF TM...	20	19.60	102	31.7	33.3	4	10	66.3, 82.1	

ISO metrisch

Helicool-R (HCR)

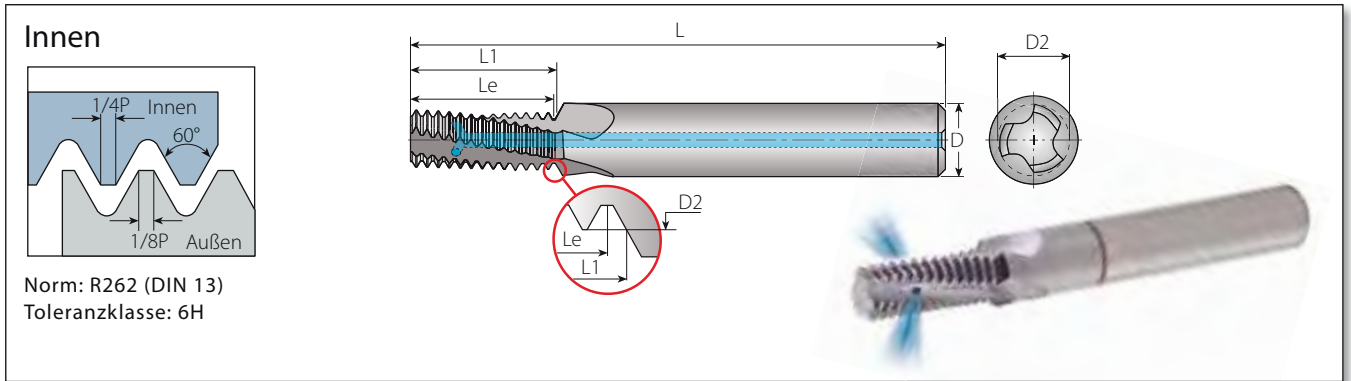

Norm: R262 (DIN 13)
Toleranzklasse: 6H

HeliCool-R (HCR)

Spiral genutet mit Radiale Kühlmittelzufuhr

2 x Do (L1 ≤ 2 x Gewindedurchmesser)

Gewinde		Teilung	Bestellnummer	Abmessungen (mm)					Anzahl Nuten	Zähne	Bohrungs Ø
M Regel	M Fein	mm	Innen	D	D2	L	Le	L1	Z	Zt	mm
M6x1.0	M8-M40x1.0	1.0	HCR06048L12-I1.00ISO TM...	6	4.8	57	12.0	12.5	3	12	5.0
	M10x1.0	1.0	HCR10087L20-I1.00ISO TM...	10	8.7	73	20.0	20.5	3	20	9.0
	M12x1.0	1.0	HCR12107L24-I1.00ISO TM...	12	10.7	73	24.0	24.5	4	24	11.0
M8x1.25		1.25	HCR08065L16-I1.25ISO TM...	8	6.5	64	16.3	16.9	3	13	6.8
M10x1.5	M12-M48x1.5	1.5	HCR10082L20-I1.50ISO TM...	10	8.2	73	19.5	20.3	3	13	8.5
	M12x1.5	1.5	HCR10099L24-I1.50ISO TM...	10	9.9	73	24.0	24.8	4	16	10.5
	M14x1.5	1.5	HCR12119L29-I1.50ISO TM...	12	11.9	84	28.5	29.3	4	19	12.5
	M16x1.5	1.5	HCR14139L32-I1.50ISO TM...	14	13.9	84	31.5	32.3	4	21	14.5
M12x1.75		1.75	HCR10099L25-I1.75ISO TM...	10	9.9	73	24.5	25.4	4	14	10.2

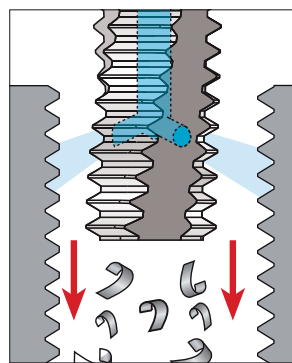

HeliCool-R für optimale Späneabfuhr bei Durchgangsbohrungen

*Der Bohrungsdurchmesser bezieht sich auf den kleinsten Gewindenennendurchmesser

Maximale Gewindelänge = $L1 - \frac{\text{Teilung}}{4}$

ISO metrisch

Helicool-C (HCC)

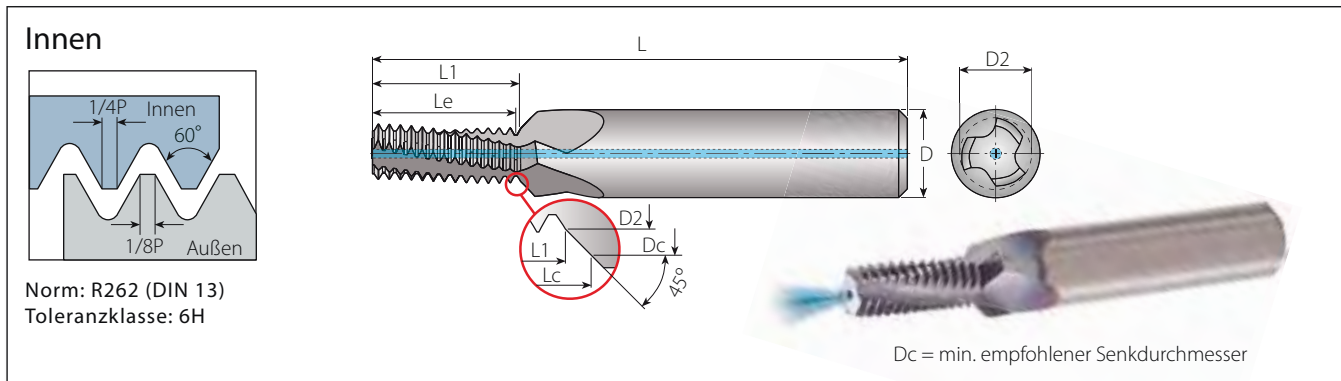

HeliCool-C (HCC)

Spiralgenutete Gewindefräser mit Senkfase und Kühlkanal

$2 \times D_o$ ($L1 \leq 2 \times \text{Gewindedurchmesser}$)

Gewinde		Teilung	Bestellnummer	Abmessungen (mm)								Zähnezahl	Zähne	Bohrungs Ø
M Regel	M Fein	mm	Innen	D	D2	Dc	L	Le	L1	Lc	Z	Zt	mm	
M6x1.0	M8-M40x1.0	1.0	HCC08048L12-I1.00ISO TM...	8	4.8	6.3	61	12.0	12.5	13.3	3	12	5.0	
	M10x1.0	1.0	HCC12087L20-I1.00ISO TM...	12	8.7	10.3	73	20.0	20.5	21.3	3	20	9.0	
	M12x1.0	1.0	HCC14107L24-I1.00ISO TM...	14	10.7	12.3	80	24.0	24.5	25.3	4	24	11.0	
M8x1.25		1.25	HCC10065L16-I1.25ISO TM...	10	6.5	8.3	73	16.3	16.9	17.8	3	13	6.8	
M10x1.5	M12-M48x1.5	1.5	HCC12082L20-I1.50ISO TM...	12	8.2	10.3	80	19.5	20.3	21.3	3	13	8.5	
	M12x1.5	1.5	HCC14099L24-I1.50ISO TM...	14	9.9	12.3	80	24.0	24.8	26.0	4	16	10.5	
	M14x1.5	1.5	HCC16119L29-I1.50ISO TM...	16	11.9	14.3	92	28.5	29.3	30.5	4	19	12.5	
	M16x1.5	1.5	HCC18139L32-I1.50ISO TM...	18	13.9	16.3	92	31.5	32.3	33.5	4	21	14.5	
M12x1.75		1.75	HCC14099L25-I1.75ISO TM...	14	9.9	12.3	80	24.5	25.4	26.6	4	14	10.2	

Helicool-C Arbeitsablauf

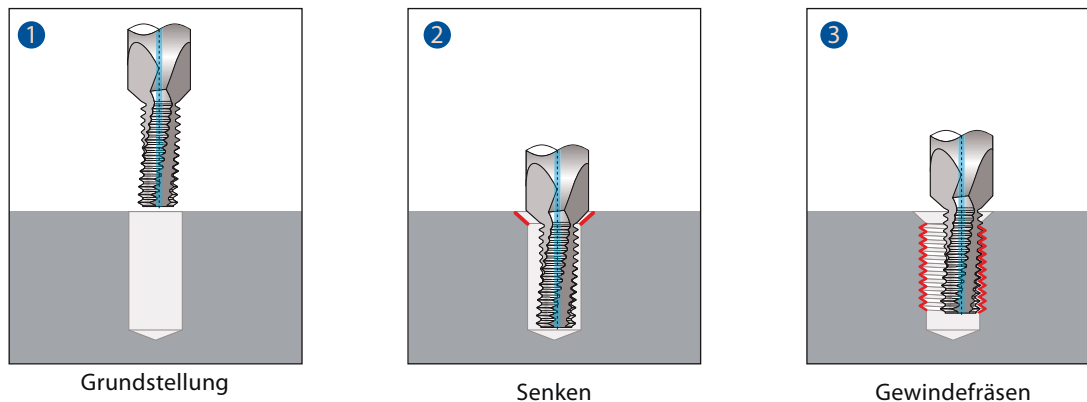

ISO metrisch

HTC - (Bohrgewindefräser)

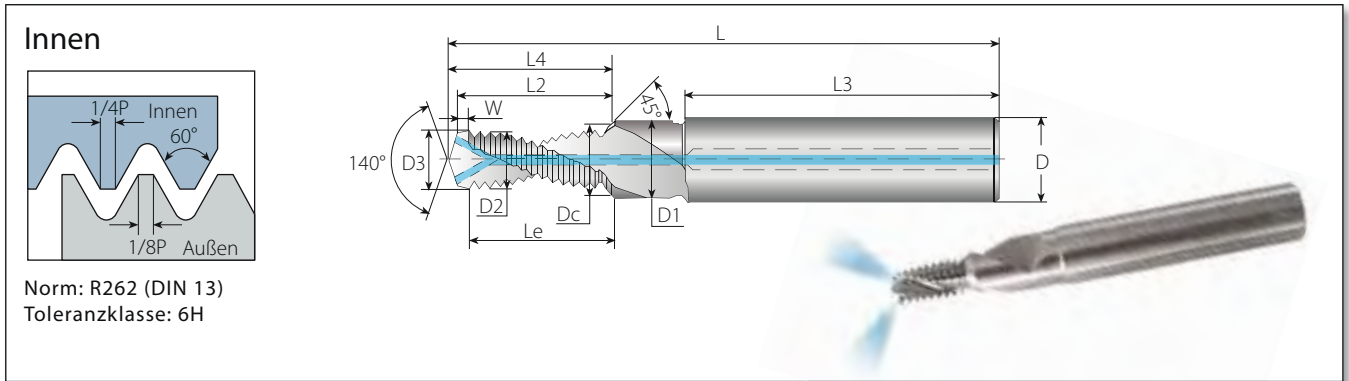

Norm: R262 (DIN 13)
Toleranzklasse: 6H

HTC - (Bohrgewindefräser)

Bohren, Gewinden und Fasen mit Kühlkanal

Gewinde	Bestellnummer	Teilung	Abmessungen											Zähnezahl	Zähne
			L	L4	L2	L3	W	Le	D3	D	D1	Dc	D2		
ISO 2xDo Coarse	Innen	mm	L	L4	L2	L3	W	Le	D3	D	D1	Dc	D2	Z	Zt
M6x1.0	HTC M6x1.0x2D...	1.00	62.0	14.5	13.7	36	1.0	12.7	5.0	8	6.6	6.3	4.85	2	11
M8x1.25	HTC M8x1.25x2D ...	1.25	74.0	18.2	17.1	40	1.3	15.8	6.8	10	9.0	8.3	6.45	2	11
M10x1.5	HTC M10x1.5x2D ...	1.50	79.0	23.4	22.1	45	1.5	20.6	8.5	12	11.0	10.3	8.08	2	12
M12x1.75	HTC M12x1.75x2D...	1.75	89.0	27.1	25.5	45	1.5	24.0	10.3	14	13.5	12.3	9.74	2	12
ISO 2.5xDo Coarse															
M6x1.0	HTC M6x1.0x2.5D ...	1.00	62.0	16.5	15.7	36	1.0	14.7	5.0	8	6.6	6.3	4.85	2	13
M8x1.25	HTC M8x1.25x2.5D...	1.25	74.0	23.2	22.1	40	1.3	20.8	6.8	10	9.0	8.3	6.45	2	15
M10x1.5	HTC M10x1.5x2.5D...	1.50	79.0	27.9	26.6	45	1.5	25.1	8.5	12	11.0	10.3	8.08	2	15

HTC - Bohrgewindefräser Arbeitsablauf

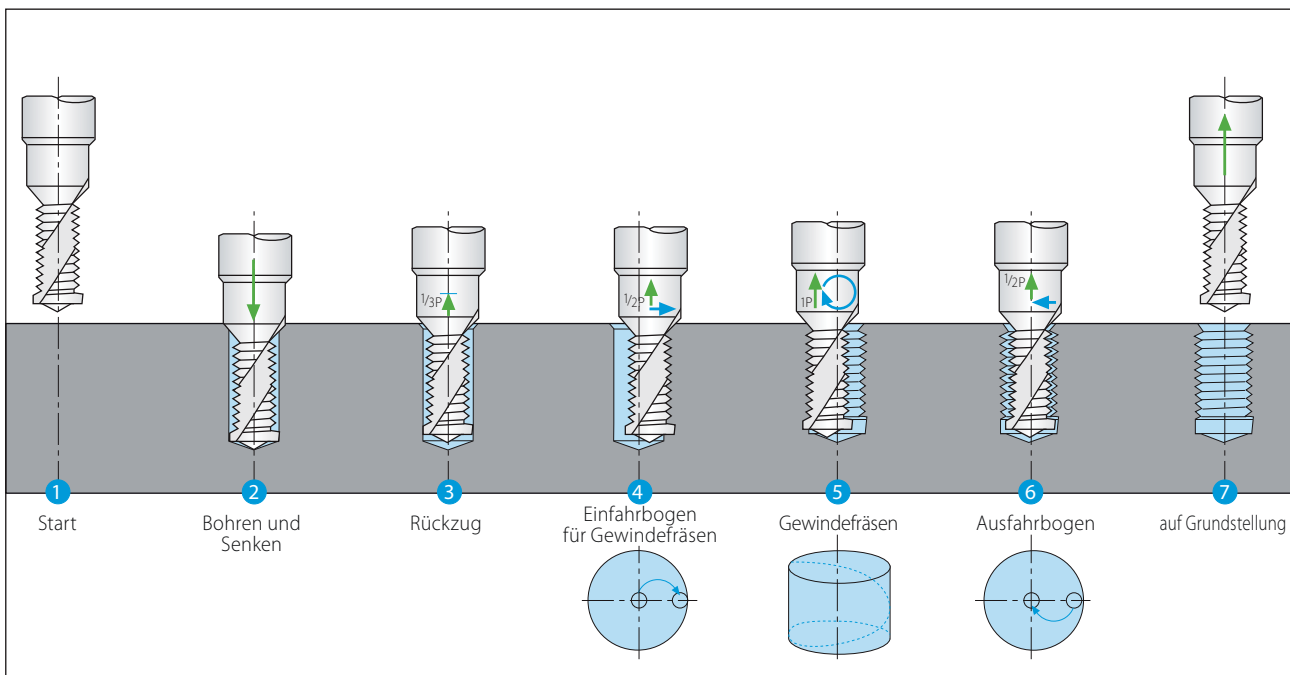

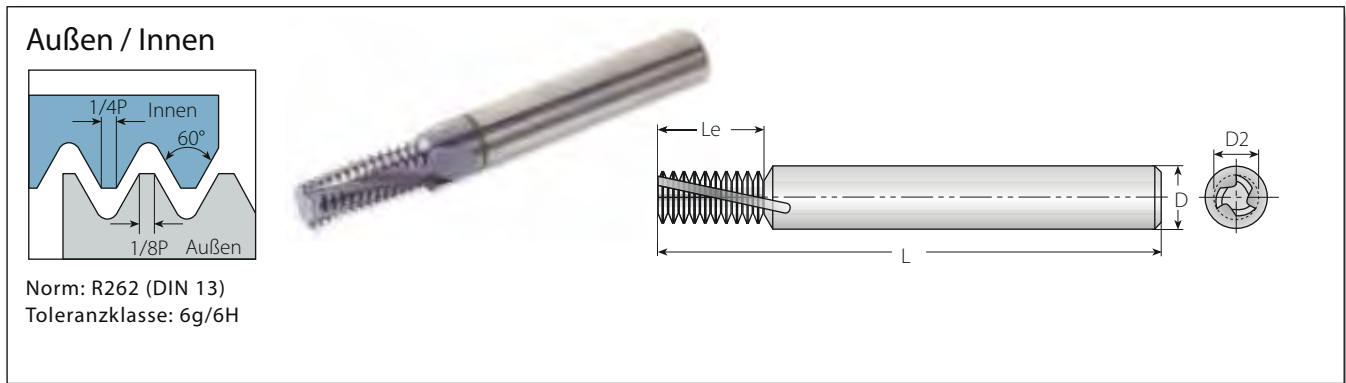

Spiral genutet - Aussen

2 x Do (L1 ≤ 2 x Gewindedurchmesser)

Gewinde	Teilung	Bestellnummer	Abmessungen mm				Zähnezahl	Zähne
M Regel	mm	Außen	D	D2	L	Le	Z	Zt
M3x0.5	0.5	H04039L06-E0.5ISO TM...	4	3.9	45	6.0	3	12
M4.5x0.75	0.75	H04039L09-E0.75ISO TM...	4	3.9	45	9.0	3	12
M6x1.0	1.0	H04039L12-E1.0ISO TM...	4	3.9	45	12.0	3	12
M8x1.25	1.25	H06059L16-E1.25ISO TM...	6	5.9	57	16.25	3	13
M10x1.5	1.5	H08079L21-E1.5ISO TM...	8	7.9	63	21.0	3	14
M14x2.0	2.0	H10099L28-E2.0ISO TM...	10	9.9	73	28.0	4	14

Spiral genutet - Innen

2 x Do (L1 ≤ 2 x Gewindedurchmesser)

Gewinde		Teilung	Bestellnummer	Abmessungen mm				Zähnezahl	Zähne	Bohrungs Ø
M Regel	M Fein	mm	Innen	D	D2	L	Le	Z	Zt	mm
M3x0.5	M3.5-M16x0.5	0.5	H04022L06-I0.5ISO TM...	4	2.2	45	6.0	3	12	2.5
	M4x0.5	0.5	H04030L08-I0.5ISO TM...	4	3.0	45	8.0	3	16	3.5
	M5x0.5	0.5	H04039L10-I0.5ISO TM...	4	3.9	45	10.0	3	20	4.5
M4x0.7		0.7	H04028L08-I0.7ISO TM...	4	2.8	45	8.4	3	12	3.3
	M6x0.75	0.75	H04039L12-I0.75ISO TM...	4	3.9	45	12.0	3	16	5.3
M5x0.8		0.8	H04035L10-I0.8ISO TM...	4	3.5	45	10.4	3	13	4.2
M6x1.0	M8-M40x1.0	1.0	H04039L12-I1.0ISO TM...	4	3.9	45	12.0	3	12	5.0
	M8x1.0	1.0	H06059L16-I1.0ISO TM...	6	5.9	57	16.0	3	16	7.0
	M10x1.0	1.0	H08079L20-I1.0ISO TM...	8	7.9	63	20.0	3	20	9.0
	M12x1.0	1.0	H10099L24-I1.0ISO TM...	10	9.9	73	24.0	4	24	11.0
M8x1.25		1.25	H06058L16-I1.25ISO TM...	6	5.8	57	16.25	3	13	6.8
	M10x1.25	1.25	H08077L20-I1.25ISO TM...	8	7.7	63	20.0	3	16	8.8
M10x1.5	M12-M48x1.5	1.5	H08077L21-I1.5ISO TM...	8	7.7	63	21.0	3	14	8.5
	M12x1.5	1.5	H10094L24-I1.5ISO TM...	10	9.4	73	24.0	4	16	10.5
	M14x1.5	1.5	H12112L28-I1.5ISO TM...	12	11.2	83	28.5	4	19	12.5
	M16x1.5	1.5	H12119L33-I1.5ISO TM...	12	11.9	83	33.0	4	22	14.5
M12x1.75		1.75	H10087L24-I1.75ISO TM...	10	8.7	73	24.5	4	14	10.2
M14x2.0	M17-M80x2.0	2.0	H10099L28-I2.0ISO TM...	10	9.9	73	28.0	4	14	12.0
	M16x2.0	2.0	H12119L32-I2.0ISO TM...	12	11.9	83	32.0	4	16	14.0
M18-M22x2.5		2.5	H16139L40-I2.5ISO TM...	16	13.9	92	40.0	5	16	15.5
M24x3.0		3.0	H16159L42-I3.0ISO TM...	16	15.9	92	42.0	4	14	21.0

Außen / Innen

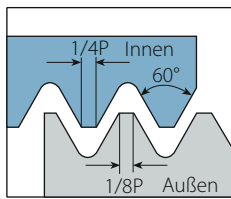

Norm: ANSI B1.10.74
Toleranzklasse: 2A/2B



Spiral genutet - Aussen

2 x Do (L1 ≤ 2 x Gewindedurchmesser)

Gewinde		Teilung	Bestellnummer	Abmessungen mm				Zähnezahl	Zähne
UNC	UNF	G/Z	Außen	D	D2	L	Le	Z	Zt
No.8-32		32	H04039L09-E32UNC TM...	4	3.9	45	8.7	3	11
	No.12-28	28	H04039L12-E28UNF TM...	4	3.9	45	11.8	3	13
No.12-24		24	H04039L12-E24UNC TM...	4	3.9	45	11.6	3	11
1/4"x20		20	H04039L13-E20UNC TM...	4	3.9	45	12.7	3	10
5/16"x18		18	H06059L17-E18UNC TM...	6	5.9	57	16.9	3	12
3/8"x16		16	H08079L19-E16UNC TM...	8	7.9	63	19.1	3	12
9/16"x12		12	H12119L30-E12UNC TM...	12	11.9	83	29.6	4	14

Helical Flutes - Internal

2 x Do (L1 ≤ 2 x Thread Diameter)

Gewinde			Teilung	Bestellnummer	Abmessungen mm				Zähnezahl	Zähne	Bohrungs Ø
UNC	UNF	UNEF	G/Z	Innen	D	D2	L	Le	Z	Zt	mm
No.8-36			36	H04030L09-I36UNF TM...	4	3.0	45	8.5	3	12	3.5
No.10-32		No.12-3/8"x32	32	H04033L11-I32UNF TM...	4	3.3	45	11.1	3	14	4.0
No.12-28,1/4"x28		7/16", 1/2"x28	28	H04038L12-I28UNF TM...	4	3.8	45	11.8	3	13	4.6
1/4"x28		7/16", 1/2"x28	28	H06046L13-I28UNF TM...	6	4.6	57	12.7	3	14	5.5
		7/16", 1/2"x28	28	H10092L23-I28UNEF TM...	10	9.2	73	22.7	4	25	10.2
No.10-24	5/16", 3/8"x24	9/16"-11/16"x24	24	H04029L11-I24UNC TM...	4	2.9	45	10.6	3	10	3.8
No.12-24	5/16", 3/8"x24	9/16"-11/16"x24	24	H04035L12-I24UNC TM...	4	3.5	45	11.6	3	11	4.5
	5/16", 3/8"x24	9/16"-11/16"x24	24	H06057L16-I24UNF TM...	6	5.7	57	15.9	3	15	6.8
	3/8"x24	9/16"-11/16"x24	24	H08074L19-I24UNF TM...	8	7.4	63	19.1	3	18	8.5
		9/16"-11/16"x24	24	H12119L29-I24UNEF TM...	12	11.9	83	28.6	4	27	13.2
1/4"x20	7/16", 1/2"x20	3/4"-1"x20	20	H04039L13-I20UNC TM...	4	3.9	45	12.7	3	10	5.2
	7/16", 1/2"x20	3/4"-1"x20	20	H10085L23-I20UNF TM...	10	8.5	73	22.9	4	18	9.8
	1/2"x20	3/4"-1"x20	20	H10099L26-I20UNF TM...	10	9.9	73	25.4	4	20	11.5
		3/4"-1"x20	20	H16159L38-I20UNEF TM...	16	15.9	92	38.1	5	30	17.8
5/16"x18	9/16", 5/8"x18	11/16"-1 1/16"x18	18	H06052L17-I18UNC TM...	6	5.2	57	16.9	3	12	6.5
	9/16", 5/8"x18	11/16"-1 1/16"x18	18	H12113L30-I18UNF TM...	12	11.3	83	29.6	4	21	12.8
	5/8"x18	11/16"-1 1/16"x18	18	H12119L33-I18UNF TM...	12	11.9	83	32.5	4	23	14.5
3/8"x16	3/4"x16		16	H08067L19-I16UNC TM...	8	6.7	63	19.1	3	12	8.0
	3/4"x16		16	H16159L38-I16UNF TM...	16	15.9	92	38.1	4	24	17.5
7/16"x14	7/8"x14		14	H08076L24-I14UNC TM...	8	7.6	63	23.6	4	13	9.3
	7/8"x14		14	H20187L44-I14UNF TM...	20	18.7	104	44.4	4	24	20.5
1/2"x13			13	H10089L26-I13UNC TM...	10	8.9	73	25.4	4	13	10.8
9/16"x12	1"-1 1/2"x12		12	H12103L30-I12UNC TM...	12	10.3	83	29.6	4	14	12.3
	1"-1 1/2"x12		12	H20199L51-I12UNF TM...	20	19.9	104	50.8	5	24	23.5
5/8"x11			11	H12110L32-I11UNC TM...	12	11.0	83	32.3	4	14	13.5
3/4"x10			10	H16135L38-I10UNC TM...	16	13.5	92	38.1	5	15	16.5
7/8"x9			9	H16152L45-I9UNC TM...	16	15.2	92	45.2	4	16	19.5
1"x8			8	H20170L51-I8UNC TM...	20	17.0	104	50.8	4	16	22.0

*Der Bohrungsdurchmesser bezieht sich auf den kleinsten Gewindenennendurchmesser

BSP(G)

Spiralgenutet

Außen / Innen

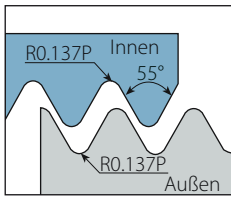

Norm: B.S.2779:1956
Toleranzklasse: Medium Class



Spiral genutet

$2 \times D_o$ ($L_1 \leq 2 \times \text{Gewindedurchmesser}$)

Gewinde	Teilung	Bestellnummer	Abmessungen mm				Zähnezahl	Zähne	Bohrungs Ø
Standard	G/Z	Außen / Innen	D	D2	L	Le	Z	Zt	mm
1/16"x28, 1/8"x28	28	H06058L16-EI28BSP TM...	6	5.8	57	16.3	3	18	6.7
1/8"x28	28	H08077L20-EI28BSP TM...	8	7.7	63	20.0	3	22	8.7
1/4"x19, 3/8"x19	19	H10099L27-EI19BSP TM...	10	9.9	73	26.7	4	20	11.8
3/8"x19	19	H16134L33-EI19BSP TM...	16	13.4	92	33.4	4	25	15.2
1/2", 3/4"x14	14	H16157L44-EI14BSP TM...	16	15.7	92	43.5	5	24	19.0
1", 1 1/2", 2", 2 1/2"x11	11	H20199L42-EI11BSP TM...	20	19.9	104	41.6	5	18	30.7

BSPT

Spiralgenutet

Außen / Innen

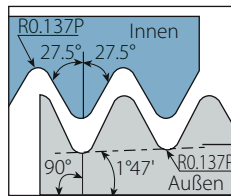

Norm: B.S.21:1985
Toleranzklasse: DIN EN 10226-1

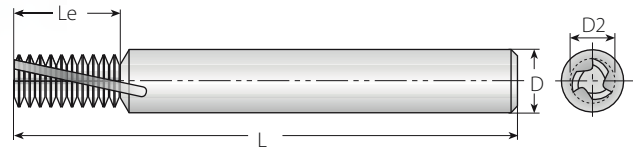

Spiral genutet

Gewinde	Teilung	Bestellnummer	Abmessungen mm				Zähnezahl	Zähne	Bohrungs Ø
Standard	G/Z	Außen / Innen	D	D2	L	Le	Z	Zt	mm
1/16"x28	28	H06058L16-EI28BSPT TM...	6	5.8	57	16.3	3	18	6.7
1/8"x28	28	H08077L20-EI28BSPT TM...	8	7.7	63	20.0	3	22	8.7
1/4"x19	19	H10099L27-EI19BSPT TM...	10	9.9	73	26.7	4	20	11.8
3/8"x19	19	H16134L33-EI19BSPT TM...	16	13.4	92	33.4	4	25	15.2
1/2", 3/4"x14	14	H16157L44-EI14BSPT TM...	16	15.7	92	43.5	5	24	19.0
1", 1 1/2", 2", 2 1/2"x11	11	H20199L42-EI11BSPT TM...	20	19.9	104	41.6	5	18	30.7

NPT

Spiralgenutet

Außen / Innen

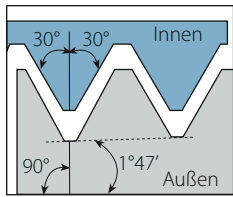

Norm: USAS B2.1:1968
Toleranzklasse: Standard NPT

Spiral genutet

Gewinde	Teilung	Bestellnummer	Abmessungen mm				Zähnezahl	Zähne	Bohrungs Ø
Standard	G/Z	Außen / Innen	D	D2	L	Le	Z	Zt	mm
1/16"x27	27	H06053L09-EI27NPT TM...	6	5.3	57	9.4	3	10	6.3
1/8"x27	27	H08075L09-EI27NPT TM...	8	7.5	63	9.4	4	10	8.5
1/4"x18	18	H10094L14-EI18NPT TM...	10	9.4	73	14.1	4	10	11.1
3/8"x18	18	H12119L14-EI18NPT TM...	12	11.9	83	14.1	4	10	14.5
1/2", 3/4"x14	14	H16155L25-EI14NPT TM...	16	15.5	92	25.4	5	14	17.7, 23.0
1"-2"x11.5	11.5	H20199L33-EI11.5NPT TM...	20	19.9	104	33.1	5	15	29.0-56.0
2 1/2", 3"x8	8	H20199L38-EI8NPT TM...	20	19.9	104	38.1	4	12	66.5

NPTF

Spiralgenutet

Außen / Innen

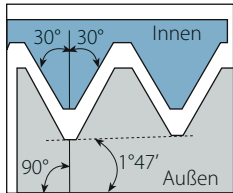

Norm: ANSI 1.20.3-1976
Toleranzklasse: Standard NPTF

Spiral genutet

Gewinde	Teilung	Bestellnummer	Abmessungen mm				Zähnezahl	Zähne	Bohrungs Ø
Standard	G/Z	Außen / Innen	D	D2	L	Le	Z	Zt	mm
1/16"x27	27	H06053L09-EI27NPTF TM...	6	5.3	57	9.4	3	10	6.3
1/8"x27	27	H08075L09-EI27NPTF TM...	8	7.5	63	9.4	4	10	8.4
1/4"x18	18	H10094L14-EI18NPTF TM...	10	9.4	73	14.1	4	10	11.1
3/8"x18	18	H12119L14-EI18NPTF TM...	12	11.9	83	14.1	4	10	14.7
1/2", 3/4"x14	14	H16155L25-EI14NPTF TM...	16	15.5	92	25.4	5	14	17.9, 23.4
1"-2"x11.5	11.5	H20199L33-EI11.5NPTF TM...	20	19.9	104	33.1	5	15	29.4-56.2
2 1/2", 3"x8	8	H20199L38-EI8NPTF TM...	20	19.9	104	38.1	4	12	67.0

*Der Bohrungsdurchmesser bezieht sich auf den kleinsten Gewindenennendurchmesser

ISO metrisch

Tiefes Gewindefräsen

Innen

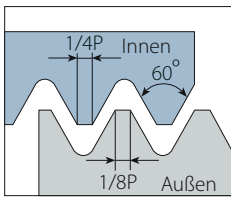

Norm: R262 (DIN 13)
Toleranzklasse: 6H

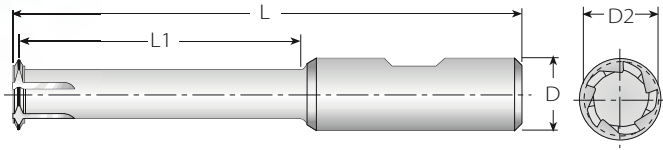

Tiefes Gewindefräsen - Lange Werkzeuge für tiefe Gewinde

3 x Do (L1 ≤ 3 x Gewindedurchmesser)

Gewinde	Teilung	Bestellnummer	Abmessungen mm				Zähnezahl	Zähne	Bohrungsdurchmesserbereich
			D	D2	L	L1			
M Regel	mm	Innen							mm
M6x1	1.0	D1T08041-I1.0ISO TM...	8	4.1	63	19	3	1	5.0
M8x1.25	1.25	D1T10058-I1.25ISO TM...	10	5.8	73	26	3	1	6.8
M10x1.5	1.50	D1T10077-I1.50ISO TM...	10	7.7	73	32	3	1	8.5
M12x1.5	1.50	D1T12094-I1.50ISO TM...	12	9.4	83	38	4	1	10.5
M12x1.75	1.75	D1T12087-I1.75ISO TM...	12	8.7	83	38	4	1	10.2
M14x2	2.0	D1T16102-I2.0ISO TM...	16	10.2	92	44	4	1	12.0
M16x2	2.0	D1T16122-I2.0ISO TM...	16	12.2	100	50	4	1	14.0
M18x2.5	2.50	D1T16129-I2.5ISO TM...	16	12.9	108	57	5	1	15.5
M20x2.5	2.50	D1T16148-I2.5ISO TM...	16	14.8	114	63	5	1	17.5

Teilprofil 60°

Tiefes Gewindefräsen

Innen

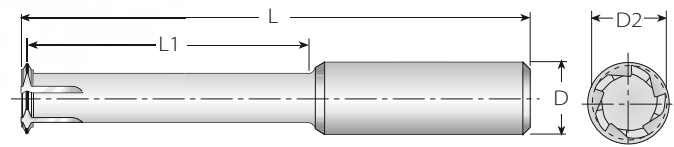
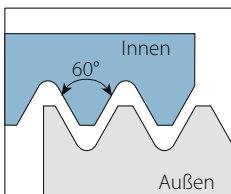

Tiefes Gewindefräsen - Lange Werkzeuge für tiefe Gewinde

Min. Gewinde		Teilung	Bestellnummer	Abmessungen							
M Regel	M Fein			UN, UNS, UNF, UNEF	mm	G/Z	Innen	D	D2	L	L1
M5x0.8	M5x0.5, M5x0.75	No.10-56UNS, No.10-48UNS, No.10-40UNS, No.10-36UNS, No.10-32UNF	0.5-0.8	32-56	D1T04390L160-ITA60 TM...	4	3.90	45	16	4	1
M6x1.0	M6x0.5, M6x0.75	No.12-56UNS, No.12-48UNS, 1/4-40UNS, 1/4-36UNS, 1/4-32UNEF, 1/4-28UNF, 1/4-27UNS, 1/4-24UNS	0.5-1.0	24-56	D1T06485L200-ITB60 TM...	6	4.85	51	20	5	1
M8x1.25	M7x0.5, M7x0.75, M7.5x1.0	5/16-48UNS, 5/16-40UNS, 5/16-36UNS, 5/16-32UNEF, 5/16-28UN, 5/16-27UNS, 5/16-24UNS, 5/16-20UN	0.5-1.25	20-48	D1T06590L250-ITF60 TM...	6	5.90	64	25	5	1
-	M10.5x0.5, M11x0.75, M11x1.0	7/16-32UN, 7/16-28UNEF, 7/16-27UNS, 7/16-24UNS	0.5-1.0	24-56	D1T10990L350-ITB60 TM...	10	9.90	73	35	6	1
M10x1.5	M10x1.0, M10x1.25	3/8-24UNF, 3/8-20UN, 7/16-18UNS, 7/16-16UN	1.0-1.50	16-24	D1T08790L320-ITC60 TM...	8	7.90	63	32	6	1
M12x1.75	M12x1.0, M12x1.25, M12x1.5	1/2-24UNS, 1/2-20UNS, 1/2-18UNS, 1/2-16UNS, 1/2-14UNS	1.0-1.75	14-24	D1T10990L380-ITD60 TM...	10	9.90	73	38	6	1
-	M13.5x1.0, M14x1.25, M14x1.5	9/16-24UNEF	1.0-1.75	14-24	D1T12119L450-ITD60 TM...	12	11.90	83	45	6	1

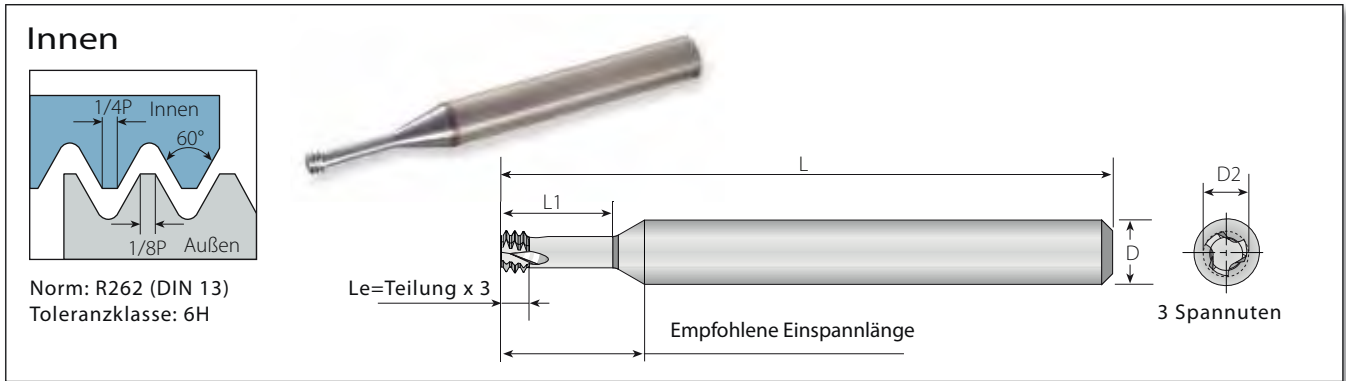

MilliPro

Minigewindefräser

2 x Do (L1 ≤ 2 x Gewindedurchmesser)

Gewinde		Teilung	Bestellnummer	Abmessungen mm				Zähnezahl	Zähne	Bohrungs Ø
M Regel	M Fein	mm	Innen	D	D2	L	L1	Z	Zt	mm
M1.6x0.35		0.35	D3T03012L034-I0.35ISO TM...	3	1.20	30	3.4	3	3	1.25
M2x0.4		0.4	D3T06015L042-I0.4ISO TM...	6	1.55	57	4.2	3	3	1.6
M2.2x0.45		0.45	D3T06016L046-I0.45ISO TM...	6	1.65	57	4.6	3	3	1.75
M2.5x0.45		0.45	D3T06019L052-I0.45ISO TM...	6	1.95	57	5.2	3	3	2.05
M3x0.5	M3.5-M16x0.5	0.5	D3T06024L062-I0.5ISO TM...	6	2.40	57	6.2	3	3	2.5
M3.5x0.6		0.6	D3T06027L073-I0.6ISO TM...	6	2.75	57	7.3	3	3	2.9
M4x0.7		0.7	D3T06031L083-I0.7ISO TM...	6	3.15	57	8.3	3	3	3.3
M5x0.8		0.8	D3T06040L104-I0.8ISO TM...	6	4.05	57	10.4	3	3	4.2
M6x1.0	M8-M40x1.0	1.0	D3T06048L125-I1.0ISO TM...	6	4.80	57	12.5	3	3	5.0
M8x1.25		1.25	D3T08065L166-I1.25ISO TM...	8	6.50	63	16.6	3	3	6.8
M10x1.5	M12-M48x1.50	1.50	D3T10082L208-I1.50ISO TM...	10	8.20	73	20.8	3	3	8.5
M12x1.75		1.75	D3T10099L250-I1.75ISO TM...	10	9.90	73	25.0	3	3	10.3
M16x2.0		2.0	D3T12119L330-I2.0ISO TM...	12	11.90	83	33.0	3	3	14.0
M20x2.5		2.50	D3T16159L413-I2.5ISO TM...	16	15.90	92	41.3	3	3	17.5

MilliPro

Minigewindefräser

3 x Do (L1 ≤ 3 x Gewindedurchmesser)

Gewinde		Teilung	Bestellnummer	Abmessungen mm				Zähnezahl	Zähne	Bohrungs Ø
M Regel	M Fein	mm	Innen	D	D2	L	L1	Z	Zt	mm
M1.6x0.35		0.35	D3T03012L050-I0.35ISO TM...	3	1.20	30	5.0	3	3	1.25
M2x0.4		0.4	D3T03015L062-I0.4ISO TM...	3	1.55	30	6.2	3	3	1.6
M2x0.4		0.4	D3T06015L062-I0.4ISO TM...	6	1.55	57	6.2	3	3	1.6
M2.5x0.45		0.45	D3T03019L077-I0.45ISO TM...	3	1.95	30	7.7	3	3	2.05
M2.5x0.45		0.45	D3T06019L077-I0.45ISO TM...	6	1.95	57	7.7	3	3	2.05
M3x0.5	M3.5-M16x0.5	0.5	D3T03024L092-I0.5ISO TM...	3	2.40	30	9.2	3	3	2.5
M3x0.5	M3.5-M16x0.5	0.5	D3T06024L092-I0.5ISO TM...	6	2.40	57	9.2	3	3	2.5
M4x0.7		0.7	D3T06031L123-I0.7ISO TM...	6	3.15	57	12.3	3	3	3.3
M5x0.8		0.8	D3T06040L154-I0.8ISO TM...	6	4.05	57	15.4	3	3	4.2
M6x1.0	M8-M40x1.0	1.00	D3T06048L185-I1.0ISO TM...	6	4.80	57	18.5	3	3	5.0
M8x1.25		1.25	D3T08065L246-I1.25ISO TM...	8	6.50	63	24.6	3	3	6.8

*Der Bohrungsdurchmesser bezieht sich auf den kleinsten Gewindenennendurchmesser

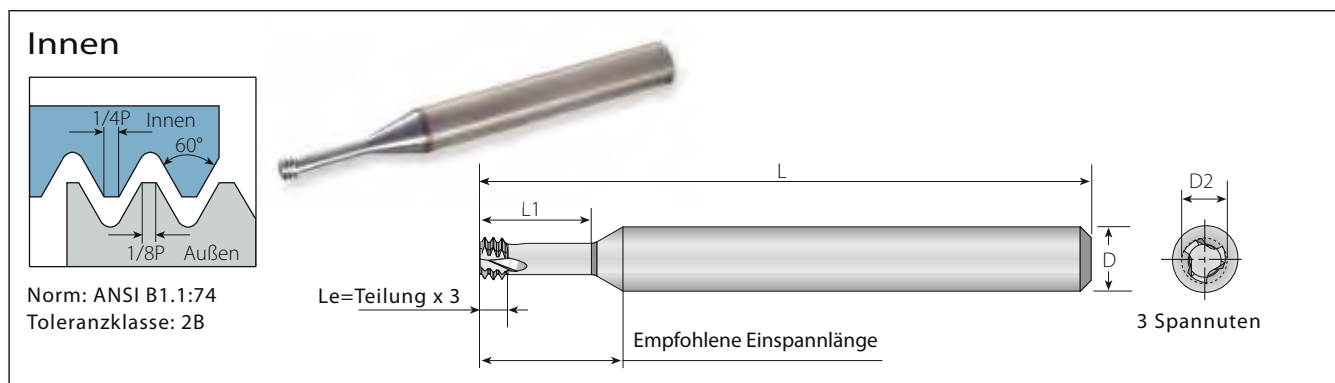

MilliPro

Minigewindefräser

2 x Do (L1 ≤ 2 x Gewindedurchmesser)

Gewinde		Teilung	Bestellnummer	Abmessungen mm				Zähnezahl	Zähne	Bohrungs Ø
UNC	UNF	G/Z	Innen	D	D2	L	L1	Z	Zt	mm
	No.1-72	72	D3T06014L039-I72UN TM...	6	1.45	57	3.9	3	3	1.6
No.1-64	No.2-64	64	D3T06014L042-I64UN TM...	6	1.40	57	4.2	3	3	1.5
No.2-56	No.3-56	56	D3T06016L050-I56UN TM...	6	1.65	57	5.0	3	3	1.8
No.3-48	No.4-48	48	D3T06019L060-I48UN TM...	6	1.90	57	6.0	3	3	2.1
No.4, No.5-40	No.6-40	40	D3T06021L060-I40UN TM...	6	2.10	57	6.0	3	3	2.3
No.5-40	No.6-40	40	D3T06024L072-I40UN TM...	6	2.45	57	7.2	3	3	2.6
	No.8-36	36	D3T06033L087-I36UN TM...	6	3.30	57	8.7	3	3	3.5
No.6, No.8-32	No.10-32	32	D3T06025L074-I32UN TM...	6	2.55	57	7.4	3	3	2.8
No.8-32	No.10-32	32	D3T06032L100-I32UN TM...	6	3.20	57	10.0	3	3	3.5
	1/4"x28	28	D3T06052L132-I28UN TM...	6	5.25	57	13.2	3	3	5.5
No.10-24	5/16"x24	24	D3T06035L102-I24UN TM...	6	3.58	57	10.2	3	3	3.9
	5/16"x24	24	D3T08066L165-I24UN TM...	8	6.68	63	16.5	3	3	6.9
1/4"x20	7/16"x20	20	D3T06048L134-I20UN TM...	6	4.88	57	13.4	3	3	5.2
	7/16"x20	20	D3T10095L230-I20UN TM...	10	9.55	73	23.0	3	3	9.9
3/8"x16		16	D3T08067L191-I16UN TM...	8	6.70	63	19.1	3	3	8.0
7/16"x14		14	D3T10090L233-I14UN TM...	10	9.00	73	23.3	3	3	9.4

MilliPro

Minigewindefräser

3 x Do (L1 ≤ 3 x Gewindedurchmesser)

Gewinde		Teilung	Bestellnummer	Abmessungen mm				Zähnezahl	Zähne	Bohrungs Ø
UNC	UNF	G/Z	Innen	D	D2	L	L1	Z	Zt	mm
	No.1-72	72	D3T03014L057-I72UN TM...	3	1.45	30	5.75	3	3	1.6
	No.1-72	72	D3T06014L057-I72UN TM...	6	1.45	57	5.75	3	3	1.6
No.2-56	No.3-56	56	D3T03016L070-I56UN TM...	3	1.65	30	7.0	3	3	1.8
No.4, No.5-40	No.6-40	40	D3T03021L090-I40UN TM...	3	2.10	30	9.0	3	3	2.3
No.4, No.5-40	No.6-40	40	D3T06021L090-I40UN TM...	6	2.10	57	9.0	3	3	2.3
No.5-40	No.6-40	40	D3T06024L100-I40UN TM...	6	2.45	57	10.0	3	3	2.6
No.6, No.8-32	No.10-32	32	D3T03025L110-I32UN TM...	3	2.55	30	11.0	3	3	2.8
No.6, No.8-32	No.10-32	32	D3T06025L110-I32UN TM...	6	2.55	57	11.0	3	3	2.8
No.8-32	No.10-32	32	D3T06032L130-I32UN TM...	6	3.20	57	13.0	3	3	3.4
	1/4"x28	28	D3T06052L196-I28UN TM...	6	5.25	57	19.6	3	3	5.5
	5/16"x24	24	D3T08066L245-I24UN TM...	8	6.68	63	24.5	3	3	6.9
1/4"x20	7/16"x20	20	D3T06048L198-I20UN TM...	6	4.88	57	19.8	3	3	5.1

Innen

5/16P Innen
60°
Rmax 0.18042P
Rmin 0.15011P Außen

Norm: ANSI B1.1:74
Toleranzklasse: 3B

Le=Teilung x 3

L

L1

D

D2

3 Spannuten

Empfohlene Einspannlänge

MilliPro - Minigewindefräser

3 x Do (L1 ≤ 3 x Gewindedurchmesser)

Gewinde		Teilung	Bestellnummer	Abmessungen mm				Zähnezahl	Zähne	Bohrungs Ø
UNJC	UNJF	G/Z	Innen	D	D2	L	L1	Z	Zt	mm
0.138" (#6)	0.190" (#10)	32	D3T06027L110-I32UNJ TM...	6	2.70	57	11.0	3	3	2.8
	0.250" (1/4")	28	D3T06054L195-I28UNJ TM...	6	5.40	57	19.5	3	3	5.6
0.190" (#10)		24	D3T06037L149-I24UNJ TM...	6	3.70	57	14.9	3	3	4.0
	0.3125" (5/16")	24	D3T08067L241-I24UNJ TM...	8	6.70	63	24.1	3	3	7.0
0.250" (1/4")		20	D3T06050L195-I20UNJ TM...	6	5.00	57	19.5	3	3	5.3
	0.4375" (7/16")	20	D3T10096L335-I20UNJ TM...	10	9.60	73	33.5	3	3	10.0
0.3125" (5/16")	0.5625" (9/16")	18	D3T08064L241-I18UNJ TM...	8	6.40	63	24.1	3	3	6.75
0.375" (3/8")	0.750" (3/4")	16	D3T08077L290-I16UNJ TM...	8	7.70	63	29.0	3	3	8.1
0.4375" (7/16")	0.875" (7/8")	14	D3T10092L335-I14UNJ TM...	10	9.20	73	33.5	3	3	9.5
0.500" (1/2")		13	D3T10099L385-I13UNJ TM...	10	9.90	73	38.5	3	3	11.0

Innen

1/4P Innen
60°
1/8P Außen

Norm: ISO 5855
Toleranzklasse: 4h/6h-4H/5H

Le=Teilung x 3

L

L1

D

D2

3 Spannuten

Empfohlene Einspannlänge

MilliPro - Minigewindefräser

3 x Do (L1 ≤ 3 x Gewindedurchmesser)

Gewinde	Teilung	Bestellnummer	Abmessungen mm				Zähnezahl	Zähne	Bohrungsdurchmesserbereich
Standard	mm	Innen	D	D2	L	L1	Z	Zt	mm
MJ3x0.5	0.5	D3T06024L092-I0.5MJ TM...	6	2.40	57	9.2	3	3	2.6
MJ3.5x0.6	0.6	D3T06028L110-I0.6MJ TM...	6	2.85	57	11.0	3	3	3.0
MJ4x0.7	0.7	D3T06031L123-I0.7MJ TM...	6	3.15	57	12.3	3	3	3.4
MJ5x0.8	0.8	D3T06040L154-I0.8MJ TM...	6	4.05	57	15.4	3	3	4.3
MJ6x1.0	1.0	D3T06048L185-I1.0MJ TM...	6	4.80	57	18.5	3	3	5.1
MJ8x1.25	1.25	D3T08065L246-I1.25MJ TM...	8	6.50	63	24.6	3	3	6.9
MJ10x1.5	1.50	D3T10082L308-I1.50MJ TM...	10	8.20	73	30.8	3	3	8.7
MJ12x1.75	1.75	D3T10099L370-I1.75MJ TM...	10	9.90	73	37.0	3	3	10.4
MJ14x2	2.0	D3T12119L425-I2.0MJ TM...	12	11.90	83	42.5	3	3	12.25

*Der Bohrungsdurchmesser bezieht sich auf den kleinsten Gewindenenddurchmesser

ISO metrisch

MilliPro Dental

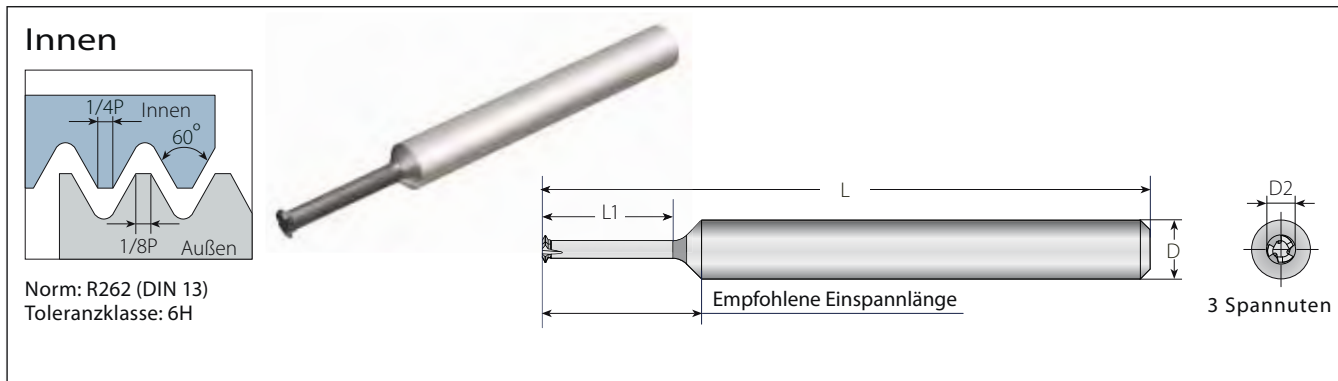

MilliPro Dental

Minigewindefräser für Medizinaltechnik

3xDo (L1 ≤ 3 x Gewindedurchmesser)

Gewinde	Teilung	Bestellnummer	Abmessungen mm				Zähnezahl	Zähne	Bohrungsdurchmesserbereich	
M Regel	M Fein	Innen	D	D2	L	L1	Z	Zt	mm	
M1.0x0.25	M1.4x0.25	0.25	D1T03007L031-I0.25ISO TM...	3	0.70	31	3.1	3	1	0.75
M1.2x0.25	M1.4x0.25	0.25	D1T03009L038-I0.25ISO TM...	3	0.90	31	3.8	3	1	0.95
M1.4x0.3		0.30	D1T03011L044-I0.30ISO TM...	3	1.05	31	4.4	3	1	1.15
M1.6x0.35		0.35	D1T03012L050-I0.35ISO TM...	3	1.20	31	5.0	3	1	1.30
M1.8x0.35	M2.0x0.35	0.35	D1T03014L056-I0.35ISO TM...	3	1.40	31	5.6	3	1	1.50
M2.0x0.4		0.40	D1T03015L062-I0.40ISO TM...	3	1.50	31	6.2	3	1	1.65
M2.5x0.45		0.45	D1T03019L077-I0.45ISO TM...	3	1.95	31	7.7	3	1	2.10

Amerikanisch UN

MilliPro Dental

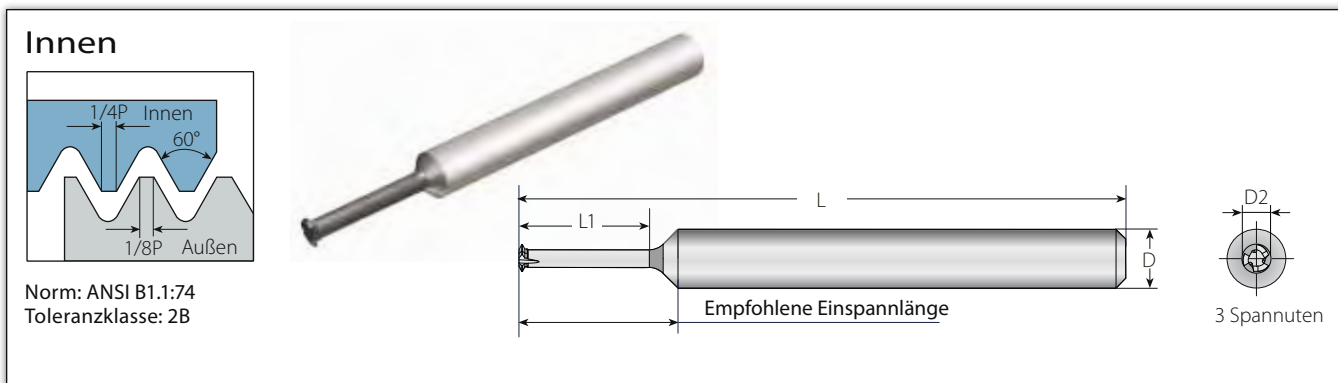

MilliPro Dental

Minigewindefräser für Medizinaltechnik

3xDo (L1 ≤ 3 x Gewindedurchmesser)

Gewinde	Teilung	Bestellnummer	Abmessungen mm				Zähnezahl	Zähne	Bohrungsdurchmesserbereich
UNF	G/Z	Innen	D	D2	L	L1	Z	Zt	mm
0-80	80	D1T03011L046-I80UN TM...	3	1.15	31	4.6	3	1	1.30
1-72	72	D1T03014L065-I72UN TM...	3	1.45	31	6.5	3	1	1.60

Das MilliPro Dental Programm speziell für die Verarbeitung von Titan und Edelstahl mit hohen Drehzahlen.

MilliPro Dental D1T Werkzeuge sind auch für allgemeine Anwendungen geeignet

ISO metrisch

MilliPro EL

Innen

Norm: R262 (DIN 13)
Toleranzklasse: 6H

Le=Teilung x 3

Empfohlene Einspannlänge

3 Spannuten

MilliPro EL

Minigewindefräser , extra lange Werkzeuge

2 x Do (L1 ≤ 2 x Gewindedurchmesser)

Gewinde		Teilung	Bestellnummer	Abmessungen mm				Zähnezahl	Zähne	Bohrungs Ø
M Regel	M Fein	mm	Innen	D	D2	L	L1	Z	Zt	mm
M2x0.4		0.4	D3T06015L042-10.4ISO TML...	6	1.55	100	4.2	3	3	1.6
M2.5x0.45		0.45	D3T06019L052-10.45ISO TML...	6	1.95	100	5.2	3	3	2.05
M3x0.5	M3.5-M16x0.5	0.5	D3T06024L062-10.5ISO TML...	6	2.40	100	6.2	3	3	2.5

Amerikanisch UN

MilliPro EL

Innen

Norm: ANSI B1.1:74
Toleranzklasse: 2B

Le=Teilung x 3

Empfohlene Einspannlänge

3 Spannuten

MilliPro EL

Minigewindefräser , extra lange Werkzeuge

2 x Do (L1 ≤ 2 x Gewindedurchmesser)

Gewinde		Teilung	Bestellnummer	Abmessungen mm				Zähnezahl	Zähne	Bohrungs Ø
UNC	UNF	G/Z	Innen	D	D2	L	L1	Z	Zt	mm
No.2-56	No.3-56	56	D3T06016L050-156UN TML...	6	1.65	100	5.0	3	3	1.8
No.4, No.5-40	No.6-40	40	D3T06021L060-140UN TML...	6	2.10	100	6.0	3	3	2.3
No.6, No.8-32	No.10-32	32	D3T06025L074-132UN TML...	6	2.55	100	7.4	3	3	2.8
No.8-32	No.10-32	32	D3T06032L100-132UN TML...	6	3.20	100	10.0	3	3	3.4

*Der Bohrungsdurchmesser bezieht sich auf den kleinsten Gewindenennendurchmesser

Innen

Norm: R262 (DIN 13)
Toleranzklasse: 6H

Empfohlene Einspannlänge

4-6 Spannuten

LH Werkzeug

MilliPro HD

Minigewindefräser für harte Materialien bis zu 62HRc

2 x Do (L1 ≤ 2 x Gewindedurchmesser)

Gewinde		Teilung	Bestellnummer	Abmessungen mm				Zähnezahl	Zähne	Bohrungs Ø
M Regel	M Fein	mm	Innen	D	D2	L	L1	Z	Zt	mm
M2x0.4		0.4	S2L06015L042-I0.4ISO TM...	6	1.55	76	4.60	4	2	1.6
M2.2x0.45		0.45	S2L06016L046-I0.45ISO TM...	6	1.65	76	5.05	4	2	1.8
M2.5x0.45		0.45	S2L06019L052-I0.45ISO TM...	6	1.95	76	5.65	4	2	2.05
M3x0.5	M3.5-M16x0.5	0.5	S2L06024L062-I0.5ISO TM...	6	2.40	76	6.75	4	2	2.55
M3.5x0.6		0.6	S2L06027L073-I0.6ISO TM...	6	2.75	76	7.90	4	2	2.95
M4x0.7		0.7	S2L06031L083-I0.7ISO TM...	6	3.15	76	9.05	4	2	3.35
M5x0.8		0.8	S2L06040L104-I0.8ISO TM...	6	4.05	76	11.20	4	2	4.3
M6x1.0	M8x-M40x1.0	1.0	S2L06048L125-I1.0ISO TM...	6	4.80	76	13.50	5	2	5.1
M8x1.25		1.25	S2L08065L166-I1.25ISO TM...	8	6.50	80	17.85	5	2	6.8
M10x1.5	M12-M48x1.50	1.50	S2L08079L208-I1.50ISO TM...	8	7.90	80	22.30	6	2	8.6
M12x1.75		1.75	S2L10099L250-I1.75ISO TM...	10	9.90	101	26.75	6	2	10.4

MilliPro HD

Minigewindefräser für harte Materialien bis zu 62HRc

3 x Do (L1 ≤ 3 x Gewindedurchmesser)

Gewinde		Teilung	Bestellnummer	Abmessungen mm				Zähnezahl	Zähne	Bohrungs Ø
M Regel	M Fein	mm	Innen	D	D2	L	L1	Z	Zt	mm
M2x0.4		0.4	S2L06015L062-I0.4ISO TM...	6	1.55	76	6.60	4	2	1.6
M2.5x0.45		0.45	S2L06019L077-I0.45ISO TM...	6	1.95	76	8.15	4	2	2.05
M3x0.5	M3.5-M16x0.5	0.5	S2L06024L092-I0.5ISO TM...	6	2.40	76	9.75	4	2	2.55
M4x0.7		0.7	S2L06031L123-I0.7ISO TM...	6	3.15	76	13.05	4	2	3.35
M5x0.8		0.8	S2L06040L154-I0.8ISO TM...	6	4.05	76	16.20	4	2	4.3
M6x1.0	M8-M40x1.0	1.0	S2L06048L185-I1.0ISO TM...	6	4.80	76	19.50	5	2	5.1
M8x1.25		1.25	S2L08065L246-I1.25ISO TM...	8	6.50	80	25.85	5	2	6.8

MilliPro-HD

2 Zähne: Vorschneider gefolgt vom zweiten Vollprofil-Zahn zum Fertigschneiden

Arbeitsrichtung vom Gewindeanfang zum Gewindegrund

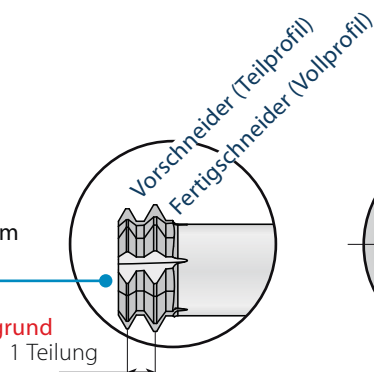

MilliPro HD sind linke Gewindefräser
CNC Programmierung M04

Innen

Norm: ANSI B1.1:74
Toleranzklasse: 2B

Empfohlene
Einspannlänge

4-6 Spannuten

LH Werkzeug

MilliPro HD

Minigewindefräser für harte Materialien bis zu 62HRC

2 x Do (L1 ≤ 2 x Gewindedurchmesser)

Gewinde		Teilung	Bestellnummer	Abmessungen mm			Zähnezahl	Zähne	Bohrungs Ø	
UNC	UNF	G/Z	Innen	D	D2	L	L1	Zt	mm	
No.2-56	No.3-56	56	S2L06016L050-I56UN TM...	6	1.65	76	5.45	4	2	1.80
No.3-48	No.4-48	48	S2L06019L060-I48UN TM...	6	1.90	76	6.53	4	2	2.10
No.4-40, No.5-40	No.6-40	40	S2L06021L060-I40UN TM...	6	2.10	76	6.64	4	2	2.35
No.5-40	No.6-40	40	S2L06024L072-I40UN TM...	6	2.45	76	7.84	4	2	2.65
	No.8-36	36	S2L06033L087-I36UN TM...	6	3.30	76	9.41	4	2	3.55
No.6-32, No.8-32	No.10-32	32	S2L06025L074-I32UN TM...	6	2.55	76	8.20	4	2	2.85
No.8-32	No.10-32	32	S2L06032L100-I32UN TM...	6	3.20	76	10.79	4	2	3.50
	No.10-32	32	S2L06037L100-I32UN TM...	6	3.70	76	10.80	4	2	4.17
	1/4"x28	28	S2L06052L132-I28UN TM...	6	5.25	76	14.11	5	2	5.55
No.10-24	5/16"x24	24	S2L06035L102-I24UN TM...	6	3.58	76	11.26	4	2	3.90
	5/16"x24	24	S2L08066L165-I24UN TM...	8	6.68	80	17.56	5	2	7.00
1/4"-20	7/16"x20	20	S2L06048L134-I20UN TM...	6	4.88	76	14.67	5	2	5.20
	7/16"x20	20	S2L10095L230-I20UN TM...	10	9.55	101	24.27	6	2	9.90
3/8"x16		16	S2L08076L197-I16UN TM...	8	7.65	80	21.29	5	2	8.00
7/16"x14		14	S2L10090L233-I14UN TM...	10	9.00	101	25.11	6	2	9.50
1/2"x13		13	S2L10099L256-I13UN TM...	10	9.90	101	27.55	6	2	10.90

MilliPro HD

Minigewindefräser für harte Materialien bis zu 62HRC

3 x Do (L1 ≤ 3 x Gewindedurchmesser)

Gewinde		Teilung	Bestellnummer	Abmessungen mm			Zähnezahl	Zähne	Bohrungs Ø	
UNC	UNF	G/Z	Innen	D	D2	L	L1	Zt	mm	
No.4-40, No.5-40	No.6-40	40	S2L06021L090-I40UN TM...	6	2.10	76	9.64	4	2	2.35
No.5-40	No.6-40	40	S2L06024L100-I40UN TM...	6	2.45	76	10.64	4	2	2.65
No.6-32, No.8-32	No.10-32	32	S2L06025L110-I32UN TM...	6	2.55	76	11.79	4	2	2.85
No.8-32	No.10-32	32	S2L06032L130-I32UN TM...	6	3.20	76	13.79	4	2	3.50
	1/4"x28	28	S2L06052L196-I28UN TM...	6	5.25	76	20.51	5	2	5.55
	5/16"x24	24	S2L08066L245-I24UN TM...	8	6.68	80	25.56	5	2	7.00
1/4"x20	7/16"x20	20	S2L06048L198-I20UN TM...	6	4.88	76	21.07	5	2	5.20
7/16"x14		14	S2L10090L335-I14UN TM...	10	9.00	101	35.31	6	2	9.50

Vorschneider
(Teilprofil)

Fertigschneider
(Vollprofil)

2 Zähne: Vorschneider gefolgt vom zweiten Vollprofil-Zahn zum Fertigschneiden

Arbeitsrichtung vom Gewindeanfang zum Gewindegrund

1 Teilung

MilliPro HD sind linke Gewindefräser CNC Programmierung M04

*Der Bohrungsdurchmesser bezieht sich auf den kleinsten Gewindenennendurchmesser

Außen / Innen

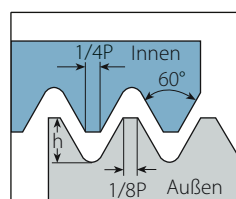

Norm: R262 (DIN 13)
Toleranzklasse: 6g/6H

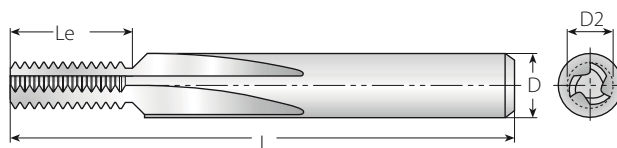

Gerade genutet - Aussen

Gewinde	Teilung	Bestellnummer	Abmessungen mm				Zähnezahl	Zähne	
Min. Ø	mm	Außen	D	D2	L	Le	Z	Zt	h mm
M3	0.50	S06059-E0.5ISO TM...	6	5.90	57	15.0	3	30	0.31
M4.5	0.75	S08079-E0.75ISO TM...	8	7.90	63	19.5	3, 5 *	26	0.46
M6	1.00	S10099-E1.0ISO TM...	10	9.90	72	24.0	5	24	0.61
M10	1.50	S12119-E1.5ISO TM...	12	11.90	83	30.0	5	20	0.92
M14	2.00	S12119-E2.0ISO TM...	12	11.90	83	30.0	5	15	1.23
M24	3.00	S16159-E3.0ISO TM...	16	15.90	92	36.0	5	12	1.84
M36	4.00	S16159-E4.0ISO TM...	16	15.90	92	40.0	5	10	2.45
M64	6.00	S20199-E6.0ISO TM...	20	19.90	104	36.0	5	6	3.68

Erhältlich mit 3 oder 5 Nuten. Fügen Sie bitte 3 oder 5 zur Bestellnummer hinzu (TM3.../TM5...)

Gerade genutet - Innen

Gewinde	Teilung	Bestellnummer	Abmessungen mm				Zähnezahl	Zähne	
Min. Ø	mm	Innen	D	D2	L	Le	Z	Zt	h mm
M4.5	0.75	S04030-I0.75ISO TM...	4	3.00	42	6.7	3	9	0.43
M8	0.75	S06059-I0.75ISO TM...	6	5.90	57	15.0	3	20	0.43
M5	0.80	S04036-I0.8ISO TM...	4	3.60	42	8.0	3	10	0.46
M6	1.00	S06040-I1.0ISO TM...	6	4.00	57	9.0	3	9	0.58
M12	1.00	S08079-I1.0ISOTM...	8	7.90	63	20.0	3, 5 *	20	0.58
M8	1.25	S06050-I1.25ISO TM...	6	5.00	57	12.5	3	10	0.72
M10	1.50	S06059-I1.5ISO TM...	6	5.90	57	15.0	3	10	0.87
M14	1.50	S10099-I1.5ISO TM...	10	9.90	72	24.0	5	16	0.87
M18	1.50	S12119-I1.5ISO TM...	12	11.90	83	30.0	5	20	0.87
M12	1.75	S08079-I1.75ISO TM...	8	7.90	63	19.2	3, 5 *	11	1.01
M16	2.00	S10099-I2.0ISO TM...	10	9.90	72	24.0	5	12	1.15
M18	2.00	S12119-I2.0ISO TM...	12	11.90	83	30.0	5	15	1.15
M20	2.50	S12119-I2.5ISO TM...	12	11.90	83	30.0	5	12	1.44
M24	3.00	S16159-I3.0ISO TM...	16	15.90	92	36.0	5	12	1.73
M30	3.50	S16159-I3.5ISO TM...	16	15.90	92	38.5	5	11	2.02
M36	4.00	S16159-I4.0ISO TM...	16	15.90	92	40.0	5	10	2.31
M48	5.00	S20199-I5.0ISO TM...	20	19.90	104	40.0	5	8	2.89
M64	6.00	S20199-I6.0ISO TM...	20	19.90	104	36.0	5	6	3.46

Erhältlich mit 3 oder 5 Nuten. Fügen Sie bitte 3 oder 5 zur Bestellnummer hinzu (TM3.../TM5...)

Außen / Innen

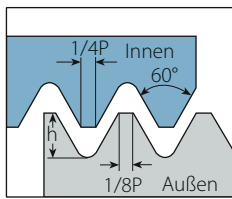

Norm: ANSI B1.1:74
Toleranzklasse: 2A/2B

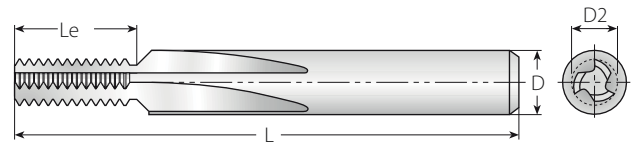

Gerade genutet - Aussen

Gewinde	Teilung	Bestellnummer	Abmessungen mm				Zähnezahl	Zähne	
Min. Ø	G/Z	Außen	D	D2	L	Le	Z	Zt	h mm
No.6	32	S06059-E32UN TM...	6	5.90	57	14.3	3	18	0.49
No.12	28	S08079-E28UN TM...	8	7.90	63	19.9	3,5 *	22	0.56
1/4"	20	S10099-E20UN TM...	10	9.90	72	22.9	5	18	0.78
5/16"	18	S10099-E18UN TM...	10	9.90	72	24.0	5	17	0.87
3/8"	16	S12119-E16UN TM...	12	11.90	83	28.6	5	18	0.97
9/16"	12	S12119-E12UN TM...	12	11.90	83	29.6	5	14	1.30
1"	8	S16159-E8UN TM...	16	15.90	92	38.1	5	12	1.95
1 3/8"	6	S20199-E6UN TM...	20	19.90	104	38.1	5	9	2.60

Erhältlich mit 3 oder 5 Nuten. Fügen Sie bitte 3 oder 5 zur Bestellnummer hinzu (TM3.../TM5...)

Gerade genutet - Innen

Gewinde	Teilung	Bestellnummer	Abmessungen mm				Zähnezahl	Zähne	
Min. Ø	G/Z	Innen	D	D2	L	Le	Z	Zt	h mm
No.8	36	S04030-I36UN TM...	4	3.00	42	6.3	3	9	0.41
No.8	32	S04030-I32UN TM...	4	3.00	42	6.3	3	8	0.46
5/16"	32	S06059-I32UN TM...	6	5.90	57	14.3	3	18	0.46
No.12	28	S04036-I28UN TM...	4	3.60	42	8.2	3	9	0.52
7/16"	28	S08079-I28UN TM...	8	7.90	63	19.9	3,5*	22	0.52
No.12	24	S06040-I24UN TM...	6	4.00	57	8.5	3	8	0.61
1/4"	20	S06040-I20UN TM...	6	4.00	57	10.2	3	8	0.73
9/16"	20	S10099-I20UN TM...	10	9.90	72	22.9	5	18	0.73
5/16"	18	S06050-I18UN TM...	6	5.00	57	12.7	3	9	0.81
9/16"	18	S10099-I18UN TM...	10	9.90	72	24.0	5	17	0.81
3/8"	16	S06059-I16UN TM...	6	5.90	57	14.3	3	9	0.92
3/4"	16	S12119-I16UN TM...	12	11.90	83	28.6	5	18	0.92
7/16"	14	S08079-I14UN TM...	8	7.90	63	18.1	3,5*	10	1.05
1/2"	13	S08079-I13UN TM...	8	7.90	63	19.5	3,5*	10	1.13
9/16"	12	S10099-I12UN TM...	10	9.90	72	23.3	5	11	1.22
1"	12	S12119-I12UN TM...	12	11.90	83	29.6	5	14	1.22
5/8"	11	S10099-I11UN TM...	10	9.90	72	23.1	5	10	1.33
3/4"	10	S12119-I10UN TM...	12	11.90	83	27.9	5	11	1.47
7/8"	9	S16159-I9UN TM...	16	15.90	92	33.3	5	12	1.63
1"	8	S16159-I8UN TM...	16	15.90	92	38.1	5	12	1.83
1 1/8"	7	S16159-I7UN TM...	16	15.90	92	36.3	5	10	2.09
1 3/8"	6	S20199-I6UN TM...	20	19.90	104	38.1	5	9	2.44
1 3/4"	5	S20199-I5UN TM...	20	19.90	104	40.6	5	8	2.93
2"	4.5	S20199-I4.5UN TM...	20	19.90	104	39.5	5	7	3.26

Erhältlich mit 3 oder 5 Nuten. Fügen Sie bitte 3 oder 5 zur Bestellnummer hinzu (TM3.../TM5...)

BSW

geradegemutet

Außen / Innen

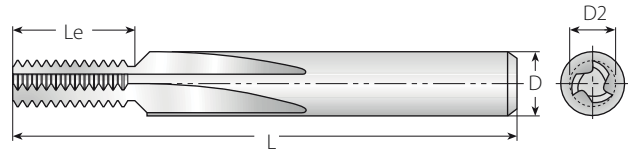
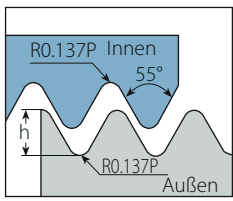

Norm: B.S.84:1956, DIN 259, ISO228/1:1982
Toleranzklasse: Medium class A

Gerade Spannuten

Gewinde	Teilung	Bestellnummer	Abmessungen mm				Zähnezahl	Zähne	
Min. Ø	G/Z	Außen / Innen	D	D2	L	Le	Z	Zt	h mm
1/4"	20	S06040-EI20BSW TM...	6	4.00	57	10.16	3	8	0.81
5/16"	18	S06050-EI18BSW TM...	6	5.00	57	11.29	3	8	0.90
3/8"	16	S06059-EI16BSW TM...	6	5.90	57	14.29	3	9	1.02
7/16"	14	S08079-EI14BSW TM...	8	7.90	63	18.14	3, 5*	10	1.16
1/2"	12	S08079-EI12BSW TM...	8	7.90	63	19.05	3, 5*	9	1.36
5/8"	11	S10099-EI11BSW TM...	10	9.90	72	23.09	5	10	1.48
3/4"	10	S12119-EI10BSW TM...	12	11.90	83	27.94	5	11	1.63
7/8"	9	S12119-EI9BSW TM...	12	11.90	83	28.22	5	10	1.81
1"	8	S16159-EI8BSW TM...	16	15.90	92	38.10	5	12	2.03
1 1/8"	7	S16159-EI7BSW TM...	16	15.90	92	36.29	5	10	2.32
1 3/8"	6	S16159-EI6BSW TM...	16	15.90	92	38.10	5	9	2.71
1 5/8"	5	S20199-EI5BSW TM...	20	19.90	104	40.64	5	8	3.25
1 7/8"	4.5	S20199-EI4.5BSW TM...	20	19.90	104	39.51	5	7	3.61

Erhältlich mit 3 oder 5 Nuten. Fügen Sie bitte 3 oder 5 zur Bestellnummer hinzu (TM3.../TM5...)

BSP

geradegemutet

Außen / Innen

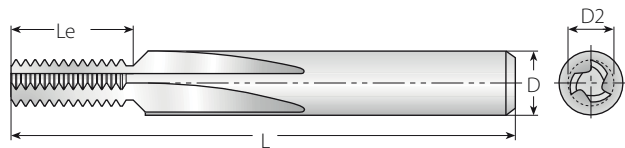
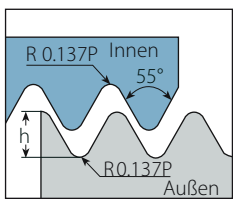

Norm: B.S.2779:1956
Toleranzklasse: Medium Class

Gerade Spannuten

Gewinde	Teilung	Bestellnummer	Abmessungen mm				Zähnezahl	Zähne	
Min. Ø	G/Z	Außen / Innen	D	D2	L	Le	Z	Zt	h mm
1/16"	28	S06059-EI28BSP TM...	6	5.90	57	14.51	3	16	0.58
1/4"	19	S08079-EI19BSP TM...	8	7.90	63	18.72	3, 5*	14	0.86
1/2"	14	S12119-EI14BSP TM...	12	11.90	83	29.03	5	16	1.16
1"	11	S16159-EI11BSP TM...	16	15.90	92	34.64	5	15	1.48

Erhältlich mit 3 oder 5 Nuten. Fügen Sie bitte 3 oder 5 zur Bestellnummer hinzu (TM3.../TM5...)

BSPT

geradegemutet

Außen / Innen

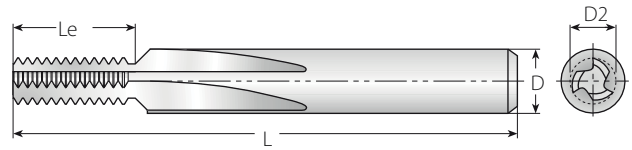
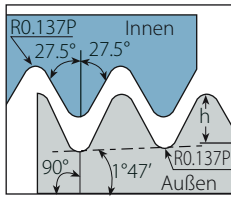

Norm: B.S.21:1985
Toleranzklasse: DIN EN 10226-1

Gerade Spannuten

Gewinde	Teilung	Bestellnummer	Abmessungen mm				Zähnezahl	Zähne	
Min. Ø	G/Z	Außen / Innen	D	D2	L	Le	Z	Zt	h mm
1/16"	28	S06059-EI28BSPT TM...	6	5.90	57	9.98	3	11	0.58
1/4"	19	S08079-EI19BSPT TM...	8	7.90	63	14.71	3, 5*	11	0.86
1/2"	14	S12119-EI14BSPT TM...	12	11.90	83	19.96	5	11	1.16
1"	11	S16159-EI11BSPT TM...	16	15.90	92	39.25	5	17	1.48

Erhältlich mit 3 oder 5 Nuten. Fügen Sie bitte 3 oder 5 zur Bestellnummer hinzu (TM3.../TM5...)

NPT

geradegemutet

Außen / Innen

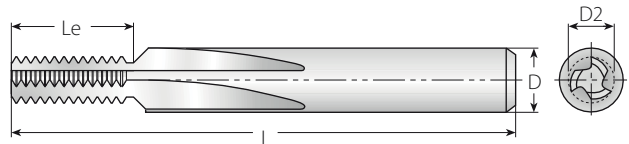
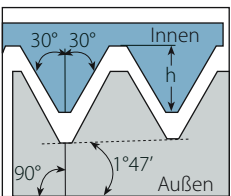

Norm: USAS B2.1:1968
Toleranzklasse: Standard NPT

Gerade Spannuten

Gewinde	Teilung	Bestellnummer	Abmessungen mm				Zähnezahl	Zähne	
Min. Ø	G/Z	Außen / Innen	D	D2	L	Le	Z	Zt	h mm
1/16"	27	S06059-EI27NPT TM...	6	5.90	57	9.41	3	10	0.66
1/4"	18	S08079-EI18NPT TM...	8	7.90	63	14.11	3, 5*	10	1.01
1/2"	14	S12119-EI14NPT TM...	12	11.90	83	19.96	5	11	1.33
1"	11.5	S16159-EI11.5NPT TM...	16	15.90	92	26.51	5	12	1.64
2 1/2"	8	S16159-EI8NPT TM...	16	15.90	92	38.10	5	12	2.42

Erhältlich mit 3 oder 5 Nuten. Fügen Sie bitte 3 oder 5 zur Bestellnummer hinzu (TM3.../TM5...)

geradegemutet

NPTF

geradegemutet

Außen / Innen

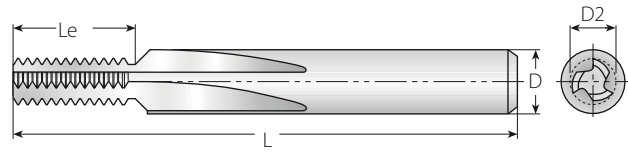
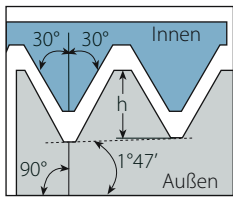

Norm: ANSI 1.20.3-1976
Toleranzklasse: Standard NPTF

Gerade Spannuten

Gewinde	Teilung	Bestellnummer	Abmessungen mm				Zähnezahl	Zähne	
Min. Ø	G/Z	Außen / Innen	D	D2	L	Le	Z	Zt	h mm
1/16"	27	S06059-EI27NPTF TM...	6	5.90	57	9.41	3	10	0.64
1/4"	18	S08079-EI18NPTF TM...	8	7.90	63	14.11	3, 5*	10	1.0
1/2"	14	S12119-EI14NPTF TM...	12	11.90	83	19.96	5	11	1.35
1"	11.5	S16159-EI11.5NPTF TM...	16	15.90	92	26.51	5	12	1.63
2 1/2"	8	S16159-EI8NPTF TM...	16	15.90	92	38.10	5	12	2.38

Erhältlich mit 3 oder 5 Nuten. Fügen Sie bitte 3 oder 5 zur Bestellnummer hinzu (TM3.../TM5...)

Pg

geradegemutet

Außen / Innen

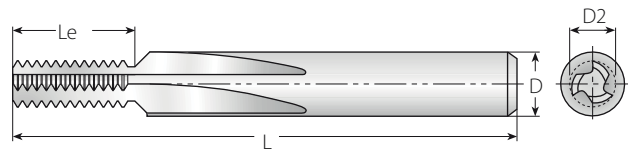
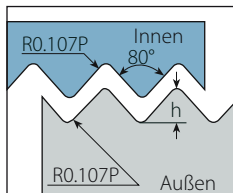

Norm: DIN 40430
Toleranzklasse: Standard

Gerade Spannuten

Gewinde	Teilung	Bestellnummer	Abmessungen mm				Zähnezahl	Zähne	
	G/Z	Außen / Innen	D	D2	L	Le	Z	Zt	h mm
Pg7	20	S08079-EI20PG TM...	8	7.90	63	19.05	3, 5*	15	0.61
Pg9, 11, 13.5, 16	18	S10099-EI18PG TM...	10	9.90	72	23.99	5	17	0.67
Pg21, 29, 36, 42, 48	16	S12119-EI16PG TM...	12	11.90	83	28.58	5	18	0.76

Erhältlich mit 3 oder 5 Nuten. Fügen Sie bitte 3 oder 5 zur Bestellnummer hinzu (TM3.../TM5...)

Sorten und ihre Anwendungen

VTH



- universelle Hochleistungsfräsorte
- TiCN beschichtet, mit hoher Verschleissfestigkeit.

VTS

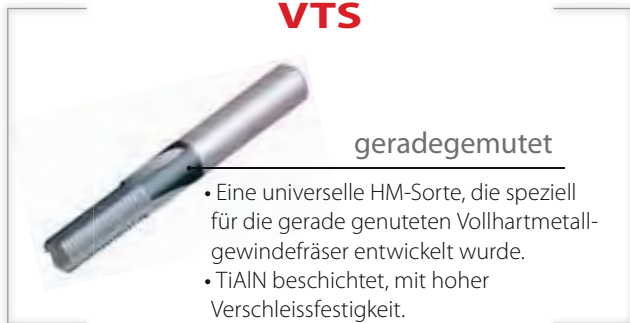

VTS



VTN



Downloads der TM Gen Software und Updates unter www.vargus.de

Schnittgeschwindigkeiten Vc [m/min] und Vorschübe fz [mm/Zahn]

Material- gruppe	Vardex Nr.	Material	Härte Brinell HB	Vc [m/min]			Vorschub [mm/Zahn]					
				Helicool, HCR, HCC, Spiral genutet, Sraight, Tiefes Gewindenfräsen		MilliPro	Spiralge- nutet	geradege- nutet	Tiefes Gewin- defräsen	Helicool HCC HCR	MilliPro	
				VTH	VTS	VTH						
P Stahl	1	Unlegierter Stahl	Geringer Kohlenstoffanteil (C=0.1-0.25%)	125	80-250	50-180	60-120	0.03-0.15	0.01-0.1	0.10-0.35	0.025-0.3	0.02-0.16
	2		Mittlerer Kohlenstoffanteil (C= 0.25- 0.55%)	150	80-230	50-140	60-120	0.03-0.1	0.01-0.08	0.08-0.30	0.02-0.26	0.02-0.16
	3		Hoher Kohlenstoffanteil (C= 0.55- 0.85%)	170	80-200	50-120	60-90	0.03-0.08	0.01-0.06	0.08-0.30	0.02-0.23	0.02-0.16
	4	Niedriglegierter Stahl (Legierungs- Elemente ≤ 5%)	Ungehärtet	180	60-180	60-170	60-90	0.03-0.1	0.03-0.07	0.08-0.30	0.02-0.22	0.015-0.16
	5		Gehärtet	275	60-170	60-160	50-80	0.03-0.07	0.03-0.07	0.08-0.30	0.01-0.15	0.015-0.07
	6		Gehärtet	350	60-160	60-150	50-80	0.01-0.03	0.005-0.01	0.05-0.15	0.01-0.1	0.015-0.03
	7	Hochlegierter Stahl (Legierungs- Elemente > 5%)	Vergütet	200	40-100	40-90	50-80	0.03-0.05	0.01-0.03	0.10-0.24	0.01-0.13	0.015-0.09
	8		Gehärtet	325	30-80	30-70	50-80	0.01-0.03	0.005-0.01	0.05-0.15	0.01-0.12	0.015-0.03
	9	Stahlguss	Niedriglegiert (Legierungs- Elemente < 5%)	200	80-250	70-200	70-90	0.03-0.1	0.01-0.03	0.08-0.30	0.01-0.15	0.015-0.16
	10		Hochlegiert (Legierungs- Elemente > 5%)	225	60-170	60-150	60-80	0.01-0.03	0.005-0.01	0.05-0.15	0.01-0.1	0.015-0.03
M Edelstahl	11	Edelstahl Ferritisch	Ungehärtet	200	60-150	50-140	60-90	0.04-0.1	0.01-0.05	0.11-0.35	0.01-0.13	0.015-0.16
	12		Gehärtet	330	60-120	50-110	50-80	0.01-0.05	0.005-0.01	0.05-0.24	0.01-0.12	0.015-0.03
	13	Edelstahl Austenitisch	Austenitisch	180	60-140	60-130	60-90	0.04-0.1	0.007-0.02	0.11-0.35	0.01-0.12	0.015-0.16
	14		Super- Austenitisch	200	60-130	50-120	50-80	0.04-0.1	0.007-0.02	0.11-0.35	0.01-0.1	0.015-0.16
	15	Edelstahl	Ungehärtet	200	60-160	50-150	60-90	0.04-0.1	0.01-0.03	0.11-0.35	0.01-0.15	0.015-0.16
	16		Gehärtet	330	60-110	50-100	50-80	0.03-0.05	0.005-0.01	0.10-0.24	0.01-0.1	0.015-0.03
	17	Edelstahl Guss austenitisch	Austenitisch	200	60-150	50-140	60-90	0.04-0.1	0.01-0.03	0.11-0.35	0.01-0.12	0.015-0.16
	18		Gehärtet	330	60-100	50-90	50-80	0.03-0.05	0.005-0.01	0.10-0.24	0.01-0.1	0.015-0.03
K Gußeisen	28	Temperguss	Ferritisch (kurzspanig)	130	60-70	60-150	50-80	0.01-0.03	0.007-0.02	0.05-0.15	0.01-0.15	0.015-0.03
	29		Perlitisch (langspanig)	230	60-150	80-100	60-90	0.03-0.05	0.005-0.01	0.10-0.24	0.01-0.12	0.02-0.12
	30	Grauguss	Niedrigfest	180	70-160	50-140	70-100	0.025-0.1	0.007-0.02	0.09-0.25	0.01-0.13	0.02-0.16
	31		Hochfest	260	40-120	40-110	60-90	0.03-0.05	0.005-0.01	0.10-0.24	0.01-0.12	0.02-0.12
	32	Kugelgraphitguss	Ferritisch	160	40-110	40-100	70-100	0.05-0.1	0.007-0.02	0.09-0.25	0.01-0.13	0.02-0.16
33	Perlitisch		260	40-100	40-90	60-90	0.03-0.05	0.005-0.01	0.10-0.24	0.01-0.12	0.02-0.12	
N(K) Nichteisen- Metalle	34	Aluminium- Legierungen Schmiedeeisen	ungealtert	60	200-300	150-250	60-250	0.1-0.25	0.05-0.15	0.12-0.40	0.04-0.4	0.025-0.15
	35		gealtert	100	150-250	100-220	60-150	0.1-0.2	0.03-0.1	0.10-0.32	0.03-0.36	0.025-0.16
	36	Aluminium- Legierungen	Guß	75	100-200	80-150	60-250	0.1-0.2	0.05-0.15	0.10-0.32	0.03-0.36	0.025-0.16
	37		Guß & gealtert	90	120-220	90-160	60-150	0.1-0.15	0.03-0.1	0.10-0.30	0.1-0.3	0.015-0.16
	38	Aluminium- Legierungen	Guß Si 13- 22%	130	200-300	150-250	250	0.1-0.2	0.05-0.15	0.10-0.32	0.03-0.36	0.03-0.15
	39	Kupfer und Kupferlegierungen	Messing	90	200-300	150-250	60-250	0.1-0.25	0.05-0.15	0.12-0.40	0.04-0.43	0.025-0.16
	40		Bronze und bleifreies Kupfer	100	150-250	100-220	60-150	0.1-0.2	0.03-0.1	0.10-0.32	0.03-0.36	0.03-0.15
S(M) Hitzebestän- dige Material	19	Hochtemperaturlegie- rungen	Vergütet (Eisen basiert)	200	30-60	30-50	60	0.04-0.1	0.007-0.02	0.11-0.35	0.007-0.09	0.015-0.16
	20		Gealtert (Eisen basiert)	280	20-50	20-40	50	0.01-0.03	0.005-0.01	0.05-0.15	0.006-0.07	0.015-0.03
	21		Vergütet (Nickel oder Cobalt basiert)	250	15-35	15-30	35	0.01-0.03	0.005-0.01	0.05-0.15	0.005-0.06	0.015-0.03
	22		Gealtert (Nickel oder Cobalt basiert)	350	15-30	15-25	30	0.01-0.03	0.005-0.01	0.05-0.15	0.005-0.06	0.015-0.03
	23	Titanlegierungen	Reines 99,5 Ti	400Rm	40-80	30-70	30-50	0.03-0.05	0.007-0.02	0.10-0.24	0.006-0.07	0.015-0.07
24	α+β Legierungen		1050Rm	20-50	20-45	25-35	0.03-0.05	0.007-0.02	0.10-0.24	0.006-0.07	0.015-0.07	
H(K) Gehärtetes Material	25	Extra harter Stahl	Gehärtet & angelassen	45- 50HRc	15-45	15-35	45	0.005- 0.01	0.003- 0.006	0.025- 0.06	0.004-0.04	0.01-0.04
	26			51- 55HRc	15-40	15-30	30	0.005- 0.01	0.003- 0.006	0.025- 0.06	0.004-0.04	-

* Empfehlung:

Beim Werkzeugeintritt den Vorschub um 70% niedriger ansetzen als den Gewindeschneidvorschub.

Beispiel:

Gewindeschneidvorschub: 0.3 [mm/Zahn]

Werkzeugeintrittvorschub: 0.09 [mm/Zahn]

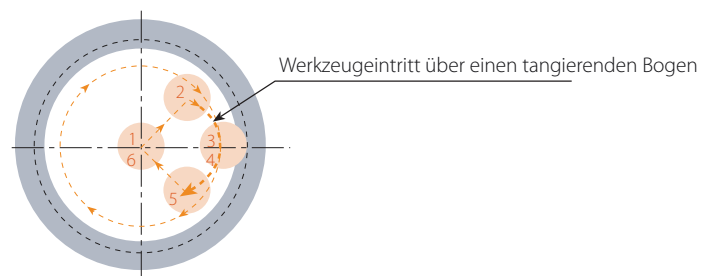

MilliPro HD Schnittgeschwindigkeiten Vc [m/min] und Vorschübe fz [mm/Zahn]

Materialgruppe	Vardex Nr.	Material	Härte Brinell HB	Vc [m/min]		Vorschub fz [mm/Zahn] bei Schneidendurchmesser=D2				
				VTH		1.5-2.5	2.5-5	5-7	7-9	9-11
P Stahl	6	Niedriglegierter Stahl (Legierungs- Elemente ≤ 5%)	Gehärtet	350	25-160	0.04	0.05	0.06	0.07	0.08
	8	Hochlegierter Stahl (Legierungs- Elemente > 5%)	Gehärtet	325	25-180					
M Edelstahl	12	Edelstahl Ferritisch	Gehärtet	330	25-120	0.04	0.05	0.06	0.07	0.08
	16	Edelstahl	Gehärtet	330	25-110					
	18	Edelstahl Guss austenitisch	Gehärtet	330	25-100					
K Gußeisen	28	Temperguss	Ferritisch (kurzspanig)	130	25-160	0.05	0.06	0.07	0.08	0.1
	29		Perlitisch (langspanig)	230	25-150	0.04	0.05	0.06	0.07	0.08
	30	Grauguss	Niedrigfest	180	25-130	0.05	0.06	0.07	0.08	0.1
	31		Hochfest	260	25-100	0.04	0.05	0.06	0.07	0.08
	32	Kugelgraphitguss	Ferritisch	160	25-125	0.04	0.05	0.06	0.07	0.09
	33		Perlitisch	260	25-90	0.03	0.04	0.05	0.06	0.07
S(M) Hitzebeständige Material	21	Hochtemperaturlegierungen	Vergütet (Nickel oder Cobalt basiert)	250	15-35	0.03	0.04	0.05	0.06	0.07
	22		Gealtert (Nickel oder Cobalt basiert)	350	15-30					
	23	Titanlegierungen	Reines 99,5 Ti	400Rm	25-70					
	24		α+β Legierungen	1050Rm	25-50					
H(K) Gehärtetes Material	25	Extra harter Stahl	Gehärtet & angelassen	45-50HRc	25-70	0.04	0.05	0.06	0.07	0.08
	26			51-55HRc	25-60	0.03	0.04	0.05	0.06	0.07
	27			56-62HRc	25-50	0.02	0.03	0.04	0.05	0.06

Empfohlene Sorten, Schnittgeschwindigkeit und Vorschübe für HTC

Materialgruppe	Material	Härte Brinell HB	Zugfestigkeit (N/mm ²)	Vc [m/min]		Vf [mm/U]		fz [mm/Zahn]		
				VTN	VTS	≤6mm	≤12mm	≤6mm	≤12mm	
K Gußeisen	Gußeisen	Grauguss	≤150	≤500	50-80	80-120	0.10-0.15	0.15-0.22	0.02-0.05	0.05-0.10
		Grauguss vergütet	150-300	500-1000	50-80	80-120	0.10-0.15	0.15-0.22	0.02-0.05	0.05-0.10
		Sphäroguss	≤200	≤700	50-80	80-120	0.10-0.15	0.15-0.22	0.02-0.05	0.05-0.10
	Kupfer	Kurzspanendes, Messing, Bronze, Rotguss	≤200	≤700	100-300	—	0.10-0.30	0.06-0.10	0.03-0.06	0.06-0.10
N(K) Nichteisen-Metalle	Aluminium/Magnesium	Aluminium, Magnesium unlegiert	≤100	≤350	100-400	100-400	0.10-0.25	0.25-0.30	0.03-0.06	0.06-0.10
		Aluminium Knetlegierung, Bruchdehnung (A5) < 14%	≤180	≤600	100-400	100-400	0.10-0.25	0.25-0.30	0.03-0.06	0.06-0.10
		Aluminium Knetlegierung, Bruchdehnung (A5) ≥ 14%	≤180	≤600	100-400	100-400	0.03-0.06	0.06-0.12	0.03-0.06	0.06-0.10
		Aluminium, Gusslegierung, Si<10%	≤180	≤600	100-300	100-400	0.10-0.25	0.25-0.30	0.03-0.06	0.06-0.10
		Aluminium, Gusslegierung, Si≥10%	≤180	≤600	—	100-300	0.10-0.25	0.25-0.30	0.03-0.06	0.06-0.10
K	Kunststoff	Thermoplaste	—	—	60-120	60-120	0.10-0.25	0.25-0.30	0.03-0.06	0.06-0.10
		Duroplaste	—	—	60-100	60-100	0.10-0.25	0.25-0.30	0.03-0.06	0.06-0.10
		Faserverstärkte Kunststoffe	—	—	40-60	60-80	0.10-0.15	0.15-0.22	0.02-0.05	0.05-0.10

Vc - Schnittgeschwindigkeit [m/Min.]

Vf (Bohren) - Vorschub pro Umdrehung [mm/U]

fz (Gewindefräsen) - Vorschub pro Zahn [mm/Zahn]

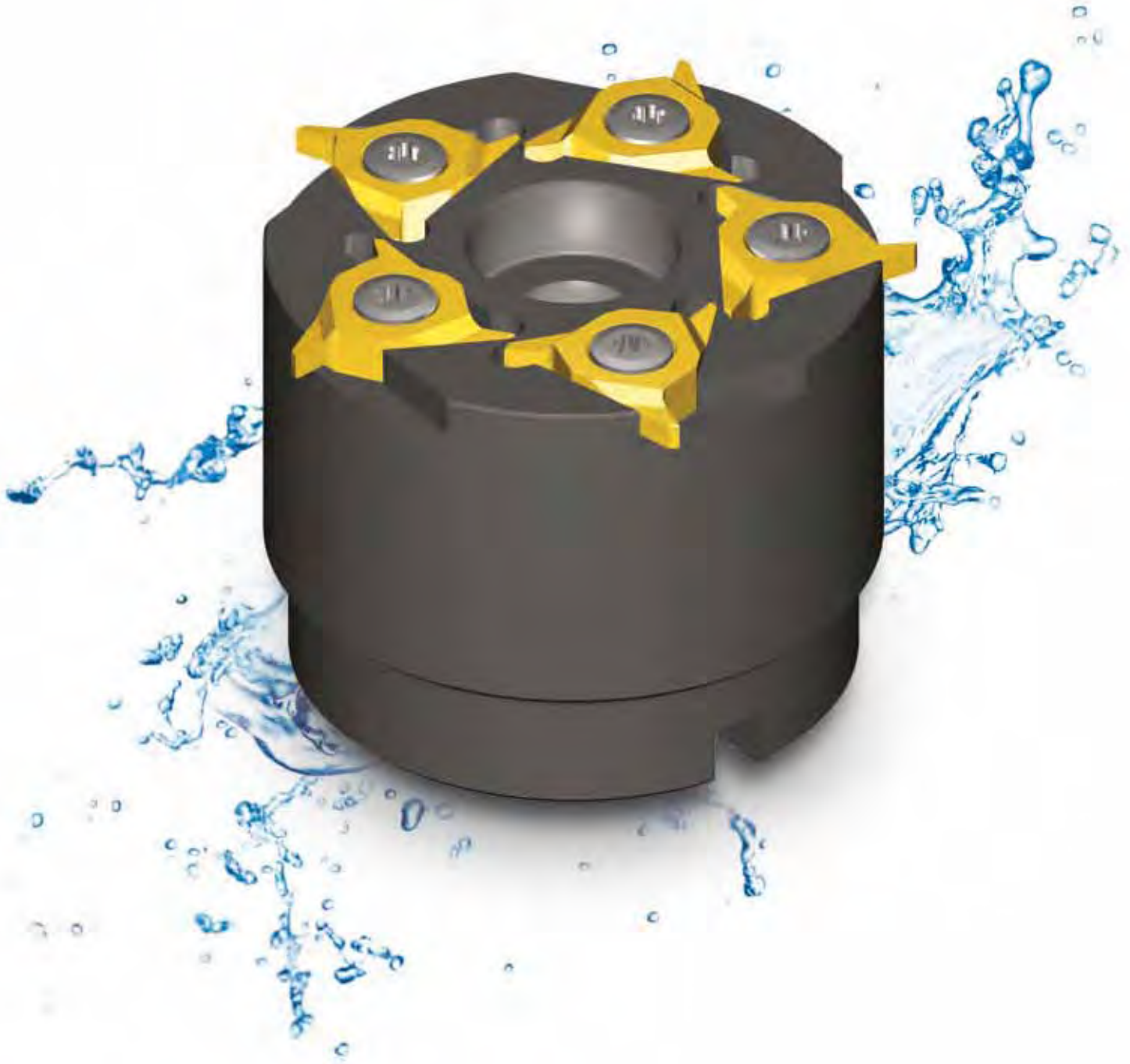

Stechfräsen

- > Schneidplatten
- > Trägerkörper
- > Technische Daten



Wendeplatten zum Nutfräsen

- Vardex Bestellnummern..... Seite 322
- Sicherungsring nicht normgerecht Seite 323
- Sicherungsring DIN 471 / 472 Seite 324
- O-Ring DIN 3770 Seite 324
- O-Ring BS 1806, DIN 3601, DIN 3771 Seite 325
- O-Ring BS 4518 Seite 325
- Stechfrässchäfte Seite 326
- Technische Daten - Stechfräsen Seite 328

Vardex Bestellnummernsystem

Stechfräsplatten

4	W	GM	1.6	C	-	D3770	S	-	1.38	VKX
1	2	3	4	5		6	7		8	9

1- Plattengröße	2- Schneidplattentyp	3- System	4- Nutbreite
4 - IC1/2"	W - Vertikalplatten	GM - Nutfräsen	1.1 - 3.15

5- Profilform	6- Stechen, Norm	7- Nut für	8- Nuttiefe
C - mit Fase	CIRC - Circlip DIN471/472 DIN3770D DIN3770S BS1806 BS4518	D - Dynamisch S - Statisch DP- Dynamisch pneumatisch DH- Dynamisch hydraulisch	0.3 - 3.8

9- Hartmetallsorte
VKX

Fräskopf für Nutfräsen

SGM	-	D48	-	25	-	4
1		2		3		4

1- System	2- SchneidenØ	3- Aufnahmebohrungsdurchmesser	4- Plattengröße
SGM - Shell Groove Milling	48, 63, 80	22, 25, 27	4 - IC1/2"

Sicherungsring nicht normgerecht

Außen / Innen

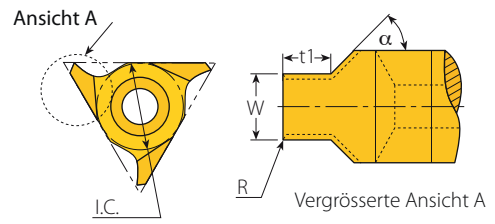
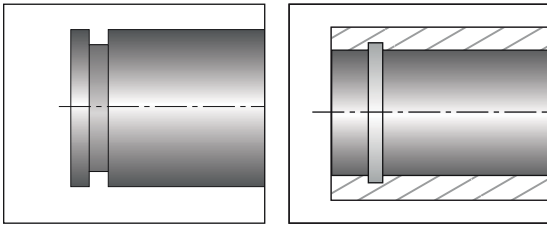

Vertikal SGM

Vertikal SGM

Plattengröße		Bestellnummer	Abmessungen mm			α	Trägerkörper
IC	L mm		W	R	t1		
1/2"	22	4WGM1.25C-CIRC-1.5...	1.25	0.2	1.3	45°	SGM-D...-4
		4WGM1.35C-CIRC-1.5...	1.35	0.2	1.3		
		4WGM1.45C-CIRC-1.5...	1.45	0.2	1.3		
		4WGM1.50C-CIRC-1.5...	1.50	0.2	1.3		
		4WGM1.65C-CIRC-2.0...	1.65	0.2	1.8		
		4WGM1.75C-CIRC-2.0...	1.75	0.2	1.8		
		4WGM1.85C-CIRC-2.50...	1.85	0.2	2.3		
		4WGM2.00C-CIRC-2.50...	2.00	0.2	2.3		
		4WGM2.20C-CIRC-3.50...	2.20	0.2	3.3		
		4WGM2.30C-CIRC-3.50...	2.30	0.2	3.3		
		4WGM2.50C-CIRC-3.50...	2.50	0.3	3.3		
		4WGM2.65C-CIRC-3.50...	2.65	0.3	3.3		
		4WGM2.70C-CIRC-3.50...	2.70	0.3	3.3		
		4WGM2.80C-CIRC-3.50...	2.80	0.3	3.3		
		4WGM3.00C-CIRC-3.50...	3.00	0.3	3.3		
		4WGM3.20C-CIRC-3.50...	3.20	0.3	3.3		
		4WGM3.30C-CIRC-3.50...	3.30	0.3	3.3		
		4WGM3.50C-CIRC-4.00...	3.50	0.3	3.8		
		4WGM3.70C-CIRC-4.00...	3.70	0.3	3.8		
		4WGM3.90C-CIRC-4.00...	3.90	0.3	3.8		
4WGM4.00C-CIRC-4.00...	4.00	0.3	3.8				



Sicherungsring DIN 471/472

Außen / Innen

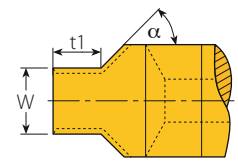
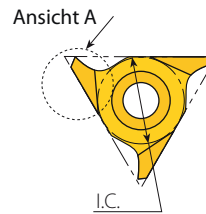
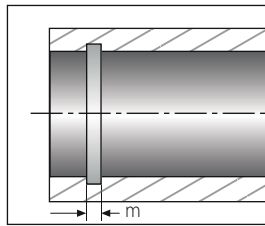
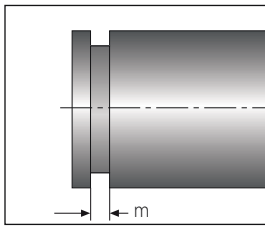

Vertikal SGM

Vertikal SGM

Plattengröße		Bestellnummer	Norm			α	Trägerkörper
IC	L mm	*m(H13)	W	t1			
1/2"	22	4WGM1.1C-D471/472-0.35...	1.10	1.19	0.3	45°	SGM-D...-4
		4WGM1.1C-D471/472-0.40...	1.10	1.19	0.4		
		4WGM1.3C-D471/472-0.50...	1.30	1.39	0.4		
		4WGM1.3C-D471/472-0.55...	1.30	1.39	0.5		
		4WGM1.6C-D471/472-0.70...	1.60	1.69	0.6		
		4WGM1.6C-D471/472-0.85...	1.60	1.69	0.8		
		4WGM1.6C-D471/472-1.00...	1.60	1.69	0.9		
		4WGM1.85C-D471/472-1.25...	1.85	1.94	1.1		
		4WGM1.85C-D471/472-1.00...	1.85	1.94	0.9		
		4WGM2.15C-D471/472-1.50...	2.15	2.24	1.4		
		4WGM2.65C-D471/472-1.50...	2.65	2.74	1.4		
		4WGM2.65C-D471/472-1.75...	2.65	2.74	1.6		
		4WGM3.15C-D471/472-1.75...	3.15	3.24	1.6		



O Ring DIN 3770

Außen / Innen

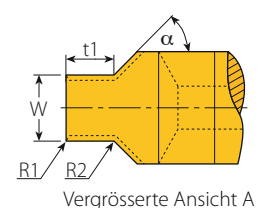
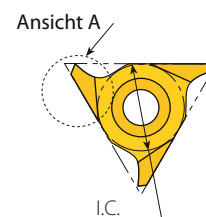
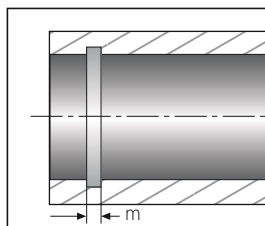
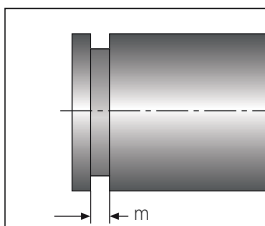

Vertikal SGM

Vertikal SGM

Plattengröße		Bestellnummer	Norm					α	Trägerkörper	
IC	L mm	St.Dy	*m(H13)	W	t	R1	R2			
1/2"	22	St.	4WGM1.6C-D3770S-1.38...	1.60	1.97	1.38	0.25	0.10	75°	SGM-D...-4
			4WGM2.0C-D3770S-1.72...	2.00	2.37	1.72	0.25	0.10		
			4WGM2.5C-D3770S-2.15...	2.50	3.02	2.15	0.25	0.10		
			4WGM3.15C-D3770S-2.70...	3.15	3.77	2.70	0.60	0.20		
		Dy.	4WGM1.6C-D3770D-1.47...	1.60	1.97	1.47	0.25	0.10		
			4WGM2.0C-D3770D-1.83...	2.00	2.37	1.83	0.25	0.10		



St. = Statisch

Dy. = Dynamisch

O Ring BS 1806, DIN3601, DIN 3771

Außen / Innen

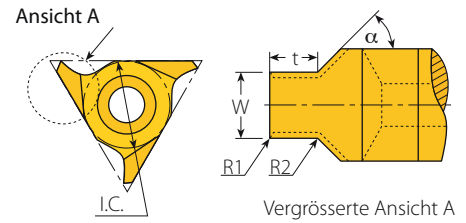
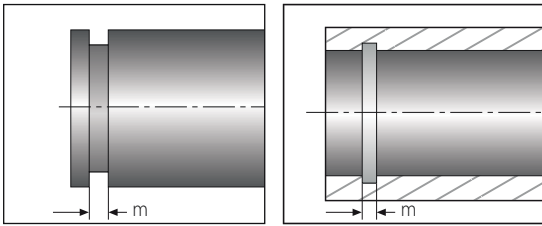

Vertikal SGM

Vertikal SGM



Plattengröße		Bestellnummer			Norm				α	Trägerkörper
IC	L mm	St.	Dy	*m(H13)	W	t	R1	R2		
1/2"	22	St.	4WGM1.80C-BS1806S-1.3...	1.80	2.37	1.30	0.6	0.2	75°	SGM-D...-4
			4WGM2.65C-BS1806S-2.0...	2.65	3.57	2.00	0.6	0.2		
		Dy.	4WGM1.80C-BS1806D-1.57...	1.80	2.37	1.55	0.6	0.2		
			4WGM2.65C-BS1806D-2.38...	2.65	3.57	2.30	0.6	0.2		

St. = Statisch
Dy. = Dynamisch

BS 4518

Außen / Innen

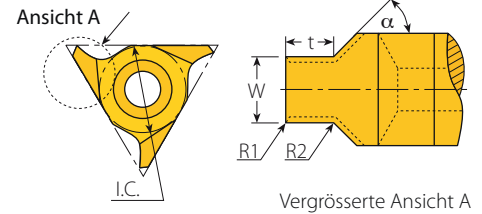
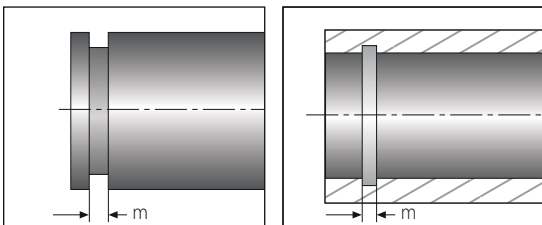

Vertikal SGM

Vertikal SGM



Plattengröße		Bestellnummer			Norm				α	Trägerkörper
IC	L mm	St.	Dy	*m(H13)	W	t	R1	R2		
1/2"	22	St.	4WGM1.6C-BS4518S-1.25...	1.60	2.37	1.25	0.5	0.2	75°	SGM-D...-4
			4WGM2.4C-BS4518S-1.95...	2.40	3.17	1.95	0.5	0.2		
			4WGM3.0C-BS4518S-2.51...	3.00	3.77	2.51	1.0	0.2		
		DyP	4WGM2.4C-BS4518DP-2.20...	2.40	3.27	2.20	0.5	0.2		
			4WGM3.0C-BS4518DP-2.77...	3.00	4.07	2.77	1.0	0.2		
			DyH	4WGM2.4C-BS4518DH-2.09...	2.40	3.27	2.09	0.5		
4WGM3.0C-BS4518DH-2.60...	3.00	4.07		2.60	1.0	0.2				

St. = Statisch
DyP = Dynamisch pneumatisch
DyH = Dynamisch hydraulisch

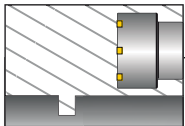

Schaftfräser

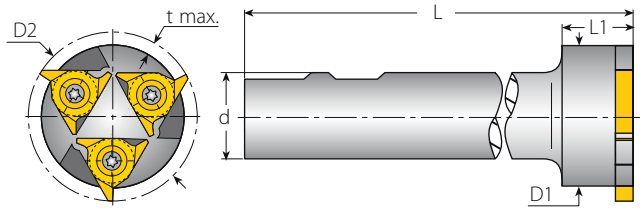

Schaftfräser

Ersatzteile

Plattengröße	Bestellnummer	Abmessungen mm							Ersatzteile	
IC		D2	t max.	L	L1	d	D1			
1/2"	SGM-D48-25-4	48	3.5	125	20	25	40	Plattenspannschraube SN4T-90	Torx Schlüssel HK4T	

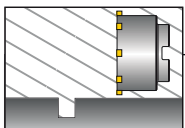

Fräskopf

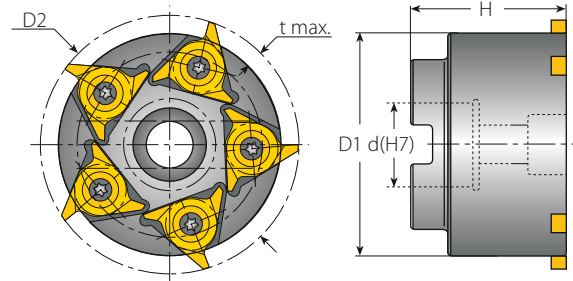

Fräskopf (5 Platten)

Ersatzteile

Plattengröße	Bestellnummer	Abmessungen mm					Ersatzteile		
IC		D2	t max.	d(H7)	D1	H			
1/2"	SGM-D63-22-4	63	3.5	22	54.0	41	Plattenspannschraube SN4T-90	Torx Schlüssel HK4T	Aufnahme M10x1.5x35

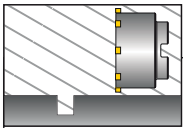

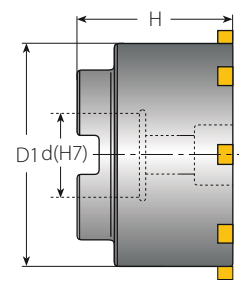
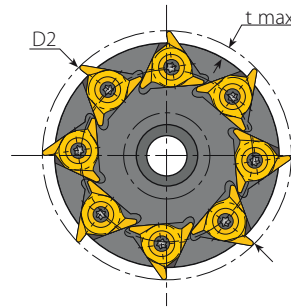

Fräskopf



Fräskopf (8 Platten)

Ersatzteile

Plattengröße	Bestellnummer	Abmessungen mm					Ersatzteile		
IC		D2	t max	d(H7)	D1	H			
1/2"	SGM-D80-27-4	80	3.5	27	72	50	SN4T-90	HK4T	M12x1.75x40

Empfohlene Sorten und Schnittgeschwindigkeiten Vc [m/min] und Vorschübe fz [mm/Zahn]

Materialgruppe	VarDEX Nr.	Material	Brinell Härte HB	Vc [m/min]	Vorschub fz [mm/Zahn]	
				VKX	fz	
P Stahl	1	Unlegierter Stahl	Geringer Kohlenstoffanteil (C=0.1-0.25%)	125	100-220	0.05-0.1
	2		Mittlerer Kohlenstoffanteil (C= 0.25- 0.55%)	150	100-170	0.03-0.07
	3		Hoher Kohlenstoffanteil (C= 0.55- 0.85%)	170	100-160	0.02-0.05
	4	Niedriglegierter Stahl (Legierungs- Elemente ≤ 5%)	Ungehärtet	180	80-150	0.05-0.09
	5		Gehärtet	275	70-140	0.03-0.07
	6		Gehärtet	350	70-130	0.02-0.05
	7	Hochlegierter Stahl (Legierungs- Elemente > 5%)	Vergütet	200	70-120	0.03-0.07
	8		Gehärtet	325	70-100	0.03-0.05
	9	Stahlguss	Niedriglegiert (Legierungs- Elemente ≤ 5%)	200	70-110	0.03-0.05
	10		Hochlegiert (Legierungs- Elemente > 5%)	225	50-80	0.02-0.05
M Edelstahl	11	Edelstahl Ferritisch	Ungehärtet	200	80-150	0.03-0.07
	12		Gehärtet	330	80-150	0.03-0.05
	13	Edelstahl Austenitisch	Austenitisch	180	60-120	0.03-0.07
	14		Super- Austenitisch	200	60-120	0.03-0.05
	15	Edelstahl	Ungehärtet	200	60-120	0.02-0.05
	16		Gehärtet	330	60-120	0.01-0.03
	17	Edelstahl Guss austenitisch	Austenitisch	200	50-100	0.03-0.05
	18		Gehärtet	330	50-100	0.01-0.03
K Gußeisen	28	Temperguss	Ferritisch (kurzspanig)	130	60-110	0.02-0.05
	29		Perlitisch (langspanig)	230	50-100	0.01-0.03
	30	Grauguss	Niedrigfest	180	60-110	0.03-0.07
	31		Hochfest	260	50-80	0.03-0.05
	32	Kugelgraphitguss	Ferritisch	160	50-100	0.03-0.05
	33		Perlitisch	260	40-70	0.03-0.05
N(K) Nichteisen- Metalle	34	Aluminium- Legierungen Schmiedeeisen	ungealtert	60	100-200	0.07-0.15
	35		gealtert	100	100-150	0.03-0.05
	36	Aluminium- Legierungen	Guß	75	100-180	0.07-0.15
	37		Guß & gealtert	90	60-120	0.05-0.1
	38	Aluminium- Legierungen	Guß Si 13- 22%	130	100-150	0.05-0.1
	39	Kupfer und Kupferlegierungen	Messing	90	60-120	0.05-0.1
40	Bronze und bleifreies Kupfer		100	50-100	0.3-0.08	
S(M) Hitzebeständige Material	19	Hochtemperaturlegierungen	Vergütet (Eisen basiert)	200	20-45	0.01-0.03
	20		Gealtert (Eisen basiert)	280	20-30	0.01-0.03
	21		Vergütet (Nickel oder Cobalt basiert)	250	10-20	0.01-0.03
	22		Gealtert (Nickel oder Cobalt basiert)	350	10-15	0.01-0.03
	23	Titanlegierungen	Reines 99,5 Ti	400Rm	60-120	0.02-0.05
	24		α+β Legierungen	1050Rm	20-50	0.01-0.03
H(K) Gehärtetes Material	25	Extra harter Stahl	Gehärtet & angelassen	45-50HRc	15-45	0.05-0.1
	26			51-55HRc	15-40	0.05-0.1

* Vorschub an der Schneidkante

$$n = \frac{1000 \times Vc}{\pi \times D} \quad Vc = \frac{n \times \pi \times D}{1000}$$

Sorten und ihre Anwendungen

Sorte	Anwendung	Beispiel
VKX	Ausgezeichnete Sorte für allgemeine Verwendung TIN beschichtet.	

- n - Drehzahl [U/min.]
- Vc - Schnittgeschwindigkeit [m/min.]
- D - Schneidendurchmesser [mm]
- Vf1 - Vorschub an der Schneidkante [mm/min.]
- z - Anzahl der Schneiden
- fz - Vorschub pro Zahn und Umdrehung [mm/U]

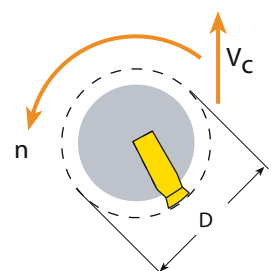













V A R G U S W E L T W E I T



Vargus Ltd. Headquarters ☎ +972 4 9855101 mrktg@vargus.com

	China	Vargus China Neumo-Vargus (Shanghai) Trading Co. Ltd.	☎ +86 215239 5005/6/9	info@varguschina.net
	Denmark	Vargus Denmark Damstahl Tooling A/S	☎ +45 8794 4100	tooling@damstahl.com
	France	Vargus France	☎ +33 1 4601 7060	commercial@vargus.fr
	Germany	Vargus Germany	☎ +49 7043 36 161	info@vargus.de
	India	Vargus India	☎ +91 98990 73393	prasad@vargusindia.com
	Israel	Vargus Israel Neumo-Vargus Marketing Ltd	☎ +972 3 537 3275	neumo@neumo-vargus.co.il
	Poland	Vargus Poland Neumo-Polska Sp. Z.O.O.	☎ +48 46 834 9904 ☎ +48 603 888 064	vargus@neumo.pl
	Switzerland	Vargus Switzerland Werkzeugtechnik (Snel AG)	☎ +41 41784 2121	info@vargus.ch
	United Kingdom	Vargus Tooling UK Ltd.	☎ +1 44 1952 583 222	tooling.uk@vargustooling.co.uk
	USA	Vargus USA Vardex USA	☎ +1 800 828 8765 ☎ +608 756 4930	sales@vargususa.com

Für eine komplette Liste der weltweiten Vargus-Händler, besuchen Sie unsere Internetseite unter www.vargus.de



TT GEN und TM GEN

Gewindedreh- und Gewindefrässsoftware für eine erleichterte Werkzeugauswahl und die Erstellung von CNC-Programmen
Die neuesten Versionen finden Sie unter www.vargus.de

VARDEX
Fortschrittliche Gewindelösungen

vargus
NEUMO Ehrenberg Group

**Germany
Vargus Deutschland**

Tel: +49 (0) 7043 / 36-161
Fax: +49 (0) 7043 / 36-160
E-mail: info@vargus.de
www.vargus.de

**Switzerland
Vargus Werkzeugtechnik SNEL AG**

Tel: +41 (0) 41784 2121
Fax: +41 (0) 41784 2139
E-mail: info@vargus.ch
www.vargus.ch

**Austria
SWT Schlager Werkzeugtechnik**

Tel. +43 (7252) 220 120
Fax +43 (7252) 220 129
E-mail: office@swt.co.at
www.swt.co.at

maXmark
METRIC GN

Towlit Design Group Ltd.

221-01000
METRIC GN
08 / 2010
EDITION 01